

PROPOSED



January  
2025  
Edition

# Engineering & Design Standards Manual

for Public Works Construction



December 19, 2024

**Subject: Standard Details, Specifications and Engineering & Design Standards Manual**

Please be advised, effective January 27, 2025, all new (1<sup>st</sup> Review) improvement plan submittals will be subject to the January 2025 update to the Standard Details, Specifications and Engineering & Design Standards Manual and the 2025 revisions to MAG Specifications and Details. See the attached change summary for a detailed listing of revisions.

Current manuals are available on the City Unified Development Manual website [HERE](#) or purchased in hard copy format from the Development Services front counter at 215 E. Buffalo Street.

If you have further questions, please contact Warren White at (480) 782-3337.

Sincerely,

A handwritten signature in black ink, appearing to read "John Knudson".

John Knudson, PE  
Public Works & Utilities Director\City Engineer

Attachment: Change Summary January 2025



## Engineering Standards Change Summary January 2025

### Design Standards Manual

<u>Document No.</u>	<u>Title</u>	<u>Revision Summary</u>
Chapter 1	Water System Design	Various revisions to clarify and enhance existing requirements including private on site hydrants, dead end public water mains, manifold multiple meters, multi-family firelines and secondary potable water meter connection for redundancy, commercial firelines, and fire pumps for industrial sites. Three new figures added, 1-A, 1-B and 1-C.
Chapter 1	Water System Design	Revision to Section 1.2.3.1, B - Design Reports, removing conflicting sentence that was carryover from past version "System pressures may range from 50 to 100 psi with velocity less than 5 feet per second for peak hour flow."
Chapter 1	Water System Design	Revision to Section 1.2.3.1, A - Minimum Pressure, removing sentence "... in lieu of fire hydrant flow test results." Fire hydrant flow tests are still required, but covered under Section B. Design Reports. This was causing some confusion.
Chapter 2	Wastewater and Reclaimed System Design	Revision to Section 2.2.9 Manholes, clarification on requirements for new MH connections and connections at existing stub-outs (first paragraph). Reordered this section and moved industrial monitoring vaults to new Section 2.2.11 Pre-Treatment Requirements.
Chapter 2	Wastewater and Reclaimed System Design	Revisions for new MAG Section 632 tracer wire requirements, various locations. Other insertions for missing MAG references for pipe installation, Section 615, etc.
Chapter 3	Storm Drainage System Design	Revisions to drywell registration per changes from ADEQ to EPA. Requiring registration numbers to be delivered at the time of project acceptance.
Chapter 4	Street Design and Access Control	Add language to 4.6 Access Management: "Any gate(s) on a residential driveway on an arterial or collector road are to be located a minimum of 23 feet from back-of-curb (25 feet from roadway asphalt). This is to provide space for a typical vehicle stopped prior to the gate to be out of the roadway." Also, revise Residential Driveway definition on pg 82, "New access from an arterial street is not allowed" and on pg 108, revise paragraph under 4.6.1 Access Control related to single family residences as follows "New single family residences are not allowed direct access to arterial streets."
Chapter 4	Street Design and Access Control	Revisions to Section 4.4.1 Signing & Striping pertaining to typical RR Crossings and Quiet Zone requirements, more guidance provided. Removing Figure 4-H in favor of new City Detail C-625, Railroad Markings for Quiet Zones.
Chapter 4	Street Design and Access Control	Revision to Section 4.6.3 Emergency Access Requirements, clarifying FD placement requirements and additional standard requirements.
Chapter 5	Traffic Signal Design	Revised Figure 5-E to clarify (2) 4"PVC Signal Conduits
Chapter 6	Streetlight Design	Revisions to Photocells for new standards related to LED Control Nodes, revised wattage for luminaires (Section 6.3.2), revised pole painting per APL and added requirement for GPS location for all new and relocated poles.
Chapter 7	Traffic Barricade Design	Revisions for off duty officers in Section 7.6.5.1 Police Officers, "To schedule extra-duty officers for traffic control during construction or maintenance operations visit <a href="https://odm.officertrak.com/Chandler-AZ-PD">https://odm.officertrak.com/Chandler-AZ-PD</a> or call 1-877-636-8300." This replaces the first sentence in the second paragraph.
Chapter 8	Landscape Design of City Owned R.O.W., Medians, and Retention Basins	Revise Section 8.2.11 Irrigation Systems to include current requirements for reclaimed or potable for medians.

### Specifications and Standard Details Manual (Supplement to MAG)

<u>Document No.</u>	<u>Title</u>	<u>Revision Summary</u>
TOC	Details C-759-1 and C-759-2	Blooper: Remove reference to these details since never created. Was decided not to add these SRP and APS trench and backfill details but instead require developer to coordinate with appropriate utility company as stated in the Eng Design Manual.
C-103-1	Pull Box No. 7 Typical Installation	Separated notes 3 & 4: Note 3 - Changed to reflect only on the vault Note 4 - Added note to specify the type of lid required Adjusted leaders to reflect new note numbers. Other minor adjustments to drawing.
C-103-2	Pull Box No. 9 Typical Installation	Added note 15. Other minor adjustments to drawing.
C-103-3	Pull Box No. 9 Split Vault Typical Installation	Added note 15. Other minor adjustments to drawing.
C-104-1	Open Trench Fiber Optic Cable Ducts	Changed drawing number. Made minor adjustments to drawing.
C-104-2	Horizontal Directional Drilling Fiber Optic Cable Ducts	New detail for horizontal directional drilling.
C-208	Industrial Collector Street Typical Cross Section	Remove this detail since no longer in use. Current standard is C-210. Removed Industrial Collector definition in Eng Design Standards Manual Ch 4.
C-214	Private Shared Driveway Typical Cross Section & Utilities	Typo in note no. 4, roll curb should be MAG Detail 220-1 (Type C), not 200-1. Revise water main location to 6' off C.L.
C-243	Curb Ramp for Rolled Curb	Blooper: This detail was removed in past update, just needs to be removed from final PDF. Was removed in favor of MAG Detail 238-4, Single Curb Ramp Mid-Block Residential Street W/ 4" Roll Curb.
C-260-2	On-Street Parking Accessible Spaces	Remove detectable warning shown on all ramp details and revise notes 8 and 9 stating "DO NOT INSTALL DETECTABLE WARNING". Final PROWAG states detectable warning is not required for ramps that serve ADA spaces exclusively.
C-260-2	On-Street Parking Accessible Spaces	Added additional ramp and access aisle based on final PROWAG where shared aisle no longer allowed for angled parking.

C-261-1	Passenger Loading Zones for Autonomous Vehicles and Ride Sharing	Revise note 5, "CURB RAMPS SERVING PASSENGER LOADING ZONES DO NOT REQUIRE DETECTABLE WARNING". Final PROWAG states detectable warning is not required for ramps that serve ADA spaces exclusively.
C-301-1	Water Service Installation	Revisions for PEXa pipe allowance and other minor revisions
C-301-2	Multi-Meter Water Service Installation	Revise/move fireline backflow and note 5 to outside of right-of-way.
C-307	Valve Box Installation (Potable Water)	Revision to note regarding 'non-pop' polymer lid requirement. Revised to "VALVE LID PER LIST OF APPROVED PRODUCTS". Non-pop polymer lids no longer acceptable due to ongoing durability issues. Also, corrected spec reference in note 2 for CLSM to MAG Section 728. Removing tracer wire per new MAG Section 632.
C-311	Reduced Pressure-Principle Backflow Prevention Assembly Installation - 3" and Under	Revisions to notes adding reference to APL, certified testing, 2' clear space and not painting brass parts or placards.
C-315	Reduced Pressure-Principle Backflow Prevention Assembly Installation - 4" and Larger	Revisions to notes adding reference to APL, certified testing, 2' clear space and not painting brass parts or placards. Also, clarification of 6" max distance.
C-319	2" Combination Air/Vacuum Valve Assembly	Revisions based on current approved product: removed mesh screen and 90 elbow on top. Revised box to polymer concrete and only 1 required.
C-400	Manhole Frame and Cover Types	Revisions to graphics and notes based on current approved MH frame and cover.
C-406-1	Valve Box Installation (Reclaimed Water)	Revision to note 2 to correct CLSM spec to MAG Section 728.
C-408	Pipe Locator Wire & I.D. Tape	Remove this in favor of new MAG Detail 399-1. Revised Design Manual for references to C-408 too.
C-506	Catch Basin Grates	Typo in title
C-602	Collector Road Pavement Markings	Renumber to detail to C-624 to keep with other details pertaining to markings.
C-625	Railroad Markings for Quiet Zones	New detail to replace Figure 4-H in Eng Design Standards Manual Ch 4.
C-718	Chandler Pole Foundation QC, RC, JC MOD, KC, & KC MOD	Adding note 6. "See ADOT Std Dwg T-SL 4.28 for additional anchor bolt dimensions.:
C-724	Traffic Signal Pull Box No. 7 Typical Installation	New detail specific to pull box requirements for traffic signals.
C-756	Angle Street Light Pole (SL-17)	Revise 2" MIN. note in plan view to remove MIN.
C-758	Street Light Connection Details	Revise title to include reference to previous SL-15 detail as with other details.
FD102	FIRE LINE INSTALLATION (ON-SITE HYDRANT REQUIRED)	Revisions to add flow detection meter notes.
FD103	FIRE LINE INSTALLATION (NO ON-SITE HYDRANTS REQUIRED)	Revisions to add flow detection meter notes.

# Table of Contents

<b>Introduction.....</b>	<b>1</b>		
<b>Chapter 1 - Water System Design .....</b>	<b>3</b>		
1.1 General Information .....	3		
1.1.1 Potable Water .....	3		
1.1.2 Definitions .....	4		
1.1.3 Standard Specifications and Details .....	8		
1.2 Potable Water Distribution and Transmission System .....	9		
1.2.1 Water Main Requirements .....	9		
1.2.2 Water Transmission System – Additional Design Criteria.....	14		
1.2.3 Public Water Distribution System – Additional Design Criteria.....	15		
1.2.4 Commercial Potable Water Distribution System .....	19		
<b>Chapter 2 - Wastewater and Reclaimed System Design .....</b>	<b>26</b>		
2.1 General Information .....	26		
2.1.1 Sanitary Sewer .....	26		
2.1.2 Definitions .....	28		
2.1.3 Standard Specifications and Details .....	28		
2.2 Wastewater Collection System .....	28		
2.2.1 Jurisdictional Agency Approval ...	28		
2.2.2 Engineering Requirements.....	29		
2.2.3 Easement Requirements.....	30		
2.2.4 Construction Plan Requirements	31		
2.2.5 Design Flows .....	31		
2.2.6 Pipe Materials .....	33		
2.2.7 Gravity Sewer Lines.....	33		
2.2.8 Force Mains.....	35		
2.2.9 Manholes .....	35		
2.2.10 Service Connections.....	36		
2.2.11 Pre-Treatment Requirements.....	37		
2.3 Reclaimed Water Distribution System	38		
2.3.1 Jurisdictional Agency Approval ...	38		
2.3.2 Engineering Requirements.....	38		
2.3.3 Easement Requirements.....	39		
2.3.4 Pressure Considerations .....	40		
2.3.5 Applicable Design Criteria based on Location within Service Area .....	41		
2.3.6 Location.....	43		
2.3.7 Acceptable Pipe Materials and Construction Requirements .....	43		
2.3.8 Reclaimed Water Lines .....	43		
2.3.9 Construction Plan Requirements	43		
2.3.10 Private Reclaimed Water System Design Considerations.....	44		
2.3.11 Reclaimed Water Service Process .....	46		
<b>Chapter 3 - Storm Drainage System Design.....</b>	<b>49</b>		
3.1 General Information .....	49		
3.1.1 Disclaimer.....	49		
3.1.2 Definitions.....	49		
3.2 Planning .....	52		
3.3 Policies .....	52		
3.3.1 Purpose .....	52		
3.3.2 General.....	52		
3.3.3 Planning.....	52		
3.3.4 Drainage Patterns & Outfall.....	52		
3.3.5 Hydrology.....	53		
3.3.6 Stormwater Quality.....	53		
3.3.7 Floodplain Management.....	54		
3.3.8 Erosion Hazard Management .....	54		
3.3.9 Street Drainage .....	54		
3.3.10 Conveyance Facilities .....	54		
3.3.11 Storage Facilities .....	54		
3.3.12 Stormwater Dissipation .....	55		
3.3.13 Ownership and Maintenance of Facilities .....	55		
3.3.14 Erosion and Sediment Control During Construction .....	55		
3.3.15 Post Construction Stormwater Management .....	55		
3.3.16 Capital Improvement and Redevelopment/Infill Projects....	56		
3.4 Regulations (Federal, State, AND County) .....	56		
3.5 Regulations/Ordinances.....	56		

Table of Contents

3.5.1	Introduction .....	56	4.2.12	Bus Shelters.....	101
3.5.2	City Code Section 45 – Storm Drainage Requirements.....	57	4.2.13	Passenger Loading Zones (Autonomous Vehicles and Ride Sharing).....	101
3.5.3	City Code Section 43-5 – Floodplain Regulation.....	58	4.3	Pavement structural design .....	103
3.5.4	City Code Section 35 – Zoning Ordinance .....	58	4.3.1	Flexible Pavement.....	103
3.5.5	City Code Section 48 – Subdivision Regulation.....	58	4.3.2	Rigid Pavement .....	103
3.5.6	Permits .....	58	4.3.3	Decorative Pavement.....	103
3.6	Standards .....	58	4.3.4	Miscellaneous Pavement Standards .....	103
3.6.1	Public Safety.....	58	4.4	Traffic control devices.....	103
3.6.2	Hydrology .....	59	4.4.1	Signing & Striping .....	103
3.6.3	Construction Site Stormwater Runoff Control .....	63	4.4.2	Half Road Standards.....	105
3.6.4	Street Drainage .....	65	4.4.3	On-Street Parking with Bulb-Outs .....	105
3.6.5	Storm Drains .....	66	4.4.4	Accessible Parking Spaces .....	106
3.6.6	Equalizers, Culverts, and Bridges	68	4.4.5	Traffic Signals .....	108
3.6.7	On-Site.....	68	4.4.6	Traffic Calming .....	108
3.6.8	Open Channels .....	69	4.5	Traffic impact studies.....	108
3.6.9	Hydraulic Structures.....	69	4.6	access management.....	109
3.6.10	Stormwater Storage.....	69	4.6.1	Access Control.....	109
3.6.11	Pump Stations .....	76	4.6.2	Location and Number of Access Points.....	109
3.6.12	Sedimentation Maintenance .....	76	4.6.3	Emergency Access Requirements .....	110
3.6.13	Hydrology and Hydraulics Reports (Non-FIS).....	78	4.6.4	Driveway Spacing and Storage..	111
3.6.14	General Construction Drawing Requirements .....	81	4.6.5	Driveway Widths.....	114
3.6.15	References .....	81	4.6.6	Curb Return Radii.....	114
<b>Chapter 4 -</b>	<b>Street Design and Access Control.....</b>	<b>83</b>	4.7	ada upgrade requirements .....	114
4.1	general information .....	83	4.7.1	ADA Curb Ramps .....	114
4.1.1	Definitions .....	83	4.7.2	ADA Sidewalks.....	117
4.1.2	General.....	85	4.8	plan submission requirements.....	118
4.2	Road Elements .....	85	<b>Chapter 5 -</b>	<b>Traffic Signal Design.....</b>	<b>120</b>
4.2.1	Alignment.....	85	5.1	general information .....	120
4.2.2	Road and Right-of-Way Widths...	89	5.2	developer’s checklist.....	120
4.2.3	Parking .....	94	5.3	Electrical services .....	121
4.2.4	Intersections .....	94	5.4	plan development.....	122
4.2.5	Clearance to Obstructions .....	96	5.5	signal poles.....	129
4.2.6	Medians.....	97	5.5.1	Signal Pole Types.....	129
4.2.7	Sidewalks.....	98	5.5.2	Pole and Pushbutton Placement .....	129
4.2.8	Street Lights .....	98	5.6	Pull Boxes .....	129
4.2.9	Drainage .....	98	5.7	conduits and conductors.....	130
4.2.10	Deceleration Lanes.....	99			
4.2.11	Bus Bays .....	100			



Table of Contents

5.7.1	Conduit.....	130	6.6	conductors .....	148
5.7.2	Conductors.....	131	6.7	trenching and backfill (SRP AND APS SERVICE AREAS) .....	148
5.7.3	Communication Cables .....	133	6.8	conduits.....	148
5.7.4	Fiber Support Equipment.....	134	6.9	traffic control .....	149
5.8	controller and cabinet.....	134	6.10	streetlight energization for subdivisions in srp area .....	149
5.8.1	Controller .....	134	6.10.1	CITY OF CHANDLER .....	149
5.8.2	Cabinet .....	134	6.10.2	DEVELOPER/CONTRACTOR .....	149
5.8.3	GPS .....	134	6.10.3	SALT RIVER PROJECT .....	150
5.8.4	ARID Device.....	134	<b>Chapter 7 -</b>	<b>Traffic Barricade Design.....</b>	<b>151</b>
5.9	Detectors.....	135	7.1	general information .....	151
5.9.1	Video Detection .....	135	7.2	Purpose of barricading and channelization .....	151
5.9.2	Pre-emption Equipment.....	135	7.3	permission to restrict city streets and sidewalks .....	151
5.10	CCtv camera .....	135	7.3.1	Requests.....	151
5.11	signal heads.....	135	7.3.2	Traffic Control Plan .....	152
5.11.1	Placement of Signal Heads.....	135	7.3.3	Notice for Restrictions .....	152
5.11.2	Signal Lamps.....	135	7.3.4	Alley Restrictions or Closures....	152
5.12	internally iluminated street name signs .....	136	7.3.5	Road Restrictions and Closures Permit .....	152
<b>Chapter 6 -</b>	<b>Streetlight Design .....</b>	<b>139</b>	7.3.6	Work Zone Traffic Control.....	152
6.1	general information .....	139	7.3.7	Construction Signs .....	153
6.1.1	Standards .....	139	7.4	General traffic regulations.....	153
6.2	service areas.....	142	7.5	existing traffic control devices .....	155
6.3	Luminaires.....	142	7.5.1	Traffic Signs .....	155
6.3.1	General.....	142	7.5.2	Traffic Signals .....	156
6.3.2	LED Luminaires.....	142	7.5.3	Pavement Markings .....	157
6.3.3	LED City Touch (CT) Control Nodes (Photocells).....	143	7.6	temporary traffic control devices .....	157
6.4	CT Control Nodes must be commissioned to the City of Chandler with a 10-year City Touch service agreement and 10-year system hardware warranty. poles .....	144	7.6.1	Signs .....	158
6.4.1	Pole Fabrication .....	144	7.6.2	Barricades and Channelizing Devices.....	168
6.4.2	Pole Preparation, Painting, and Identification .....	146	7.6.3	High Level Warning Devices.....	175
6.4.3	Approved Manufacturers.....	146	7.6.4	Pavement Markings .....	177
6.4.4	Wood Poles .....	146	7.6.5	Police Officers and Flaggers.....	178
6.4.5	Pole Bases .....	147	7.6.6	Temporary Traffic Signals.....	180
6.5	junction boxes.....	147	7.6.7	Portable Barriers .....	181
6.5.1	Installation .....	147	7.7	pedestran walkways and construction fences.....	181
6.5.2	SRP Service Area Junction Box..	147	7.7.1	Covered Pedestrian Walkways..	185
6.5.3	APS Service Area Junction Box..	147	7.7.2	Construction Fences.....	186
			7.7.3	Sight Distance Requirements....	186
			7.8	surveyors.....	190

Table of Contents

7.9 Service vehicles ..... 193

7.10 barricading illustrations ..... 195

**Chapter 8 - Landscape Design of City Owned R.O.W., Medians, and Retention Basins .....213**

8.1 General information..... 213

8.1.1 Purpose ..... 213

8.1.2 Submittal Procedures, Review, and Scheduling ..... 214

8.1.3 Landscape Plan Requirements.. 215

8.1.4 As-Built Drawings ..... 216

8.2 general landscape standards ..... 216

8.2.1 General Design Considerations. 216

8.2.2 Materials - General ..... 216

8.2.3 Plant Materials ..... 217

8.2.4 Inert Materials ..... 220

8.2.5 Turf Grasses/Lawn ..... 220

8.2.6 Soil Testing ..... 222

8.2.7 Moisture Content..... 223

8.2.8 Topsoil..... 223

8.2.9 Finish Grading ..... 223

8.2.10 Utilities and Irrigations Systems 223

8.2.11 Irrigation Systems ..... 224

8.2.12 Operation and Maintenance Manual..... 231

8.2.13 Street Lighting and Accent Lighting ..... 232

8.2.14 Fences/Walls or Other Structures ..... 232

8.3 additional specifications for city owned retention basins..... 233

8.3.1 Design Considerations..... 233

8.3.2 Grading and Mounding ..... 234

8.3.3 Drywells..... 234

8.3.4 Plant Materials ..... 235

8.3.5 Lawn Construction Materials .... 235

8.4 additional specifications for rights-of-way and medians ..... 236

8.4.1 General..... 236

8.4.2 Design Guidelines..... 237

8.4.3 Planting of Trees, Shrubs, and Ground Cover ..... 239

8.4.4 Decorative Pavers ..... 243

8.4.5 Transit Facilities..... 243

**Chapter 9 - Survey and Vertical Control**

Benchmarks ..... 244

9.1 Vertical Control ..... 244



# List of Figures

Figure 1-A Multi-Family Fireline Layout .....	20
Figure 2-A Reclaimed Service Area.....	28
Figure 2-B System Pressure Criteria .....	40
Figure 2-C Exhibit D Amendment No. 1 (Ocotillo Management Group/Chandler Reclaimed Water Agreement).....	42
Figure 3-A 100 Year, 2-hour Precipitation Curve (ref: DDM Vol. I Sec. 2.4.1).....	61
Figure 3-B Downtown Drainage Areas .....	71
Figure 4-A Bubbles for Streets.....	88
Figure 4-B Design Aid for Major Intersection Cross-Section .....	89
Figure 4-C Cluster Configuration Options.....	93
Figure 4-D Triangle Area.....	96
Figure 4-E Typical Median Nose Location .....	97
Figure 4-F Median Nose at Driveway Entrance .....	98
Figure 4-G Passenger Loading Zone Types.....	102
Figure 4-H Street Furniture and Utility Locations .....	106
Figure 4-I Typical On-Street Parking Cross Section.....	107
Figure 4-J Minimum Turning Radii for Temporary Turn-Around and On-Site Roadways Providing Emergency Vehicle Access .....	110
Figure 4-K Driveway Spacing Along Arterials and Collector Streets .....	113
Figure 4-L Capital Improvement Project Curb Ramp Replacement Requirements.....	116
Figure 4-M Private Development Project Curb Ramp Replacement Requirements .....	117
Figure 5-A Electrical Services Boundary Map .....	122
Figure 5-B Plan Symbols (Part One).....	125
Figure 5-C Plan Symbols (Part Two).....	126
Figure 5-D Cabinet and Pole Schedule .....	128
Figure 5-E Pull Box and Conduit Locations .....	132
Figure 5-F Signal Head Placement With Left Turn Phase.....	137
Figure 5-G Signal Head Placement Without Left Turn Phase .....	138
Figure 7-A Regulatory Signs .....	161
Figure 7-B Regulatory and Guide Signs .....	162
Figure 7-C Warning Signs .....	166
Figure 7-D Warning Signs.....	167
Figure 7-E Barricades and Channelizing Devices .....	171
Figure 7-F Flagging Procedures .....	180
Figure 7-G Sidewalk Closures .....	184
Figure 7-H Covered Pedestrian Walkway .....	188
Figure 7-I Construction Fences.....	189
Figure 7-J Surveying Intersection.....	191
Figure 7-K Surveying Midblock .....	192
Figure 7-L Service Vehicle Flasher Requirements .....	194
Figure 7-M Complete Street Closures.....	196
Figure 7-N Mandatory Turn Lane Closures.....	197
Figure 7-O Left Lane Closed Intersection Left Turn Lane Open.....	198

*List of Figures*

---

Figure 7-P Left Lane Closed Intersection – Two Lanes Open Using Left Turn Lane ..... 199  
Figure 7-Q Left Lane Closed Midblock – Two Lanes Open Using Left Turn Lane ..... 200  
Figure 7-R Center Lane Closed Intersection – Two Lanes Open ..... 201  
Figure 7-S Right Lane Closed Intersection – Two Lanes Open ..... 202  
Figure 7-T Right Lane Closed Intersection – Right Turn Lane Open ..... 203  
Figure 7-U Right Lane Closed Intersection – Two Lanes Open Using Left Turn Lane ..... 204  
Figure 7-V Right Lane Closed Intersection – Two Lanes Open Using Left Turn Lane – Right Turn Lane Open..... 205  
Figure 7-W Right Lane Closed Midblock – Two Lanes Open Using Left Turn Lane ..... 206  
Figure 7-X Two Right Lanes Closed Midblock ..... 207  
Figure 7-Y Two Right Lanes Closed Midblock – Two Lanes Open Using Left Turn Lane..... 208  
Figure 7-Z Half Street Closed Traffic Across Centerline ..... 209  
Figure 7-AA Half Street Closed Traffic Through Raised Median..... 210  
Figure 7-BB Flagging Station in Construction Area ..... 211  
Figure 7-CC Freeway and Expressway Right Lane Closure ..... 212  
Figure 9-A Survey Benchmarks..... 252

# List of Tables

Table 2.1 Wastewater Service Factors .....	32
Table 2.2 Population Factors .....	33
Table 2.3 Minimum Service Tap Sizes.....	37
Table 2.4 Development Location Design Criteria .....	41
Table 3.1 2-Hour Stormwater Distribution for Stormwater Storage Design (2.2 " of precip) (ref: DDM Vol. I Sec. 2.4.1) .....	60
Table 3.2 Intensity Duration Frequency Values.....	61
Table 3.3 Intensity Duration Coefficients .....	62
Table 3.4 Runoff Lag Times .....	62
Table 3.5 Runoff Coefficients for Rational Method.....	63
Table 3.6 Weighted Runoff Coefficient (includes R/W and pavement) .....	63
Table 3.7 Minimum RGRCP Pipe Class .....	67
Table 3.8 Basin Precipitation Depth.....	70
Table 4.1 Summary of Design Standards.....	87
Table 4.2 Minimum Width Requirements for Private Streets .....	91
Table 4.3 Typical Intersection Curb Return Radii .....	95
Table 4.4 Driveway Widths (to-face-of-curb) .....	114
Table 4.5 Driveway Curb Return Radii (to-face-of-curb) .....	114
Table 5.1 Conductor Schedule.....	127
Table 5.2 Tenon Schedule .....	129
Table 5.3 Fiber Optic Communication Cable Specifications .....	133
Table 6.1 Illumination Standards .....	141
Table 7.1 Formulas for Taper Length and Distance between Devices.....	168
Table 9.1 Vertical Control Benchmark List.....	244

# Introduction

The Engineering & Design Standards Manual provides the technical design requirements and guidelines for Design Professionals preparing plans for private development or capital improvement projects. The chapters herein include water, wastewater, reclaimed water, storm drainage, streets, traffic signals, streetlights, traffic barricades, landscaping (City owned R.O.W., medians and retention basins), and survey control.

This manual is consistent with Codes and Policies adopted by City Council and referenced in City Code Chapter 43-4 – Adoption of public works standards, specifications, and regulations.

The City Engineer reserves the right to modify the requirements of this manual when necessary in the public interest.

## Disclaimer

The City of Chandler is not responsible for the use of all or any portion of this document by any other public agency or private entity. No representation or warranty of any kind is made concerning the accuracy, completeness, suitability, or utility of any information or product referenced in this document, and the City assumes no liability arising from such use. Further, the City's role in reviewing and permitting projects is limited to verifying general conformance to City requirements. The City does not assume liability for unsuitable design or improper construction. Review and acceptance does not absolve the owner, developer, engineer, or contractor of liability.

## **Standard Specifications and Details**

Plans and construction documents will utilize Maricopa Association of Governments (MAG) ***Uniform Standard Specifications and Details for Public Works Construction (MAG Specifications and Details)*** and the ***City of Chandler Standard Details and Specifications (City Supplements)*** for identifying the work. City Supplements to MAG Specifications and Details are various; please refer to the individual Sections, as modified.

'**MAG Section**' and '**MAG Detail**' throughout this manual means the MAG Specifications and Details, and '**Specification**', '**City Detail**', and '**Fire Department Detail**' refers to the City Supplements.

The latest version of the construction notes (General, Water, Sewer, Reclaimed, Grading and Drainage, Paving, Street Light, and Signing and Striping) must be incorporated into the construction plans as applicable to the type of construction.

In addition to these standards, developers are responsible for following all other applicable federal, state, and local regulations. Where there is a conflict between these standards and

other codes or regulations, the more stringent standard shall generally apply unless otherwise approved by the City Engineer.

(Intentionally left blank)

## Chapter 1 - Water System Design

### 1.1 **GENERAL INFORMATION**

Please refer to City Code Chapter 47-1 - Definitions for Off-Site Improvements and to City Code Chapter 47 - Off-Site Construction Improvement Requirements for Property Development for City Code requirements. Refer to the City of Chandler *Water, Wastewater, and Reclaimed Water Master Plan* for additional policy and planning issues.

All pipe trenches must contain locator wire and identification tape in accordance with MAG Detail 399-1. All pipe backfill must be half-sack CLSM in accordance with MAG Section 728 unless ABC or native material is pre-approved during plan review. Paved surface replacement must be in accordance with MAG Detail 200, T-Top.

#### 1.1.1 **Potable Water**

Please refer to City Code Chapter 52 - Water Services for City Code requirements.

Water lines are required adjacent to all public streets. Water lines must border each development to be served with municipal water. Developers must install water lines, service lines, valves, fittings, and appurtenances within and adjacent to developments and as determined by the City Engineer. Stub-outs for future services must be constructed.

A water system infrastructure analysis is required for proposed developments determined by the City Engineer to have a large impact on the water system. The developer of the property will be responsible for the costs associated with the infrastructure analysis.

Under special conditions the City may accept a public water line on private property. All of the following conditions must be met:

The water line must be fully integrated with the public water system and the water line must be tied into the public system at each end.

- a. The water line must be in a dedicated easement.
- b. The water line must meet City construction standards.
- c. The City Engineer must determine that acceptance of the water line benefits the City.
- d. Pipe must be ductile iron pipe per AWWA C151, pressure class 350.

Per City Code, all water lines 4 inches in diameter and larger are subject to all of the requirements listed in this chapter and are not governed by the *International Plumbing Code*. All private water lines less than 4 inches in diameter are governed by the *International Plumbing Code*.

The requirements given in the *International Plumbing Code* apply to all situations not specifically covered by this chapter.



### 1.1.2 Definitions

Appurtenance: means item attached to a main structure to enable it to function, but not considered an integral part of it.

Air-gap Separation: means the unobstructed vertical distance through the free atmosphere between the lowest opening from any pipe or faucet supplying water to a tank, plumbing fixture, or other device and the flood level rim of the vessel. An approved air-gap must be at least double the diameter of the supply pipe, measured vertically, above the top of the overflow rim of the vessel, and in no case less than 1-inch.

Atmospheric Vacuum Breaker (also known as "nonpressure type vacuum breaker": means an assembly containing a float check, a check seat, and an air inlet port. The flow of water into the body causes the float to close the air inlet port. When the flow of water stops, the float falls and forms a check valve against backsiphonage and at the same time opens the inlet port to allow air to enter and satisfy the vacuum. A shutoff valve immediately upstream may be an integral part of the assembly. An atmospheric vacuum breaker is designed to protect against a health hazard (i.e. contaminant) under a backsiphonage condition only.

Auxiliary Water Supply: means any water supply on or available to the premises other than the City's approved public potable water supply. These auxiliary waters may include water from another purveyor's public potable water supply or any source(s) such as well, spring, river, stream, treated effluent, wastewaters, etc., or "used waters" or "industrial fluids." These waters may be polluted or contaminated or they may be objectionable and constitute an unacceptable water source over which the City does not have sanitary control.

Backflow Prevention Assembly: means a double-check valve assembly, reduced pressure principal assembly, or an air-gap separation that meets the requirements of *Arizona Administration Code R18-4-215* and is approved by the Building Official of the City.

Building Drain: means the main sewer system underneath a building.

Building Sewer: means the part of the sewer system that extends from the end of the building drain and conveys to the service tap.

Contamination: means an impairment of the quality of the potable water by sewage, industrial fluids, waste liquids, compounds or other materials to a degree which creates an actual or potential hazard to the public health.

Cross-connection: means any physical connection or arrangement of piping or fixtures between two otherwise separate piping systems, one of which contains potable water and the other non-potable water or industrial fluids of questionable safety, through which or because of which backflow may occur into the potable water system. A water service connection between a public potable water distribution system and a customer's water distribution system which is cross-connected to a contaminated fixture, industrial fluid system or with a potentially contaminated supply or auxiliary water system, constitutes one

type of cross-connection. Other types of cross-connections include connectors such as swing connections, removable sections, four-way plug valves, spools, dummy sections of pipe, swivel or change-over devices, sliding multi-port tube, solid connections, etc.

Developer: means any person(s), corporation, partnership, or firm desiring municipal water, sewer, or reclaimed water service.

Device Service Line: means a pipe carrying water from the public water line to a water meter or other point of distribution.

Distribution System: means the network of public water lines 16 inches in diameter and smaller which compose the basic grid and distribution system for water service.

Double Check-detector Check Valve Assembly: means a specially designed assembly composed of a line-size approved double check valve assembly with a specific bypass 5/8-inch by 3/4-inch, or 3/4-inch water meter and a 3/4-inch approved double check valve assembly. The meter must register all rates of flow. This assembly must only be used to protect against a non-health hazard (i.e. pollutant).

Effluent: means effluent which has been treated to achieve a quality suitable for a subsequent use as prescribed by Federal and State regulations.

FDC (Fire Department Connection): means a Siamese-headed swivel connection for fire hoses for the purpose of pressurizing building sprinkler lines.

Fire Line: means a private water line located on private property which is utilized exclusively for providing water to fixed fire protection systems.

Hazard, Degree of: means the term is derived from an evaluation of the potential risk to public health and the adverse effect of the hazard upon the potable water system.

- a. *Hazard, health*: Any condition, device or practice in the water supply system and its operation which could create or in the judgment of the City may create a danger to the health and well-being of the water consumer. An example of a health hazard is a structural defect, including cross-connections, in a water system.
- b. *Hazard, plumbing*: A plumbing type cross-connection in a consumer's potable water system that has not been properly protected by a vacuum breaker, air-gap separation or backflow prevention device. Unprotected plumbing type cross-connections are considered to be a health hazard.
- c. *Hazard, pollutant*: An actual or potential threat to the physical properties of the water system or to the potability of the public or the consumer's potable water system but which would constitute a nuisance or be aesthetically objectionable or could cause damage to the system or its appurtenances, but would not be dangerous to health.

- d. *Hazard, system:* An actual or potential threat of damage to the physical properties of the public potable water system or the consumer's potable water system or of a pollution or contamination which would have an effect on the quality of the potable water in the system.

Industrial Fluids System: means any system containing a fluid or solution which may be chemically, biologically, or otherwise contaminated or polluted in a form or concentration such as would constitute a health, system, pollutant, or plumbing hazard if introduced into an approved water supply. This may include, but not be limited to: polluted or contaminated waters; all types of process waters and "used waters" originating from the public potable water system which may have deteriorated in sanitary quality; chemicals in fluid form, plating acids and alkalies, circulated cooling waters connected to an open cooling tower and/or cooling towers that are chemically or biologically treated or stabilized with toxic substances; contaminated natural waters such as from wells, springs, streams, rivers, urban lakes, irrigation canals or systems, etc., oils, gases, glycerine, paraffins, caustic and acid solutions and other liquid and gaseous fluids used in industrial or other purposes or for fire-fighting purposes.

Interceptor, Trunk, or Main Sewer: means a sewer line 18 inches and larger in diameter and tributary to an outfall sewer. It collects sewage from one or more laterals.

Lateral or Submain Sewer: means a sewer line equal to or less than 15 inches in diameter and tributary to an interceptor or larger sewer. It collects sewage from two or more service taps.

Municipal Sewer Service: means sanitary sewer service provided for domestic, commercial, and industrial purposes.

Municipal Water Service: means water service provided for domestic, commercial, recreational, and landscaping purposes.

Outfall Sewer: means the sewer line that conveys the sewage from interceptors to the final point of discharge or treatment.

PIV (Post Indicator Valve): means an above-ground assembly to indicate the position of the gate for an underground water valve.

Pollution: means the presence of any foreign substance (organic, inorganic or biological) in water which tends to degrade its quality so as to constitute a hazard or impair the usefulness or quality of the water to a degree which does not create an actual hazard to the public health but which does adversely and unreasonably affect such waters for domestic use.

Pressure Vacuum Breaker Assembly: means an assembly containing an independently operating, loaded check valve and an independently operating, loaded air inlet valve located

on the discharge side of the check valve. The assembly must be equipped with properly located test cocks and tightly closing shutoff valves located at each end of the assembly.

Private Sewer Line: means any sewer line not owned and maintained by the City.

Private Water Line: means any potable or reclaimed water line not owned and maintained by the City.

Public Sewer Line: means a sewer line owned and maintained by the City.

Public Water Line or Public Water Main: means a potable or reclaimed water line owned and maintained by the City.

Reclaimed Water: means wastewater that has completed the stages of treatment at a wastewater treatment plant.

Reclaimed Water Service: means City service to provide reclaimed water for commercial, recreational and landscaping purposes.

Reclaimed Water System (Public): means the reclaimed water system upstream of the outlet of the reclaimed water meter or turn-out structure.

Reclaimed Water System (Private): means the reclaimed water system downstream of the reclaimed water meter unless otherwise determined by the City Engineer.

Reclaimed Water User: means the private entity that executes the City's Reclaimed Water Use Agreement and who is the applicant for ADEQ Type 2 or Type 3 Reclaimed Water General Permit or a private entity that received reclaimed water from another reclaimed water purveyor; or a reclaimed user that lies within the alternate reclaimed water purveyor service area and is located North of Germann Road.

Reduced Pressure Principle Backflow Prevention Assembly: means an assembly incorporating two independently acting check valves together with an automatic hydraulically operating, mechanically independent pressure differential relief valve located between the two check valves along with tightly closing shut-off valves located at each end of the assembly, and the necessary appurtenances for testing. The device must operate to prevent backflow through the device by closing of the check valves and maintaining the pressure in the zone between the two check valves less than the pressure on the potable public water supply side of the device.

Sampling Location(s): means as part of the City's Wastewater Pretreatment Program, Public Works & Utilities Department will determine if a sampling location(s) is required through *Wastewater Questionnaire* process. The location(s) of the sampling point, if necessary, will be determined by the Public Works & Utilities Department with concurrence from the City Engineer.

Service Tap: means that part of the sewer collection system constructed with the City right-of-way that provides a connection between the building sewer and the lateral sewer. Also known as "Building Sewer Connection" (see MAG Detail 440).

Sewer Service Area: means a designated area from which sewage flows originate or contribute to the sewer system.

Transmission Main: means a public water line larger than 16 inches in diameter.

Water, Potable: means any water which, according to recognized standards, is safe for human consumption.

Water, Non-potable: means water which is not safe for human consumption or which is of questionable potability.

Water Service Connections: means the terminal end of a service connection from the public potable water system, i.e., where the City loses jurisdiction and sanitary control over the water at its point of delivery to the customer's water system. If a meter is installed at the end of the service connection, then the service connection will mean the downstream end of the meter. There should be no unprotected takeoffs from the service line ahead of any meter or backflow prevention device located at the point of delivery to the customer's water system. Service connection must also include water service connection from a fire hydrant and all other temporary or emergency water service connections from the public potable water system. However, except in the case where residential homes incorporate the use of reclaimed wastewater as a water conservation measure, the service connection must be at the pipe union located beyond the approved backflow prevention device. There must be no connections made upstream of the pipe union. The City system will include all piping between the water meter and the pipe union, including the backflow prevention device.

Water, Used: means any water supplied by the City from a public potable water system to a consumer's water system after it has passed through the point of delivery and is no longer under the sanitary control of the City.

Wastewater Meter: means a wastewater meter is required when there are auxiliary water sources that may contribute to sewer flows from a development.

### **1.1.3 Standard Specifications and Details**

City Supplements to MAG Details include the Water Series (C-3XX), the Wastewater Series (C-4XX), and the Fire Department Series (XXX) Standard Details. City Supplements to MAG Specifications are various; please refer to the individual Sections, as modified.

The latest version of the construction General Notes, Water Notes, Sewer Notes, and/or Reclaimed Water Notes must be incorporated into the construction plans as applicable to the type of construction.

Existing asbestos-concrete pipe to be abandoned may be abandoned in place or removed according to the on a case-by-case determination of the City Engineer. Contact the City's Environmental Management Division for specifications to be included in construction documents and staff for construction requirements.

## **1.2 POTABLE WATER DISTRIBUTION AND TRANSMISSION SYSTEM**

### **1.2.1 Water Main Requirements**

#### **1.2.1.1 *Jurisdictional Agency Approval***

Water systems must be designed and constructed in accordance with the following regulations.

- a. Maricopa County Health Code
- b. Arizona Administrative Code (AAC) Title 18, Chapter 5, Article 5 (Minimum Design Criteria)
- c. Arizona Administrative Code Title 18, Chapter 4, Article 2 (Backflow Protection)

These are not all-inclusive and the Design Professional should adhere to all other applicable, City, county, state, Maricopa Association of Governments (MAG), and federal regulations.

Plans must bear the approval signature of the Maricopa County Environmental Services Department (MCESD) prior to approval by the City. Requests for letters of Approval to Construct will be routed to the City Engineer through Civil Plan Review. The Developer/Design Professional that has applied for the Approval to Construct is also responsible to submit the Approval of Construction and obtain final sign off through MCESD before the City will accept the infrastructure improvements.

Refer to the AAC, MAG Section 610.5, and MAG Detail 404 for separation requirements for protection against possible contamination. Drainage pipe for areas that receive reclaimed water irrigation and reclaimed water lines will be considered equivalent to a sanitary sewer for determining separation distances next to water lines. Where protection of the waterline is required, ductile iron pipe must be utilized.

Refer to City Code Chapter 52- Water Services for City requirements regarding water service. The City Engineer may require an engineering analysis for developments to establish water system requirements.

The *Wastewater Discharge Questionnaire* which characterizes the waste flows generated from the new potable water connection must be submitted with non-residential building permit applications.

If water service is being provided to developments/sites that do or will house, generate, or potential discharge from Industrial fluids system, a detailed water quality study for wastewater discharges will be required before the water connection is approved. This may include, but not be limited to:



- a. Polluted or contaminated waters;
- b. All types of process waters and "used waters" originating from the public potable water system which may have deteriorated in sanitary quality;
- c. Chemicals in fluid form, plating acids and alkalies, circulated cooling waters connected to an open cooling tower and/or cooling towers that are chemically or biologically treated or stabilized with toxic substances;
- d. Contaminated natural waters such as from wells, springs, streams, rivers, urban lakes, irrigation canals or systems, etc.;
- e. Oils, gases, glycerine, paraffins, caustic and acid solutions; and
- f. Other liquid and gaseous fluids used in industrial purposes.

#### **1.2.1.2 Engineering Requirements**

The following engineering requirements apply to all public waterline extensions:

- a. The developer causing extension of a waterline must locate it in City rights-of-way or easements and must pay in full the engineering, construction and inspection costs of the lines and appurtenances.
- b. Plans and specifications must be prepared in accordance with appropriate standards as established by the City Engineer.
- c. Each lot or parcel of land to be served with municipal or industrial water must abut a water main.
- d. All lines must be sized in accordance with the latest water master plan, except that the City Engineer reserves the right to increase or decrease the diameter of any and all mains described in the plan when requirements so dictate.
- e. In all new developments, such as subdivisions, multifamily tracts, commercial centers, shopping centers, industrial or other similar developments, the developer must furnish and install, to City specifications, all water mains, service connections, valves, fittings, fire hydrants and appurtenances within the boundary of the development as well as the streets bounding the tracts, and make waterline extensions as determined necessary by the City Engineer.
- f. The engineering requirements set forth herein are intended to supplement rather than supersede other applicable local county, state and federal requirements and, in the case of conflict, the more stringent requirement will apply.

The Developer/Design Professional is responsible to obtain Approval of plans, permits, inspections and acceptance.

- a. All other Jurisdictional Authority requirements must be met and the Developer/Design Professional is responsible to submit proof of their acceptance.
- b. The City will acquire ownership of all extensions of public mains when completed, approved and accepted. The system must be conveyed to the City free and clear of all clouds to title, including liens and encumbrances.

- c. Permanent-type, certified, reproducible as-built record plans must be filed with the City Engineer upon completion of construction of additions to the system. The mylar executed by the City and other Jurisdictional Agencies is critical to the final acceptance process, the Developer/Design Professional is responsible to complete all required signature blocks and the associated paperwork. Submission of the fully executed project mylar is a requirement for acceptance of the infrastructure by the City.
- d. Acceptance of all extensions requires the written approval of the City Engineer and will be dependent on all inspections, test results and the above noted requirements being met.

#### **1.2.1.3 Easement Requirements**

All public water lines must be placed in either the public right-of-way or within a dedicated easement. The minimum easement width is 16 feet, with the entire easement free of property lines, boundary walls, and other obstructions for its entire length and width. Joint water and sewer line easements must be 24 feet wide, with eight feet of separation between the lines.

Water lines, service lines, and fire lines are not allowed in retention basins.

#### **1.2.1.4 Acceptable Pipe Materials and Construction Requirements**

Refer to the current *List of Approved Products* for acceptable pipe materials. Ductile iron pipe must be utilized throughout the extents of vertical water main re-alignments (dipped sections) plus full pipe lengths on each side of the dipped section. Ductile iron pipe must be utilized where waterline protection is required in accordance with MAG Detail 404.

Waterlines must be constructed in accordance with MAG Section 610. Bedding must conform to City Detail C-308. All pipe trenches must contain locator wire and identification tape in accordance with MAG Detail 399-1.

All pipe fittings must be ductile iron pipe in accordance with MAG Section 750.

All underground fire lines must be ductile iron pipe within 10 feet of double check detector, buried swing check, post indicator valve, fire department connection and the building, including vertical and above grade piping. The remainder of the lines may be PVC C900 or C905.

All 4" and larger waterlines must be pressure tested and disinfected in accordance with MAG Section 611. Developer is responsible for pressure testing (witnessed by City Inspector) and disinfecting private waterlines.

#### **1.2.1.5 Joint Restraining**

Joint restraints are required in all connections except for flange-to-flange fittings.

Restrained joints must be push-on for piping or mechanical joint fittings with wedge-type mechanical pipe-grippers. Restrained joint pipe must be applied the entire length of pipe ( $L_R$ ) as shown within the Construction Drawings.

No field cuts of restrained pipe are permitted without prior approval of the Construction Manager.

Joint assembly must be in strict conformance with AWWA C600 and manufacturer's recommendations.

Restrained joints for fittings must be mechanical joint fittings with wedge-type mechanical pipe-grippers or flange. The wedges must be ductile iron heat treated to a minimum hardness of 370 BHN. The mechanical joint restraint must have a working pressure of 350 psi.

Refer to the current *List of Approved Products* for products that meet City requirements.

#### **1.2.1.6 Backflow Prevention**

##### **A. General**

The potable water system must be protected from contamination caused by backflow through unprotected cross-connections. All engineering designs must conform to Arizona Administrative Code, Title 18, Chapter 9, Article 1, R18-4-215 "Backflow Prevention" and City of Chandler Municipal Code Chapter 52, Article IV "Backflow and Cross-connection Control Program".

##### **B. Approved Backflow Assemblies**

Backflow prevention assemblies must conform to the current list issued by the Foundation for Cross Connection Control and Hydraulic Research (FCC&HR), University of California and/or the American Society of Safety Engineers and be UL listed or Fire Marshal approved for fire protection use when used for fire protection systems. Backflow assemblies must be installed in accordance to the FCC&HR.

##### **C. Non-Residential and Multi-Family Backflow Assembly Requirements**

Reduced pressure assemblies (City Details C-311 and C-315) must be installed on all non-residential and Multi-Family potable water services. Double-check valves may be used for dedicated fire sprinkler services without chemical additives (Fire Department Details FD102 and FD103).

For potable water service lines 3 inches in diameter and under, each backflow prevention assembly must be located on private property within 6 inches of the potable water meter. For potable water service lines greater than 3 inches, each backflow prevention assembly must be located on private property and as close as practical to the potable water meter. Upon request, the City Engineer may permit the service line to be encased in a PVC sleeve if this is not practicable.

#### **D. Residential Assembly**

Reduced pressure principal assemblies (City Detail C-311) must be installed on residential potable water service within 6 inches of the meter when one or more of the following conditions exist:

- a. Reclaimed water will be used on the residential property.
- b. Reclaimed water service is or will be available for use on the residential property. (note: if a reclaimed water line is designed solely to transmit reclaimed water across the residential property a backflow assembly will not be required.)
- c. Well water from a well is available for use on the residential property
- d. A cross-connection with a non-potable water source has been identified.

Upon request, the City Engineer may permit the service line to be encased in a DIP sleeve if this is not practicable to install the backflow assembly within 6 inches of the meter.

#### **1.2.1.7 Construction Plan Requirements**

##### **A. Plans (General)**

All plans must be prepared and signed by a registered professional engineer.

Plans must be submitted on 24" x 36" sheets. The plans must be drawn to an engineering scale with 1" = 20' and 1" = 40' being the preferred horizontal scales. The vertical scale, when profile is required, need not differ from the horizontal scale by a precise factor of 10. Water, sewer, and paving plans may all be shown on the same plan sheets if a horizontal scale no smaller than 1" = 20' is used.

All water lines and transmission mains 12 inches or larger in diameter must be shown in both plan and profile views. 12-inch diameter water lines must be shown in both plan and profile views whenever existing utilities are likely to be encountered. All dip sections must be shown in both plan and profile views regardless of the water line size.

The City of Chandler has two policies that should be reviewed: Abandoned Utilities in the City's Right of Way and Private Development Testing Procedures. All utility abandonments within the City's Right of Way will be reviewed on a case by case basis. All proposed abandonments must be shown on a separate plan sheet that documents the demolition of existing utilities. The Developer/Design Professional must confirm that their testing requirements contained within their specifications will meet the City's Private Testing Procedures. Both of these documents are available on the City's Unified Development Manual website.

The engineer must incorporate into the plans the latest copy of the construction *Water Notes*.

Project Vertical datum must be NAVD 88 with equations to legacy City Datum NGVD 29 and any as-built plans that affect the project. The nearest City CMCN benchmark must be utilized for establishing City Datum. See Chapter 9 – Survey and Vertical Control Benchmarks for more information.

## **B. Dipped Sections**

Ductile iron pipe (mechanical joint or restrained) must be installed through all dipped sections, plus full pipe lengths on each side of the dipped section. All dipped sections must be shown in profile view and must include the following items:

- a. Minimum vertical clearance of 2 feet from obstructions.
- b. Encasement per MAG Detail 404, if applicable.
- c. Thrust blocks or joint restraint with standard detail call-out.
- d. Vertical and horizontal location of fittings.

### **1.2.2 Water Transmission System – Additional Design Criteria**

#### **1.2.2.1 General**

Transmission mains are installed under the pavement in the center of a traffic lane unless otherwise directed by the City Engineer. This is graphically shown in City Details C-200 and C-201.

Water services, fire hydrants, and fire lines may not be installed on transmission mains.

Minimum pipe cover must be 48 inches.

#### **1.2.2.2 Valve Requirements**

Valves on transmission mains are required only at the section line and one-half section line points where a bypass valve assembly is required. Valves must be spaced at the one-half mile.

Provisions must be made to tie the transmission main into the distribution system at the section line and the one-half section line points with sufficient valving to completely isolate the transmission main from the distribution system without obstructing the functional characteristics of either the transmission main or the distribution system. A bypass valve assembly is required wherever a transmission main comes to a dead-end.

Valve box installations must conform to City Detail C-307.

Resilient wedge gate valves must be used on all water lines, unless otherwise noted and approved through the plan review process. Refer to City Detail C-320 for the valve vault detail.

City water valves (this includes new valves on the public system that have not been accepted by the City) must be operated by City personnel only.

#### **1.2.2.3 Air/Vacuum Valve Assemblies**

Air and vacuum release assemblies in accordance with City Detail C-319 must be installed at crest changes in pipe grade where there is a possibility of a depth of trapped air greater than one-fifth of the diameter of the line.

## **1.2.3 Public Water Distribution System – Additional Design Criteria**

### **1.2.3.1 System Design Criteria**

#### **A. Minimum Pressure**

The City's public water distribution system delivers a minimum pressure of 45 psi, under Peak Hour Demands, and 25 psi during Maximum Day Demands + Fire Flow. These pressures are applicable Citywide and represent the pressure at the service line connection to the public water system. Onsite domestic and fire protection plumbing systems and associated design reports must use the minimum pressure of 45 psi. Pumps may be required for the purpose of increasing pressure to meet application needs or where internal pressure change in elevation requires an additional boost to meet pressure requirements on higher floors.

#### **B. Design Reports**

New developments and re-developments require a water system analysis (basis of design) report to be submitted with first review civil improvement plan submittal. At a minimum, the report must include the following items and must demonstrate that the proposed water system can provide the estimated demand and is in compliance with the City of Chandler standards and performance requirements:

- a. Introduction: Project location & description including land use information
- b. Existing Water Conditions
- c. Design Criteria and Projected Water Demand – Average Daily, Peak Daily and Peak Hour Demand Flows
- d. Fire Flow Demand
- e. Fire Hydrant Flow Test Report, see requirements below
- f. Report must be signed/sealed

Distribution systems must be designed for peak daily flows combined with required fire flows or peak hourly flow. System pressures in all branches of the network must be a minimum of 20 psi with velocity of less than 10 feet per second for peak daily with fire.

The City requires fire hydrant flow tests to ensure sufficient water supply and calibrate hydraulic models. Testing requirements are as follows:

- Must be performed in proximity to the planned project.
- Must be performed by a private, certified testing company.
- Must be performed on weekdays between 6:00 a.m. and 8:00 a.m.
- Must obtain a minimum residual drop of 5 psi for accuracy purposes.
- Must notify Water Distribution staff 48 hours prior to performing flow test and Water Distribution staff must witness testing.
- Report must be less than one year old.



### **C. Domestic Demand**

Refer to the latest City of Chandler *Water System Master Plan* for appropriate demand and peaking factors.

### **D. Fire Flow Demand**

Fire flows must conform to the requirements of the latest adopted *International Fire Code*.

#### **1.2.3.2 General**

All lines must be sized as a minimum in accordance with the current *Water System Master Plan* and the water line size requirements listed below. Lines must generally be looped. Dead-end lines are permitted only with City Engineer's approval.

A 16-inch diameter water line is required along all section line streets. The City Engineer may require the installation of dual parallel 12-inch diameter water lines instead of the single 16-inch water line when special conditions justify it. Dual parallel 12-inch diameter water lines are normally required adjacent to transmission mains, one on each side, or one tier of lots off of the section line street. Depth of cover must be a minimum of 48 inches.

The standard location for 16-inch and smaller water lines is 1-foot behind the sidewalk, 7 feet behind the back of curb on arterial streets, on the north and east sides of the street. When two water lines are installed adjacent to a street, the standard locations are one on each side of the street with the location determined as above. See City Details C-200, C-201, and C-202.

A 12-inch diameter water line is required at all half-mile section line locations. Depth of cover must be a minimum of 48 inches.

In the case of a phased development, each successive phase must satisfy all of the requirements listed above irrespective of the future phases.

Water lines are required adjacent to half streets when the east or north one-half is being constructed or, when in the opinion of the City Engineer, special conditions justify the construction of the water line.

Water line construction in arterial and collector streets must include 8-inch stub-outs to the right-of-way for the purpose of servicing existing parcels and future development when required by the City Engineer.

An 8-inch diameter water line is required at all one-quarter mile section line locations. Depth of cover must be a minimum of 36 inches.

Eight-inch diameter water lines are generally required in all commercial, industrial, and multi-family residential areas and must be private unless otherwise directed by the City Engineer. Eight-inch dead-end lines may not exceed 650 feet.

All other water lines must be a minimum of 6 inches in diameter. Six-inch dead-end lines may not be longer than 300 feet. Looped 6-inch lines may not exceed 1200 feet. Depth of cover must be a minimum of 36 inches.

Wherever possible, dead-end lines will be extended beyond paved surfaces to avoid pavement cutting at time of future connection and be equipped with a curb stop per City Detail C-300. No blow-off assembly will be located in roadway.

### **1.2.3.3 Extension of a Main**

For all extensions of water lines over eleven months in age, a new valve of like size must be installed in the new line at the point of extension. A 3/4-inch saddle and riser must be installed in the line between the new valve and the first existing valve in the existing system. This line will be flushed and tested by the City and the 3/4-inch nut and riser removed. After the City accepts the new water system, and the new valve and existing valves are turned on, the operating nut must be removed from one of the valves, leaving only one valve operable.

### **1.2.3.4 Fire Hydrant Requirements**

Fire hydrant installations must comply with the following requirements:

- a. See the *List of Approved Products* for fire hydrants that meet City requirements.
- b. 500 feet maximum spacing along local, collector, or private streets.
- c. 1,000 feet maximum spacing along arterial street frontages, staggered 500 feet opposite sides of arterial street.
- d. Fire hydrants must not be installed on transmission mains.
- e. One fire hydrant must be installed at all subdivision entrances.
- f. Fire hydrant installations must conform to City Details C-303, with type (color code) called out, C-305, and Fire Department Detail FD123.
- g. Fire hydrants must be stationed or located with survey data.
- h. Fire hydrant installations at intersections must be per City Detail C-305.
- i. Onsite private hydrant(s) are required if the farthest corner of the structure (equipped with an automatic fire sprinkler system) is farther than 600 feet from an existing hydrant. The 600 feet must be measured along a hose-laying distance without crossing a wall, river rock or other structures. Private on-site hydrants must be installed at 600 foot intervals throughout the development when warranted.
- j. Fire hydrant stub valves must be connected by flange to the service 'tee'.
- k. When an existing public fire hydrant is required to be relocated, a new hydrant is required and the existing one must be returned to the City.

The City Engineer and the Fire Marshal reserve the right to modify the spacing requirements listed above.

Hydrants out-of-service must have collars with "out-of-service" signs until the hydrant is put into service. The signs must comply with City Detail C-303-3 and must remain on the fire

hydrants until the water lines are tested, approved, and pressurized. The signs must be reinstalled at any time any fire hydrants are taken out of service, regardless of reason or the amount of time the fire hydrants are expected to be out of service, and dispatch must be notified at 480-782-4130. Only off-site personnel must remove a sign.

Any development that has a water service that is supplied by only two 6-inch water lines: must have a maximum of six hydrants. One fire hydrant must be installed at each subdivision entrance.

If a model home area is to be part of a development, then a fire hydrant must be provided at or near the site entrance. The hydrant must be located within 75 feet of the access roadway and within 300 feet of the property line of the most remote lot to be built upon. The hydrant must be connected to an approved water source. If the distance to the water source is more than 400 feet, the system must be looped to an additional source.

All cul-de-sac dead-end lines must have a fire hydrant installed at the end of line. The fire hydrant must be located 6 feet from the back of curb and the valve must be located in the pavement 1-foot from the lip of the gutter. Dead-end public water mains must not exceed 650 feet.

When an existing fire hydrant must be relocated, a new hydrant must be installed.

#### **1.2.3.5 Valve Requirements**

Valve installations must comply with the following requirements:

- a. Spacing no greater than 600 feet for pipe runs greater than 800'.
- b. Public distribution line, three valves on each tee (other than service tees) and four valves on each cross.
- c. Valve box installations must conform to City Details C-307, and C-317 in areas not subject to wheel loads. These details must be specified in the construction notes on the plan. MAG Detail 270 frame and covers are not permitted. The grade of a valve box and cover located outside of a paved area must be 1/2 inches above sidewalk or adjacent grade.
- d. In subdivisions, valves at intersections must be located at the first lot line away from the intersection and must be stationed. If no lot line exists, valve is to be located minimum of 6 feet from curb return.
- e. In subdivisions, valves at tee intersections must be located laterally along the top of the tee to the first lot line clear of the intersection to avoid conflict with sidewalk ramps and must be stationed. Valves on the leg of the tee must be located per item 4 above.
- f. Refer to valve blocking per MAG Detail 301.
- g. No valve will be located in sidewalk, curb, or ramp areas. Exceptions require a approval from the City Engineer.

- h. Valve locations must be stationed on subdivision plans, and otherwise located on all other plans.

City water valves (this includes new valves on the public system that have not been accepted by the City) will be operated by City personnel only.

#### **1.2.3.6 Single Family Residential Water Services and Meter Requirements**

Water services may not be installed on transmission lines unless approved by the City Engineer. Water service lines must be a minimum of 1-inch in diameter and must not be located in driveways, sidewalks, washes, or retention/detention areas.

Residential services must be in accordance with City Detail C-301-1. Each service must be individually connected to the main. Backflow prevention will be required per Section 1.2.1.5. Meter boxes must be oriented to the perpendicular of the street.

Existing service lines may be extended per C-301-1 requirements. Existing services to be abandoned must be turned off at the main.

The City provides and installs water meters. Owner/Contractor must provide all fittings to accept meter. Meter boxes must be located within the right-of-way or within a dedicated easement. Meter certificates with sizing calculations are required during plan review for all water services except tract subdivision projects.

For water main replacement projects, existing 5/8-inch meters will be replaced with new 5/8-1-inch meters, or a like-for-like basis.

#### **1.2.4 Commercial Potable Water Distribution System**

Commercial developments must be served by a metered potable water system separated from the building fire sprinkler lines.

Systems must be looped with connections to the public water system at distant drive entrances.

Private water lines are not allowed within the right-of-way or utility easements.

Multiple meters must be manifolded with one connection to the public main per City Detail C-301-2.

##### **1.2.4.1 Multi-family Fire Sprinkler Connections**

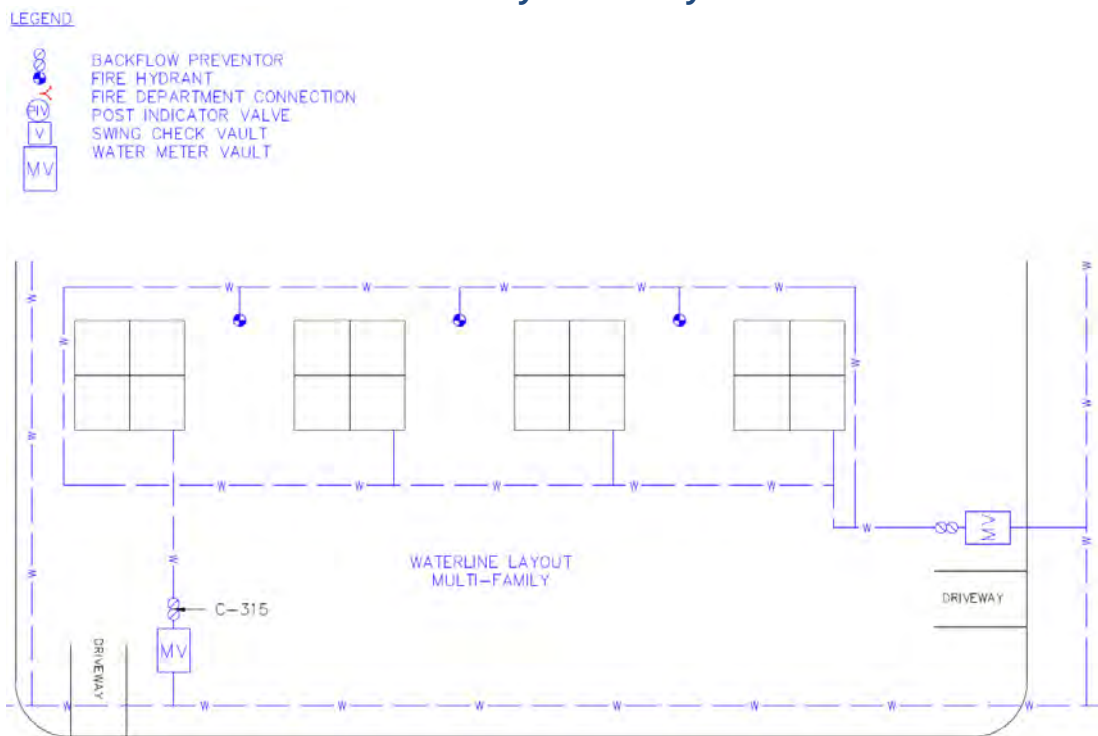
In accordance with Section 28-17 of the City Code, all buildings must be provided with an approved automatic fire sprinkler system. The Fire Department maintains separate standard drawings, plan notes, and plan review guides. Please refer to these standards and the International Fire Code, as adopted and supplemented by City Code, for the design of site improvements.

Multi-family homes (Group R-1 occupancies) must have fire department connections (FDCs) located on the building under the audio/visual (horn/strobe) device for the building. The sprinkler line must be separated from the potable water system with a reduced pressure principal assembly in accordance with City Standard Details.

Multi-family installations may combine the fire sprinkler service with the domestic service. Backflow prevention will be required after the meter, as well as between the sprinkler line and the domestic line. This single line may also supply on site private fire hydrants.

Developments that exceed water line length requirements or include twenty-six (26) or more housing units require a secondary potable water connection, designed, and constructed for full-service redundancy. Each meter should be fed from a separate public main and looped throughout the site, see Figure 1-A.

**Figure 1-A**  
**Multi-Family Fireline Layout**



#### **1.2.4.2 Commercial Meter Requirements**

Commercial service line material per City List of Approved Products. Existing services to be abandoned must be turned off at the main.

The City provides and installs water meters. Owner/Contractor must provide all fittings required to receive the meter assembly. Meter boxes must be located within the right-of-way or within a dedicated easement. Meter certificates with sizing calculations are required during plan review for all water services.

Meter boxes must not be located in driveways and sidewalks.

Individual meter boxes for each building may be ganged within the right-of-way, or a master meter may be provided. Manifolding of meters may only be permitted with the City Engineer's approval, and each meter must have its separate backflow preventer.

#### **1.2.4.3 Commercial Fire Sprinkler and Hydrant Mains**

In accordance with Section 28-17 of the City Code, all buildings must be provided with an approved automatic fire sprinkler system. The Fire Department requires the use of internally-developed standard drawings, plan notes, and plan review guides. Please refer to these standards and the International Fire Code, as adopted and supplemented by City Code, for the design of site improvements.

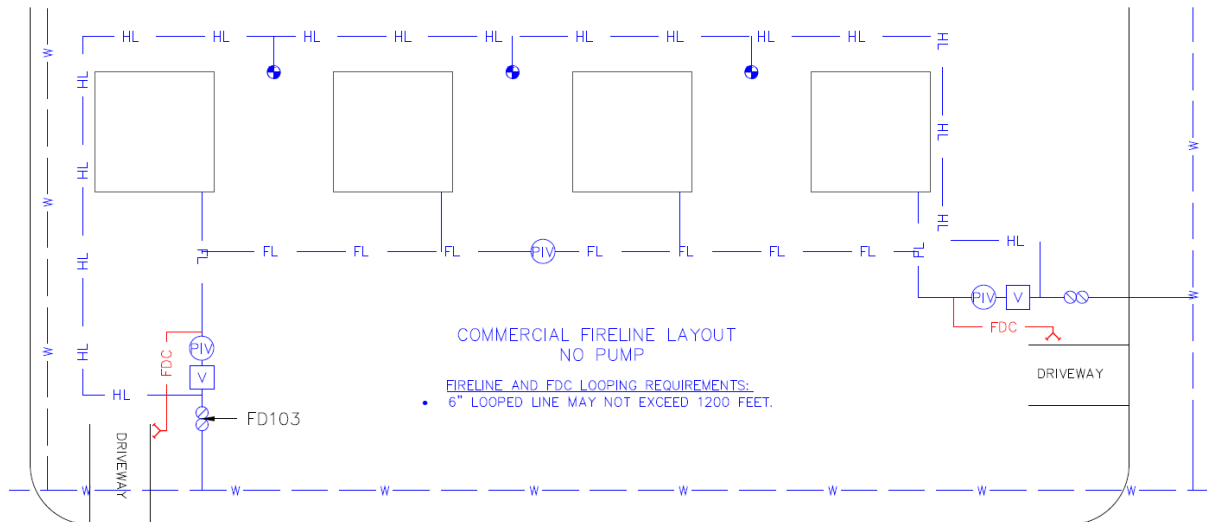
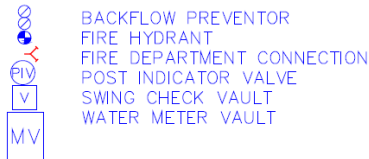
Office/recreation building sprinkler systems must be designed and installed in accordance with NFPA 13. The sprinkler line must be installed in accordance with Fire Department Details FD102 or FD103, with a public fire hydrant located within 150' of the FDC, on the same side of the entrance drive, so that fire hoses would not block the drive. The FDC must be located on private property 6-10 foot behind the curb of the permanent entrance to the site. The FDC must be located on the same street as the sites address. The FDC must be located so that fire apparatus and hose connection to supply the system will not obstruct access to the buildings for other fire apparatus.

A separate fire hydrant supply line, if required by International Fire Code requirements and Section 1.2.3.4, must be looped throughout the site independent of the sprinkler line so that the hydrant line would not be pressurized when a pumper truck is connected to the FDC, see Figure 1-B.



**Figure 1-B**  
**Commercial Fireline Layout without Pumps**

LEGEND



Underground fire lines 8-in diameter must be looped if they exceed 1200 feet. Likewise, 6-in diameter fire lines must be looped if they exceed 600 feet. In no case shall a 6-in looped line exceed 1200 feet.

These dedicated water distribution systems must be separated from the public water system with double check valves per Fire Department standard details unless chemicals are added to the system then a reduced pressure principle valve will be required. See Fire Department Detail FD102 for a dedicated sprinkler system, and Fire Department Detail FD103 for the dual fire hydrant/sprinkler configuration. Fire protection flows are not metered by the City, but for the case of onsite fire hydrants, the double check assemblies must include flow detection meters to monitor for illicit water use. Refer to City List of Approved Products for approved flow detection meters.

All valves on the sprinkler line must be post-indicating (PIV) per the Fire Department detail in Fire Department Details FD102 and FD103. Each building must have a valve close to the point of entry to the building, unless the Fire Department is provided access to a riser control valve within the building. See Fire Department Detail FD105. A minimum of 2 FDC's, located remote from each other, are required for looped underground fire lines supplying multiple risers. Where the sprinkler line is looped for multiple buildings, the sprinkler line must have

at least one PIV at the midpoint for sectional control. PIVs must be labeled in accordance with Fire Department Detail FD104.

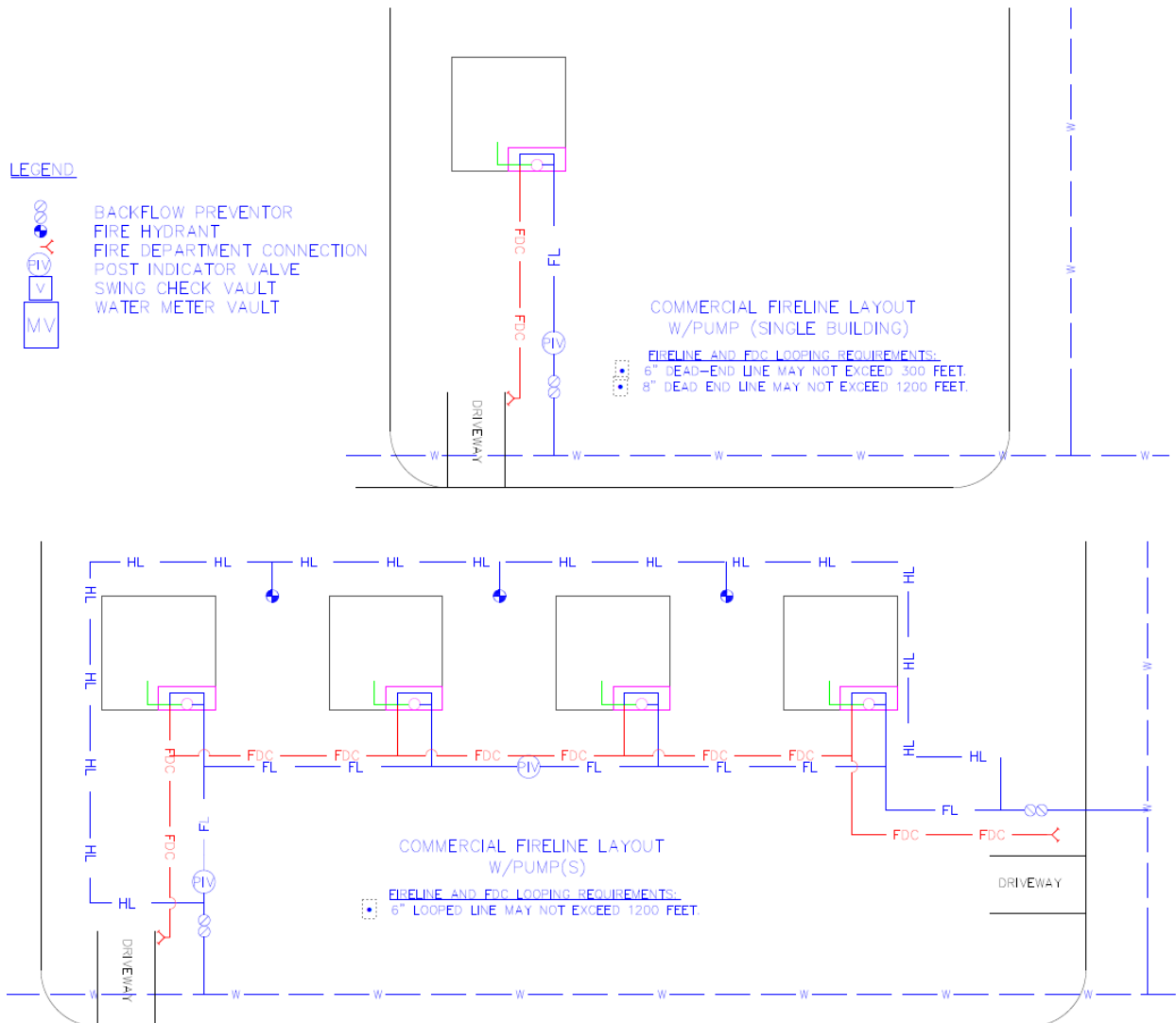
Site fire hydrants must be painted black and yellow. Locking caps on the operating nut are not required. Fire hydrant tees require only one valve, flanged to the tee, unless the fire hydrant installation is also serving as a stub-out. Additional isolation valves are required at approximately 600-foot intervals or when pipe runs longer than 800 feet are encountered. If the Fire Marshal has approved the installation of fire hydrants on the sprinkler line, fire hydrant must be painted brilliant red.

#### **1.2.4.4 Fire Pumps for Industrial Sites**

Chandler does not allow the fire pump to be on the charged riser line. Therefore, if pump(s) are required, a looped FDC line is required in addition to the riser line and the on-site private hydrant line. The riser line should enter each building before the pump(s) and the FDC line needs to be located on the downstream side of the pump. The FDC line then needs to be remoted back out to the entrance of the site, but not connected to the double check. Whether each building has a pump or all building share the same one pump, each building should have a riser line and an FDC line. Since the FDC line is independent of the riser line, the swing check can be omitted and just a double detector check is required, see Figure 1-C.

(Intentionally left blank)

**Figure 1-C**  
**Commercial Fireline Layout with Pumps**



**1.2.4.5 Landscape**

The City offers tiered water rates for landscape service connections. The Design Professional may elect to provide a separate service.

Landscape tracts must be approved with services of a size as determined by a landscape architect and must be shown on the civil plans.

These water systems must be separated from the public water system with a reduced pressure principle assembly per City Detail C-311.

Pipe sleeves are required for service lines extending under roadway pavement within the right-of-way. Sleeves must consist of a ductile iron pipe conduit, 2 nominal diameters larger than the service line for all service lines except for copper service lines which must have PVC sleeves.

The City offers reclaimed water for landscaping water for properties south of Pecos Road. Please refer to Section 4 Reclaimed Water Distribution System below, and the Reclaimed Water Use Agreement.

(Intentionally left blank)

## Chapter 2 - Wastewater and Reclaimed System Design

### 2.1 GENERAL INFORMATION

Please refer to City Code Chapter 47-1 – Definitions for Off-Site Improvements and to City Code Chapter 47 - Off-Site Construction Improvement Requirements for Property Development for City Code requirements. Refer to the *Water, Wastewater, and Reclaimed Water Master Plan* for additional policy and planning issues.

All pipe trenches must contain locator wire and identification tape in accordance with MAG Detail 399-1. All pipe backfill must be half-sack CLSM in accordance with MAG Section 728 unless ABC or native material is pre- approved during plan review. Paved surface replacement must be in accordance with MAG Detail 200, T-Top.

#### 2.1.1 Sanitary Sewer

Please refer to City Code Chapter 51 - Wastewater Services for City Code requirements.

A sewer line must be constructed adjacent to each development to be provided with sewer service. The developer is required to install all of the sewer lines, service taps, manholes, and appurtenances within and adjacent to his development as determined by the City Engineer. Stub-outs for future services must be constructed. All sewer line designs must provide for sufficient capacities and depths to service all of the areas tributary to the development, along with the development itself in accordance with the *City Wastewater Master Plan*.

A sewer system infrastructure analysis is required for proposed developments determined by the City Engineer to have a large impact on the sewer system. The developer of the property is responsible for all costs associated with the infrastructure analysis.

Per City Code, all sewer lines 8 inches in diameter and larger are subject to all of the requirements listed in this chapter. Private sewer lines less than 8 inches are subject to the provisions of the *International Plumbing Code*.

Under special conditions the City may accept a public sewer line on private property. The following conditions must be met:

- a. The sewer line must be in a dedicated easement.
- b. The sewer line must meet City construction standards.
- c. The City Engineer must determine that the acceptance of the sewer line benefits the City.

**2.1.1.1 Reclaimed Water**

Please refer to City Code Chapter 53 - Reclaimed Water Services for City Code requirements.

Reclaimed Water is a valuable resource. Care should be taken in the distribution and use of Reclaimed Water to ensure the public is protected and the resource is used wisely. The City reclaimed water is to be used for commercial, recreational and landscaping purposes. In addition to the design and construction of the Public and Private Reclaimed Water Distribution System, Reclaimed Water Users will be required to complete the Reclaimed Water Service Process prior to the delivery of reclaimed water to a Site/Development.

The source water quality of the City's Reclaimed Water is A+. The Engineer should check with other reclaimed water purveyors for their class of Reclaimed Water.

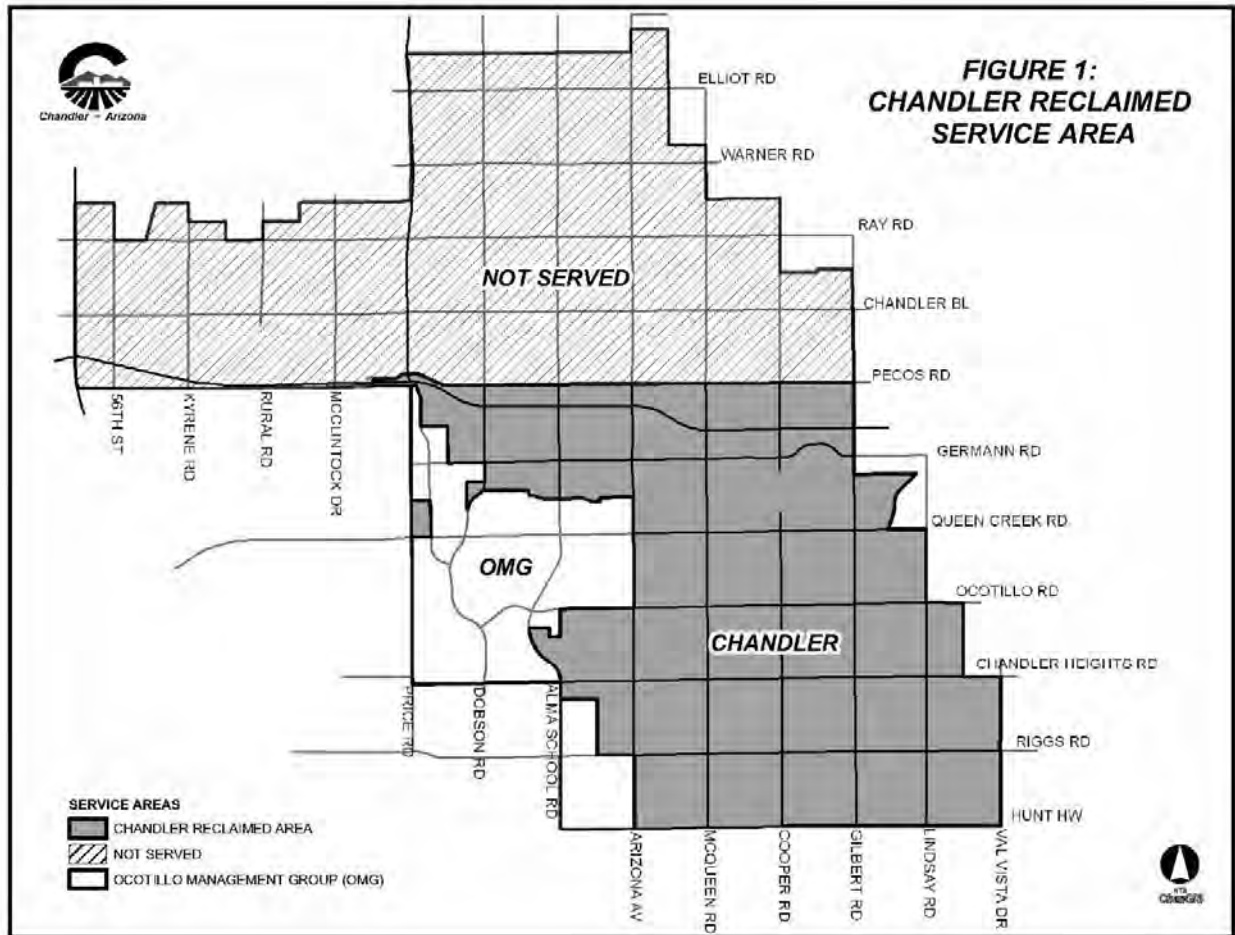
Reclaimed water mains must be constructed by development along the mile and half-mile streets in that portion of the City which is south of Pecos Road and east of Price Road. Please refer to Figure 2-A, Reclaimed Service Area. If reclaimed water is used, a *Reclaimed Water Use Agreement* will be executed between the owner and the City containing conditions pertaining to the service, and a set of approved irrigation plans will be required prior to connection. Stub-outs for future services must be constructed.

Reclaimed water lines 4 inches in diameter and larger will be subject to Engineering approval, lines less than 4 inches will be subject to landscape plan approval.

Within that area west of Arizona Avenue and north of Chandler Heights Road exists, the Ocotillo Management Group which independently delivers reclaimed water. Staff will identify projects within that agency's jurisdiction and provide contact information.

(Intentionally left blank)

**Figure 2-A**  
**Reclaimed Service Area**



### 2.1.2 Definitions

The Definitions in Chapter 1 – Water System Design, Section 1.1.2 also apply to this Chapter 2 – Wastewater and Reclaimed System Design.

### 2.1.3 Standard Specifications and Details

The Standard Specifications and Details in Chapter 1 – Water System Design, Section 1.1.3 also apply to this Chapter 2 – Wastewater and Reclaimed System Design.

## 2.2 WASTEWATER COLLECTION SYSTEM

### 2.2.1 Jurisdictional Agency Approval

All sewer lines must be designed in accordance with the following regulations.

- a. Maricopa County Health Code
- b. Arizona Administrative Code, Title 18, Chapter 9, Article 3, Part E, Type 4 General Permits: §R18-9-E301.401 Sewage Collection Systems



These are not all-inclusive and the Design Professional should adhere to all other applicable, City, county, state, Maricopa Association of Governments (MAG), and federal regulations.

Plans must bear the approval signature of the Maricopa County Environmental Services Department (MCSED) prior to approval by the City. Requests for letters of Approval to Construct will be routed to the City Engineer through Civil Plan Review. The Developer/Design Professional that has applied for the Approval to Construct is also responsible to submit the Approval of Construction and obtain final sign off through MCSED before the City will accept the infrastructure improvements.

Refer to the AAC, MAG Section 610.5, and MAG Detail 404 for separation requirements for protection against possible contamination.

Refer to City Code Chapter 51 Wastewater Services for City requirements regarding wastewater service.

The *Wastewater Questionnaire* which characterizes the waste flows must be submitted with non-residential building permit applications.

The City Engineer may require an engineering analysis for developments to establish wastewater system requirements and confirm City wastewater system capacity. If wastewater service is being provided to developments/sites that do or will house, generate, or potential discharge from Industrial fluids system, a detailed water quality study for wastewater discharges will be required before the water connection is approved. This may include, but not be limited to:

- a. Polluted or contaminated waters;
- b. All types of process waters and "used waters" originating from the public potable water system which may have deteriorated in sanitary quality;
- c. Chemicals in fluid form, plating acids and alkalis, circulated cooling waters connected to an open cooling tower and/or cooling towers that are chemically or biologically treated or stabilized with toxic substances;
- d. Contaminated natural waters such as from wells, springs, streams, rivers, urban lakes, irrigation canals or systems, etc.;
- e. Oils, gases, glycerine, paraffins, caustic and acid solutions; and
- f. Other liquid and gaseous fluids used in industrial purposes.

### **2.2.2 Engineering Requirements**

The following engineering requirements apply to all public waste waterline extensions:

- a. The developer causing an extension of a sewer main must locate it in City rights-of-way or easements and must pay in full the engineering, construction and inspection costs of the lines and appurtenances.
- b. Plans and specifications must be prepared in accordance with appropriate standards established by the City Engineer.

- c. Each lot or parcel of land to be served with sanitary sewer service must abut a sewer main.
- d. All lines must be sized in accordance with the latest wastewater master plan, except that the City Engineer may increase or decrease the size of mains when requirements so dictate.
- e. In all new developments such as subdivisions, multifamily tracts, commercial centers, shopping centers, industrial facilities or other similar developments, the developer must furnish and install, to City specifications, all sewer mains, service connections, manholes, service and main stubs and appurtenances within the boundary of the development as well as the streets abutting the development, and must make sewer line extensions as determined necessary by the City Engineer.
- f. Sewer mains which are not located in public rights-of-way and which do not provide service to other than a single property, will generally not be accepted as a public sewer main. subdivisions, areas to be developed or redeveloped, will be the full responsibility of the developer and in accordance with the sewer master plan;
- g. The engineering requirements set forth herein are intended to supplement rather than supersede other applicable local county, state and federal requirements and, in the case of conflict, the more stringent requirement will apply.

The Developer/Design Professional is responsible to obtain Approval of plans, permits, inspections and acceptance.

- a. All other Jurisdictional Authority requirements must be met and the Developer/Design Professional is responsible to submit proof of their acceptance.
- b. The City will acquire ownership of all extensions of public mains when completed, approved and accepted. The system must be conveyed to the City free and clear of all clouds to title, including liens and encumbrances.
- c. Permanent-type, certified, reproducible as-built record plans must be filed with the City Engineer upon completion of construction of additions to the system. The mylar executed by the City and other Jurisdictional Agencies is critical to the final acceptance process, the Developer/Design Professional is responsible to complete all required signature blocks and the associated paperwork. Submission of the fully executed project mylar is a requirement for acceptance of the infrastructure by the City.
- d. Acceptance of all extensions requires the written approval of the City Engineer and will be dependent on all inspections, test results, and the above noted requirements being met.

### **2.2.3 Easement Requirements**

All sewer lines must be placed in either the public right-of-way or within a dedicated easement. The minimum easement width is 16 feet, with the entire easement free of

property lines, boundary walls, and other obstructions for its entire length and width. Joint water and sewer line easements must be 24 feet wide, with eight feet of separation between the lines.

Sewer lines are not allowed in retention basins unless the City Engineer authorizes the use of a concrete cap over the pipe bedding.

#### **2.2.4 Construction Plan Requirements**

All plans must be prepared and signed by a registered professional engineer.

Plans must be submitted on 24" x 36" sheets. The plans must be drawn to an engineering scale with 1" = 20' and 1" = 40' as the preferred horizontal scales. The vertical scale need not differ from the horizontal scale by a precise factor of 10. Water, sewer and paving plans may all be shown on the same plan sheets, if a horizontal scale no smaller than 1" = 20' is used.

All sewer lines and utility crossings must be shown in both plan and profile views.

Project Vertical datum must be NAVD 88 with equations to legacy City Datum NGVD 29 and any as-built plans that affect the project. The nearest City CMCN benchmark must be utilized for establishing City Datum.

The engineer must incorporate into the plans the latest copy of the construction *Sewer Notes*.

The City of Chandler has two policies that should be reviewed: Abandoned Utilities in the City's Right of Way and Private Development Testing Procedures. All utility abandonments within the City's Right of Way will be reviewed on a case-by-case basis. All proposed abandonments must be shown on a separate plan sheet that documents the demolition of existing utilities. The Developer/Design Professional must confirm that their testing requirements contained within their specifications will meet the City's Private Testing Procedures. Both of these documents are available on the City's Unified Development Manual website.

#### **2.2.5 Design Flows**

New developments and re-developments may require a sewer system analysis (basis of design) report, coordinate with Civil Plan Review to determine if report is required. At a minimum, the report must include the following items and must demonstrate that the proposed sewer system can provide the estimated sewer loads and is in compliance with the City of Chandler standards and performance requirements:

- a. Introduction: Project location & description including land use information
- b. Existing Sewer Conditions
- c. Design Criteria and Projected Sewer Load - Average Daily and Peak Daily Flows (GPD)
- d. Signed/Sealed

All sewer lines must be designed to provide a minimum peak flow velocity of 2.0 feet per second and a maximum velocity of 10.0 feet per second based on full flow and Manning’s equation with a minimum roughness coefficient, "n" factor, of 0.013 for all pipe materials.

The minimum slope requirement for 8-inch diameter sewers from an upper confluence point to the final terminal reaches must be 0.52% to maintain a velocity of 2.5 feet per second based on full flow pipe conditions. The length of 8-inch line at the 0.52% slope must be from that point of confluence to the uppermost service tap.

When sewage flow approximations are necessary the values given in the following tables must be used, unless more accurate information is available. Refer to Arizona Administrative Code R18-9-E301. It is the Design Professional’s responsibility to indicated when more accurate information is available for the proposed site/development and to quantify the difference between these approximations in the following tables. Sites that generate flows that are different than these approximations will require City approval and may result in additional design efforts to satisfy the City.

**Table 2.1**  
**Wastewater Service Factors**

TYPE OF SERVICE	AVERAGE DAILY FLOW (GALLONS/PERSON)	PEAK DAILY FLOW (GALLONS/PERSON)	PEAK FACTOR
Domestic Use	100	300	3.0

TYPE OF SERVICE	AVERAGE DAILY FLOW	UNITS
Theater	5	gallons/seat/day
Retail	1	gallon/square foot/day
Restaurant	30	gallons/day/seat
Hotel/Motel	130	gallons/room/day
Schools (with lunch & shower facilities)	75	gallons/student/day
Schools (without lunch & shower facilities)	50	gallons/student/day
Other	100	gallons/person/day
Industrial & Commercial	1300	gallons/acre/day

**Table 2.2  
Population Factors**

TYPE	NUMBER OF PEOPLE/DWELLINGS
Single Family (SF)	3.3
Patio Homes (PH)	3.1
Multi-Family (MF)	2.8
Mobile Homes (MH)	2.4

Note: The maximum number of dwellings in a square mile section is 3,000.

### 2.2.6 Pipe Materials

Refer to the *List of Approved Materials* for acceptable pipe products. Pipe bedding must conform to City Detail C-402. All pipe trenches must contain locator wire and identification tape in accordance with MAG Detail 399-1.

### 2.2.7 Gravity Sewer Lines

#### 2.2.7.1 General

Owner/Contractor to install a plug at the point(s) of connection to existing lines (outfalls) at the start of construction. Each respective phase must be plugged and remain plugged until accepted by the City. No flows may be released into the City sanitary sewer until all tests have been passed and approved by the City.

All new 8" and larger sewer lines (including stub-outs) must be CLOSED CIRCUIT TV (CCTV) inspected by City CCTV Contractor prior to final acceptance. City pays for the initial inspection in accordance with MAG Section 611. Owner/Contractor may contract directly with City's CCTV Contractor or use their preferred NASSCO certified pipeline assessment contractor for additional CCTV inspection(s).

Sewer lines must be vactored and water added to the system prior to CCTV inspection. Any defects in the pipe, construction methods, or inadequate cleaning must be corrected at no additional cost to the City. Pipe deflections greater than 1-inch will not be allowed.

Sewer lines must be CCTV-inspected prior to end of One-Year Warranty Period. City pays for inspection, and sewer lines are inspected in current active or inactive state.

Pipe installation must be in accordance with MAG Section 615. Pipe bedding must conform to MAG specifications and City Detail C-402. Pipe locator wire and ID tape must be provided in accordance with MAG Detail 399-1.

Curved sewer lines are not allowed without specific City Engineer approval.

### **2.2.7.2 Public Sewer Lines**

Public sewer lines must be a minimum of 8-inches in diameter with a minimum cover of 5 feet.

Sewer lines are required within half streets when the south or west one-half is being constructed, providing that a tributary area exists. The tributary area can either be the development itself or a separate sewer service area that is sewer through the development. To minimize street cuts, every manhole in undeveloped areas must have stub-outs to the edge of the street right-of-way.

Where public utility easements are platted, sewer service connections must be extended eight feet beyond street right-of-way lines to clear all facilities to be installed in public utility easements.

Sewers constructed in arterial streets must be sized in accordance with the Wastewater Master plan. The minimum size for stub-outs at the one-half and one-quarter section lines is 12 inches in diameter. All other stub-outs must be a minimum of 8 inches in diameter and located to serve adjacent properties. On other than arterial streets, minimum size for stub outs must be 4 inches for residential, and 6 inches for commercial uses.

If a model home area is a part of the development project, sewer lines must, as a minimum, be constructed from the point of out fall up to and including the first manhole upstream from the model area.

In the case of phased development, each successive phase must provide sufficient sewers to service all of the areas tributary to the phase.

All public sewer lines must be placed in either the public right-of-way in accordance with City Details C-200, C-201, and C-202 or in a dedicated easement.

Manholes and sewer pipe alignment must be located out of the vehicular wheel paths of arterial and collector streets.

The standard location for sewer lines within the public right-of-way is in the center of a driving lane on the south and west side of the street as shown in the City Supplements. Generally, sewer lines will only be permitted to cross and re-cross the street centerline for short distances, providing that the sewer line maintains a clear distance of 3 feet or more from the lip of gutter on the south and west side of the street. Encroachment of more than 4 feet past the street centerline will generally not be allowed.

### **2.2.7.3 Private Sewer Lines**

Developers of commercial and industrial projects are required to complete a Wastewater Discharge Questionnaire.

Wastewater meters are installed for commercial or industrial projects that consume large quantities of water or have auxiliary water sources that could contribute wastewater flows,

as determined by the City Engineer, thereby reducing or increasing monthly sewer charges. Wastewater meters must be installed in a wastewater monitoring vault in accordance with City Detail C-417.

Private sewer lines are not allowed within the right-of-way or public utility easements. All manholes on private sewers must have covers stamped to read "Private Sanitary Sewer".

In addition, private sewer lines 8 inches in diameter and larger are required to include a plan and profile.

Any construction materials allowed under the *International Plumbing Code* are permitted except High Density Polyethylene Pipe (HDPE).

Cleanouts installed at intervals not to exceed 100 feet are permitted in lieu of the manhole spacing requirements given in this chapter. The cleanout spacing requirements are given in Section 708 of the latest approved version of the *International Plumbing Code*.

Construction of sewer lines is not allowed under retention basins without permission from the City Engineer. Should construction under a retention basin be allowed a concrete cap must be installed over the sewer.

Sewer lines constructed within flood zones or near or adjacent to flood-irrigated areas or retention basins must have water-tight manhole covers as per MAG Detail 423.

### **2.2.8 Force Mains**

Refer to the *List of Approved Products* for acceptable pipe materials.

Sewage pump stations must conform to the requirements of ADEQ Engineering Bulletin No. 11, Chapter IV, C.2 Design Flows for calculating the peaking factors for low volume flows based on population. All sewage pump station wet wells must include approved coatings. Pump stations are not allowed without approval of the City Engineer.

### **2.2.9 Manholes**

A manhole is required wherever the sewer changes pipe material, grade, size, alignment, or intersects another sewer. For new connections, due to high flow pipe conditions, where sewer lines of differing sizes enter the same manhole, the smaller sewer line invert must be at or above the crown of the largest pipe. For connection at existing stub-outs, where the downstream pipe size is 12-inches or smaller, the invert of the stub-out(s) must be at least 0.10 inch above the invert of the downstream pipe. Where the downstream pipe size is larger is 12-inches, using an existing stub-out is at the discretion of the City Engineer.

All manholes must have sewer intersections between 90° and 180° inclusive. Manholes with sewer lines intersecting at angles between 90° and 120° must have a minimum 0.10-foot drop across the manhole. In interceptor and larger sewers, inverts at junctions must be designed to maintain the energy gradient across the junction and to prevent backflow.



All new manholes must be 5-foot diameter with 30-inch diameter covers.

The maximum allowable manhole spacing is 400 feet for sewer lines between 8 inches and 15 inches in diameter. Sewers 18 inches in diameter and greater must have manhole spacing of 600 feet. A cleanout may be installed in lieu of a manhole at the end of a lateral sewer 8 inches in diameter, or less, provided that the distance from the cleanout to the nearest manhole does not exceed 150 feet.

All connections to public sewer manholes and mains must be in accordance with City Detail C-403.

Manhole construction materials must be as follows:

- Manholes serving public sewer mains 15-inch diameter and larger must be composite or polymer concrete materials per City's List of Approved Products.
- "One-off" public manholes (first manhole up-stream of 15-inch diameter and larger sewer mains) must also use composite or polymer concrete materials.
- For sewer mains less than 15-inch, manholes may be installed using standard concrete per MAG Detail 420 with cast-in-place bases.

Composite or polymer concrete manholes must include composite frames and covers, composite adjustment rings, composite or polymer concrete cone and riser sections and cast-in-place bases with approved corrosion protective coating. Refer to City's List of Approved Products, Supplements to MAG Sections 345 and 625, and City Details C-400 and C-401. Composite or polymer concrete manholes and materials used must be as specified on the plans and/or special provisions.

Concrete manholes constructed in arterial streets (for sewer mains less than 15" diameter) must be coated with a corrosion protective coating in accordance with MAG Section 626 and City MAG Supplement Section 626. Coating is only required on the concrete and grouted surfaces. Refer to the City's List of Approved Products for allowable corrosion protective coating systems. Coated surfaces must be Holiday / Spark Tested to verify a continuous, void-free lining system has been installed.

Manholes serving public sewer lines 12-inch and smaller and not within arterial streets must be coated with a latex insecticide paint applied in accordance with the manufacturer's recommendations. Refer to the City's List of Approved Products for allowable insecticide coating products. The coating must be applied in accordance with US Environmental Protection Agency recommendations starting from the top of the manhole to a depth of 8 feet below

### **2.2.10 Service Connections**

Service taps may be connected to the manholes on the sewer line. Service tap inverts must be above the crown of the sewer main. All abandoned sewer service taps must be capped. Service connections 8 inches and larger must be made only at a manhole on the main.

All sewer taps must be the wye type per MAG Detail 440-1 Type 'A' and sized according to the minimum tap size table, below. All connections to existing sewer mains must be accomplished by machine tapping, utilizing a PVC saddle, or by construction of a manhole. Taps on mains 15 inches and larger must be installed directly into a manhole with no more than four taps in a single manhole.

**Table 2.3**  
**Minimum Service Tap Sizes**

TYPE	PIPE SIZE (INCHES)
Residential	4
Multi-Family	6
Industrial	6
Commercial	6

Direct service taps may not be installed on sewers 15-inch and larger. However, a manhole may be constructed on an interceptor or larger sewer, and then a lateral sewer line may be installed. The lateral sewer line extension will terminate upstream in a manhole. Direct service taps then may be installed on the upstream lateral.

All sewer taps should be 4 1/2 feet deep at property line. To raise the tap from the mains deeper than 16 feet, refer to City Detail C-410.

### **2.2.11 Pre-Treatment Requirements**

The City's Wastewater Quality Division will determine if sampling location is required. The location of the sampling point, if necessary, will be determined by the Public Works & Utilities Department with concurrence from the City Engineer.

All industrial projects are required to install an Industrial Monitoring Vault (IMV) per City Detail C-417. Also, other projects that may potentially create industrial type waste are required to install an IMV, unless exempted by the City Engineer. At a minimum, all industrial sites must reserve sufficient space for an IMV and install a manhole with a 6" drop between inverts in lieu of the IMV.

If an IMV is installed, a minimum 4-foot wide easement from the IMV to a point of public access must be dedicated to the City. The City must have 24-hour access to the IMV.

Each IMV with height exceeding 5-feet must be custom designed by the appropriate Design Professional(s).

## **2.3 RECLAIMED WATER DISTRIBUTION SYSTEM**

### **2.3.1 Jurisdictional Agency Approval**

All reclaimed water lines must be designed in accordance with Arizona Administrative Code, Title 18, Chapter 9, Article 6: §R18-9-602 Pipeline Conveyances of Reclaimed Water and the current City Wastewater Master Plan. Plans must bear the approval signature of the Maricopa County Department of Environmental Resources prior to approval by the City. Requests for letters of Approval to Construct will be routed to the City Engineer through Civil Plan Review.

Refer to the AAC, MAG Section 610.5, and MAG Detail 404 for separation requirements for protection against possible contamination.

Refer to City Code Chapter 53 Reclaimed Water Services for City requirements regarding reclaimed water service. Please also refer to the *Reclaimed Water User's Manual* that can be located on the City of Chandler's Unified Development Manual (UDM).

The Reclaimed Water user cannot assume that City's reclaimed water can be used for irrigating farm land or industrial uses. If this is the intent of the Reclaimed Water user please contact the City Engineer prior to commencing plan submittal.

### **2.3.2 Engineering Requirements**

The following engineering requirements apply to all public reclaimed waterline extensions and onsite reclaimed water delivery systems:

- a. The developer causing extension of a reclaimed waterline must locate it in City rights-of-way or easements and must pay in full, less approved City participation as provided above, the engineering, construction and inspection costs of the lines and appurtenances.
- b. Plans and specifications must be prepared in accordance with appropriate standards as established by the City Engineer.
- c. Each lot or parcel of land to be served with reclaimed water must abut a reclaimed water main.
- d. All lines must be sized in accordance with the latest reclaimed water system master plan, except that the City Engineer reserves the right to increase or decrease the diameter of any and all mains described in the plan when requirements so dictate.
- e. In all developments, such as subdivisions, multifamily tracts, commercial centers, shopping centers, golf courses, parks, industrial or other similar developments, the developer must furnish and install, to City specifications, all reclaimed water mains, service connections, valves, fittings, storage structures, turnout structures and appurtenances within the boundary of the development as well as the streets bounding the tracts, and make reclaimed waterline extensions as determined necessary by the City Engineer.

- f. All main line valves must use City Detail C-406 valve box with a square or rectangular frame and cover with the words "Reclaimed Water" in raised letters on the cover.
- g. All reclaimed water distribution systems must be clearly identified in accordance with MAG Section 616. All subsurface piping and fixtures must be installed with purple pipe or by wrapping the pipe with Christy's polyethylene encasement (polywrap) or equal and by marking above ground parts, including valves, valve boxes and covers, controllers, piping, hose bibs, and other outlets purple.
- h. Access to the developers reclaimed water distribution system controller box must be by key.
- i. The engineering requirements set forth herein are intended to supplement rather than supersede other applicable local county, state and federal requirements and, in the case of conflict, the more stringent requirement will apply.
- j. The spray irrigation system must be designed:
  - i. For application between the hours of 10:00 pm to 6:00 am.
  - ii. To prevent ponding of reclaimed water.
  - iii. To prevent direct spray and over spray of from coming into contact with drinking fountains, water coolers, and eating areas.

The Developer/Design Professional is responsible to obtain approval of plans, permits, inspections and acceptance.

- a. All other jurisdictional authority requirements must be met and the Developer/Design Professional is responsible to submit proof of their acceptance.
- b. The City will acquire ownership of all extensions of public mains when completed, approved and accepted. The system must be conveyed to the City free and clear of all clouds to title, including liens and encumbrances.
- c. Permanent-type, certified, reproducible as-built record plans must be filed with the City Engineer upon completion of construction of additions to the system. The mylar executed by the City and other jurisdictional agencies is critical to the final acceptance process, the Developer/Design Professional is responsible to complete all required signature blocks and the associated paperwork. Submission of the fully executed project mylar is a requirement for acceptance of the infrastructure by the City.
- d. Acceptance of all extensions requires the written approval of the City Engineer and will be dependent on all inspections, test results, and the above noted requirements being met.

### **2.3.3 Easement Requirements**

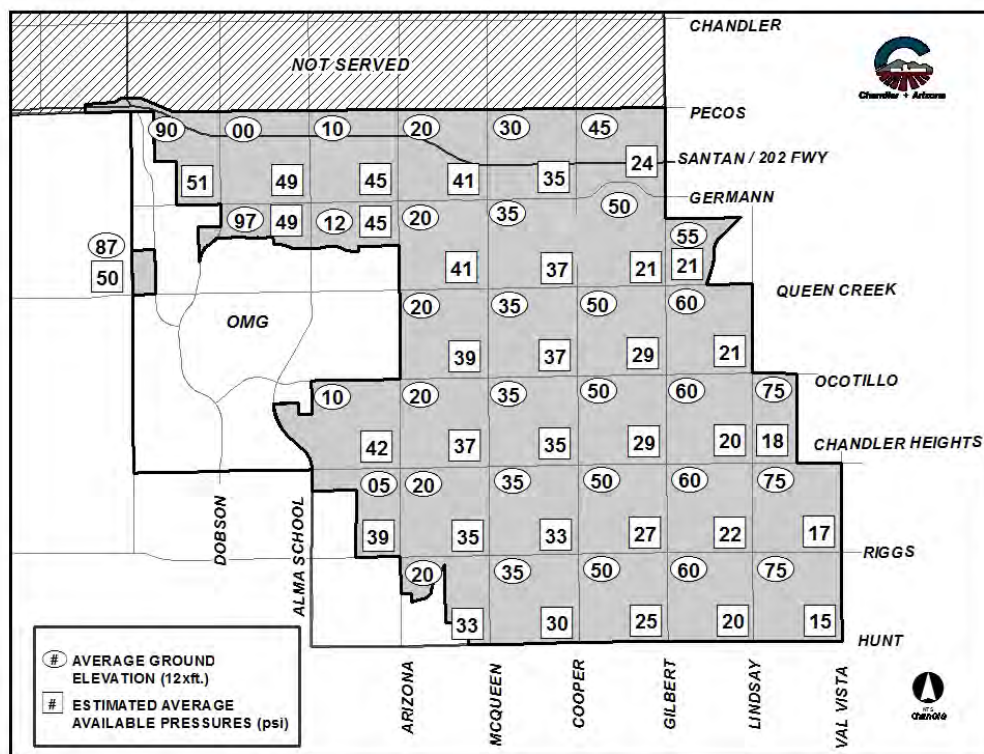
All public reclaimed water lines must be placed in either the public right-of-way or within a dedicated easement. The minimum easement width is 16 feet, with the entire easement free of property lines, boundary walls, and other obstructions for its entire length and width. Joint

reclaimed water and sewer line or joint reclaimed water and water line easements must be 24 feet wide, with 8 feet of separation between the lines.

### 2.3.4 Pressure Considerations

The following figure provides a guide of the estimated available pressures of the reclaimed water distribution system. Pressures could be 10-15 psi lower during high system demand. Reclaimed water pressures immediately upstream of the reclaimed water meter could vary between 20 psi and 60 psi. There may be intermittent pressure drops below 20 psi. The Design Professional should consider the Reclaimed Water system’s pressure fluctuations when designing the onsite distribution system and using a design value of 15 psi lower than what is shown in the figure. The Design Professional is responsible for confirming their design will operate with these system pressure criteria.

**Figure 2-B**  
**System Pressure Criteria**



**2.3.5 Applicable Design Criteria based on Location within Service Area**

The City is not the only purveyor of reclaimed water within the City boundary. There are City delivery agreements with other purveyors and the following should be considered when selecting the design criteria for reclaimed water.

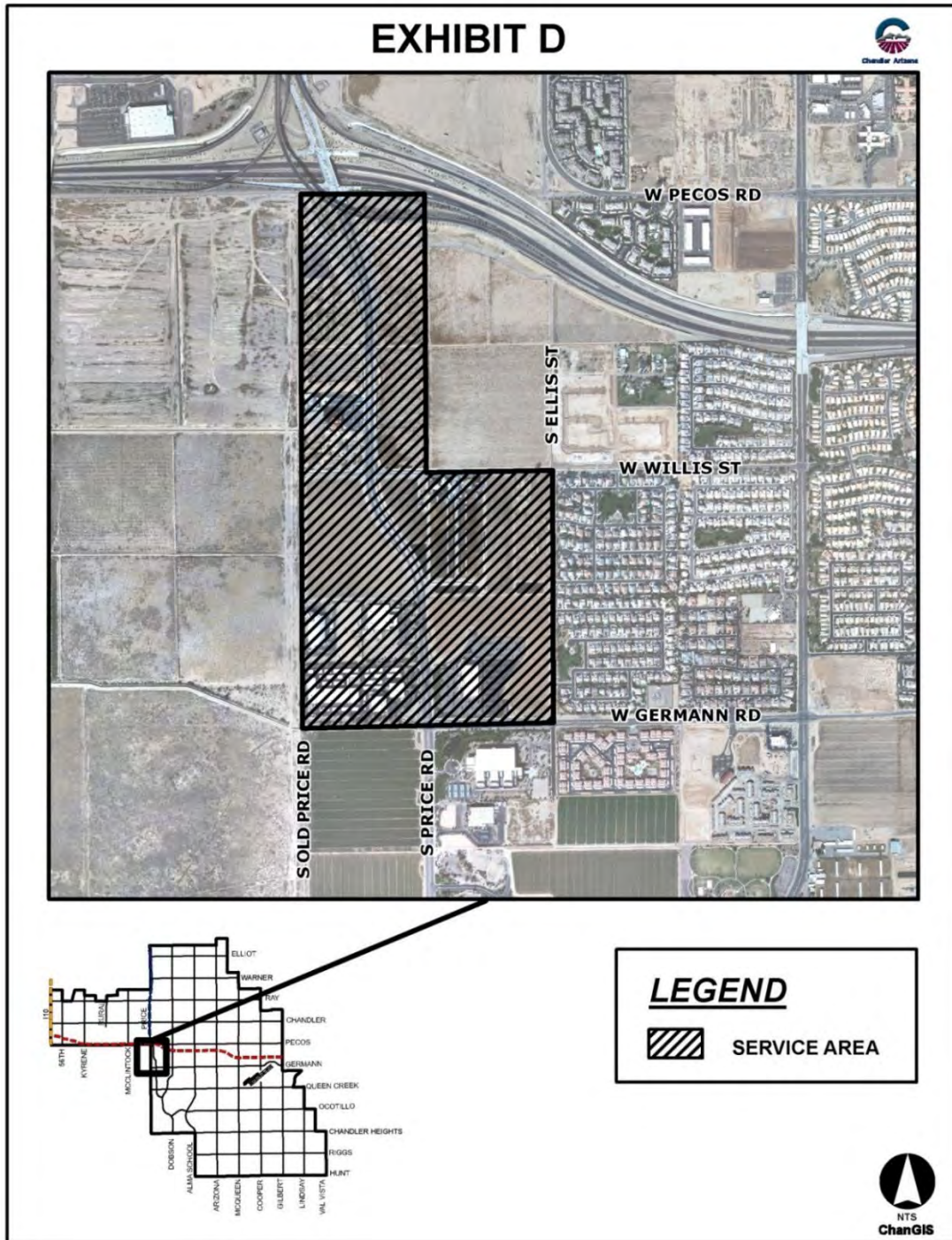
**Table 2.4  
Development Location Design Criteria**

<b>DEVELOPMENT LOCATION</b>	<b>CITY REQUIRED DOCUMENTATION</b>	<b>DESIGN CRITERIA APPROVALS</b>	<b>METER PROVIDER</b>	<b>OWNER TO RECEIVE UTILITY BILL FROM</b>
Within City Service Area	As Noted in this Document	As Noted in this Document	City Reclaimed Water Meter	City of Chandler based on City Utility Rates.
Within Non-City Service Area	Executed Service Agreement with Reclaimed Water Provider	Non-City Reclaimed Water Purveyor Design Standards and Approval is Required. City May Issue Encroachment Permit, if required.	Developer provided to meet the Requirements Non-City Reclaimed Water Purveyor	Non-City Reclaimed Water Purveyor based on the Rate Contracted with the Purveyor
Within Non-City Service but served from City Reclaimed (Public) Water Mains North of Germann Road (see Figure 2-C)	Executed Service Agreement with Reclaimed Water Provider	As Noted in this Document	City Reclaimed Water Meter	Non-City Reclaimed Water Purveyor based on the Rate Contracted with Purveyor

(Intentionally left blank)



**Figure 2-C**  
**Exhibit D Amendment No. 1**  
**(Ocotillo Management Group/Chandler Reclaimed Water Agreement)**





### **2.3.6 Location**

All public reclaimed water lines must be installed in locations per City of Chandler Standard City Detail C-200, C-201 and C-202 unless otherwise determined by the City Engineer. They must have a minimum of 7 feet cover.

### **2.3.7 Acceptable Pipe Materials and Construction Requirements**

Pipe must consist of approved types in accordance with the *List of Approved Products* and must be identified as reclaimed in accordance with MAG Section 616.4.

Construction must conform to MAG Section 616.

Service connections must be isolated from the public distribution system by reduced pressure principle backflow assemblies located at the right-of-way line in accordance with Detail C-404.

All pipe trenches must contain locator wire and identification tape in accordance with MAG Detail 399-1.

### **2.3.8 Reclaimed Water Lines**

Public reclaimed water mains must be 12 inches in diameter on arterial streets, and 8 inches otherwise unless otherwise indicated in the City's Reclaimed Water Master Plan.

Tees must be spaced at a distance no greater than 1/4-mile. Crosses must be installed at the intersection of arterial streets.

All laterals must be a minimum of 8 inches in diameter. Laterals must extend past the edge of existing pavement.

Two valves will be required on each tee (other than service stubs) and three valves will be required on each cross.

Valve box installations must conform to City Detail C-406. In areas not subject to wheel loading, the concrete ring installations must also conform to City Detail C-317.

No valves may be located in sidewalk or ramp areas. All valves must be stationed on the plans. Valve nuts must have a bar welded so as to require a modified tool to operate.

Existing services must be abandoned by exposing the tap at the main and closing the corporation stop.

Refer to the *Reclaimed Water Use Agreement* for specific design details regarding backflow prevention and on-site storage requirements.

### **2.3.9 Construction Plan Requirements**

Reclaimed lines 4 inches and larger in diameter must be shown within the civil plan submittal. All plans must be prepared and signed by a registered professional engineer.

Plans must be submitted on 24" x 36" sheets. The plans must be drawn to an engineering scale with 1" = 20' and 1" = 40' as the preferred horizontal scales. The vertical scale need not differ from the horizontal scale by a precise factor of 10. Water, sewer and paving plans may all be shown on the same plan sheets, if a horizontal scale no smaller than 1" = 20' is used.

All reclaimed lines and utility crossings must be shown in both plan and profile views.

Project Vertical datum must be NAVD 88 with equations to legacy City Datum NGVD 29 and any as-built plans that affect the project. The nearest City CMCN benchmark must be utilized for establishing City Datum.

The engineer must incorporate into the plans the latest copy of the construction *Reclaimed Water Notes*.

The City of Chandler has two policies that should be reviewed: Abandoned Utilities in the City's Right of Way and Private Development Testing Procedures. All utility abandonments within the City's Right of Way will be reviewed on a case by case basis. All proposed abandonments must be shown on a separate plan sheet that documents the demolition of existing utilities. The Developer/Design Professional must confirm that their testing requirements contained within their specifications will meet the City's Private Testing Procedures. Both of these documents are available on the City's Unified Development Manual website.

### **2.3.10 Private Reclaimed Water System Design Considerations**

Unless otherwise determined by the City Engineer. The Private Reclaimed Water System is the reclaimed water system that is downstream of the reclaimed water meter.

#### **2.3.10.1 Turn Out Design**

- a. Large volume users (greater than 250,000 gallons per day annual average) who receive reclaimed water deliveries from the City will be required to construct storage lakes and follow City Detail C-405 for their service connection. The City will control, maintain, and operate all large turnout structures. The Reclaimed Water User will be required to sign a Turnout Operations Agreement. (See Section 5)B.VI). Refer to the specifics of the *Reclaimed Water Use Agreement* for project conditions.
- b. Small volume users (less than or equal to 250,000 gallons per day annual average). These users must design a reclaimed water pumping station to provide peak summer flows for the spray irrigation system between the hours of 10 pm and 6 am. If necessary, the reclaimed water pumping station should include flows for non-spray areas. City Detail C-404 can be used if the Engineer can demonstrate that during peak hour flows:
  - i. The velocity in the pipe between the pump and the turnout is less than 5 feet per second and,

- ii. The estimated available pressure at the suction head is greater than 5 psi.

#### **2.3.10.2 Reclaimed Water Meter**

The City will install the reclaimed water meter. The Engineer must design the reclaimed water system in accordance to City Detail C-301 or C-416. When applicable, the desired location is at an existing reclaimed blow-off service connection.

#### **2.3.10.3 Reclaimed Water Pressure**

See Section 2.3.4. Pressure Considerations.

#### **2.3.10.4 Serving Remote Landscape Tracts**

The Engineer (or developer) may decide which scenario works best to serve disconnected tracts i.e. either potable meter(s) or private reclaimed lines.

#### **2.3.10.5 Standard Location**

When private reclaimed lines are designed to run along private or public streets, the following will apply:

- a. Lines must be installed at 3-foot depth centered under sidewalk (or at least 3 feet back-of-curb or per City Engineer required location).
- b. All lines, 4 inches and larger, and sleeves (see below) must be shown on Civil Engineering Plans.
- c. Additional requirements when located in public rights-of-way:
  - i. Lines must be sleeved with junction boxes at all tees and 90's.
  - ii. Install locator wire and I.D. tape per MAG Detail 399-1.
  - iii. Encroachment Permit is required.

#### **2.3.10.6 Chandler's Potable Water System Protection**

The Private Reclaimed Water System design must protect the City's potable water system from possible Reclaimed Water contamination. At a minimum, the Design Professional must include the following:

- a. When Reclaimed Water is used or will be used on single family residences, a reduce pressure principle backflow assembly must be install as part of the original Private Reclaimed Water System (in accordance to City Detail C-311) on the potable water line serving the single family residence. The Engineer must specify the concrete pad and locking enclosure will not be installed.
- b. Sleeves on private property – When the Private Reclaimed Water System crosses private property and when there is no intention of using Reclaimed Water on the private property, the private reclaimed water line must be installed in a pipe sleeve. Pipe sleeves must be pipe meeting the requirements for the conveyance pipe and must be two nominal sizes larger. Private Reclaimed Water Systems

crossing private property within a public easement must be installed in a sleeve in accordance with this paragraph.

- c. Sleeves crossing public streets or public property - When the Private Reclaimed Water System crosses a public street or public property, the private reclaimed water line must be installed in a pipe sleeve. Pipe sleeves must be pipe meeting the requirements for the conveyance pipe and must be two nominal sizes larger.

#### **2.3.10.7 Protection of the Public Reclaimed Water System**

The Engineer must determine if a backflow prevention assembly is needed on the Private Reclaimed Water system to protect the Public Reclaimed Water System. If needed, the Engineer must determine the location, size, and type of backflow prevention device. If the private reclaimed water system plans on injecting any chemicals into private reclaimed water system, a backflow prevention assembly must be installed.

#### **2.3.10.8 Private Irrigation Lines**

Private irrigation lines are not allowed in City maintained street medians. The onsite private irrigation system must not be tied into City maintained medians in any way.

#### **2.3.11 Reclaimed Water Service Process**

The following describes the process that must be followed before City allows Reclaimed Water to be used on private property. This process must be used for new reclaimed water use or a converting a potable water irrigation system to reclaimed water.

For the purpose of this Section, the term “Reclaimed Water User” means the private entity who signs City’s Reclaimed Water Use Agreement and who is the applicant for ADEQ Type 2 or Type 3 Reclaimed Water General Permit or Reclaimed Water User that receives reclaimed water from the City’s Public Reclaimed Water as outlined in Section 2.3.5.

##### **2.3.11.1 City Contacts**

Development Services: Development Project Administrator (480) 728-3336 and/or Plan Review Manager (480)782-3141

Municipal Utilities: Utility Resource Manager (480)782-3585

##### **2.3.11.2 Submittal Requirements**

The Engineer or Reclaimed Water User must submit TWO copies of the following to the City. Once the City receives all the following documents, the City will begin the process to allow reclaimed water use on private property.

- a. Maricopa County approved irrigation plans.
- b. Maricopa County “Approval to Construct”.
- c. “As-built” drawings of the Private Reclaimed Water Distribution System. The As-Built drawings must show: property lines, all reclaimed water lines, all potable water lines (including the potable irrigation lines), potable water lines to be converted to reclaimed lines, and backflow assemblies. The As Built cover sheet must contain the following statement: “I certify that each property, As Built water

- line, and As Built reclaimed water line shown on this drawing meets the requirements of Arizona Department of Environmental Quality's rules R18-4-215, R18-9-602, and R18-9-704." with the engineer's signature and professional engineering license number under this statement. Each As-Built sheet must be sealed as "As-Built" by an engineer registered in the State of Arizona.
- d. A site map identifying individual lots, common area, and public owed area, and the proposed locations where Reclaimed Water will be or could be applied. An Engineer registered in the State of Arizona must seal the site map.
  - e. Completely filled out and signed "Application for the Use of Reclaimed Water".
  - f. For Large user (greater than 250,000 gallons per day annual average demand) a signed copy of a Turnout Operations Agreement. This Agreement allows the City to access the turnout site, control, maintain, and operate all the large turnout structures. The agreement defines: the responsible party for the equipment and piping, the responsible party for pipe leading into the turnout if the turnout is on private property, the responsible party for the maintenance of the area inside the fence and the fence.
  - g. Encroachment permit application, if necessary.
  - h. An ADEQ letter indicating a valid Type 2 or Type 3 Reclaimed Water General Permit applicable for the property that will be irrigated with Reclaimed Water has been issued.
  - i. A cross connection testing plan, schedule, and report. The plan must be submitted by a State of Arizona approved Certified Cross Connection Control Specialist or by a Professional Engineer registered in the State of Arizona. "Certified Cross Connection Control Specialist" means a Cross Connection Control Specialist approved by ADEQ.
  - j. Pay all permit fees that will include all appropriate plan review, inspection and Reclaimed Water buy-in assessments.

### **2.3.11.3 City Review Process**

The City will review the documents submitted by the applicant, once all the documents have been completed and signed, the City will begin to process the documents.

- a. Once fees are paid and Municipal Utilities has received the required documents, the meter set can be approved.
- b. Applicant must contact Municipal Utilities to schedule a cross connection test.
  - i. Once the City approves the cross connection test plan and schedule, City will coordinate with the applicant the setting of the reclaimed water meter and scheduling of the cross connection test. The cross connection test plan must be signed by a State of Arizona approved Certified Cross Connection Specialist or by a Professional Engineer registered in the State of Arizona.

- ii. Applicant must conduct the cross connection testing in accordance to the approved cross connection test plan. A State of Arizona approved Certified Cross Connection Specialist or by a Professional Engineer registered in the State of Arizona must be present during the cross connection test. City Water Quality staff may be present during the cross connection test. If necessary, City staff may have portions of the cross connection test revised or repeated.
- iii. Upon successful completion of the cross connection test, the City will unlock the reclaimed water meter.
- iv. If the cross connection test is not successful, the City will lock the reclaimed water meter. Once the cross connection test deficiencies have been corrected, process b, c or d, in this section will be repeated.

**2.3.11.4 Post Cross Connection Test**

Upon completion and acceptance of the cross-connection test, the following actions are required:

- a. Applicant must submit to the City, within 10 working days, a cross connection test report. The cross connection test report must be signed by a State of Arizona approved Certified Cross Connection Specialist or by a Professional Engineer registered in the State of Arizona.
- b. A letter from Municipal Utilities stating that the cross connection test was observed and successful. Applicant must submit this letter for County Approval of Construction.
- c. City Close Out Process. Upon receipt of the County's signed Approval of Construction and the cross connection test report, the City will:
  - i. Mail a signed copy of the Reclaimed Water Users Agreement to the Reclaimed Water User.
  - ii. Issue reclaimed water rebates, if any.
  - iii. Issue impact fee refunds, if any.

(Intentionally left blank)

## Chapter 3 - Storm Drainage System Design

### 3.1 **GENERAL INFORMATION**

The purpose of this chapter is to provide guidance for the preparation of drainage studies and construction plans for storm water drainage systems within the City of Chandler.

This chapter also provides guidance and requirements to address stormwater quality concerns to provide for the health, safety, and general welfare of the citizens of Chandler by establishing procedures and practices that will prevent or minimize, to the maximum extent practicable, the discharge of pollutants to City right-of-way or a stormwater collection system. This chapter is intended to set forth City of Chandler requirements relating to preventing non-stormwater discharges during construction activity, not a comprehensive recitation of all other regulatory requirements that may apply to construction activity.

In order to foster uniformity of analytical and technical guidance for drainage design throughout the Maricopa County region, the City relies on the most current version of the Maricopa County *Drainage Design Manual* (DDM) which consists of three volumes: *Volume I Hydrology*, *Volume II Hydraulics*, and *Volume III Erosion Control*.

This chapter presents guidelines applicable to the City of Chandler to be used in concert with those regional documents. Where this chapter does not provide complete guidance, or to meet the needs of the citizens of Chandler, the City Engineer may elect to require other criteria to ensure for their health, safety, and welfare.

#### 3.1.1 **Disclaimer**

City's role in reviewing and permitting projects is limited to verifying general conformance to City requirements. The City does not assume liability for unsuitable design or improper construction. Review and acceptance does not absolve the owner, developer, engineer, or contractor of liability. Additionally, the engineer has the responsibility to design drainage facilities that meet the standards of practice for the profession and public interest. Compliance with the regulatory elements, policies, and design standards does not guaranty that property will be free from flooding or flood damage. The City assumes no liability for information, data, or conclusions prepared by private engineers and make no warranty whether expressed or implied in its review or approval of drainage projects.

#### 3.1.2 **Definitions**

ADEQ: means Arizona Department of Environmental Quality.

AZPDES: means Arizona Pollutant Discharge Elimination System.

BMP's or Best Management Practices: means any methods, techniques, procedures, or practices that may prevent or reduce the discharge of pollutants to City right-of-way or a stormwater collection system. Best management practices may include, but are not limited to; employee training, public outreach, recordkeeping, waste management, schedules of



activities, prohibited practices, maintenance practices, good housekeeping practices, sediment and erosion control, structural practices, chemical storage, disposal practices, and any other processes that may control runoff, leaks, spills, or waste that may be discharged.

**City Right-of-Way:** means property either owned or maintained by the City of Chandler or an easement that is intended for traffic movements, utilities, drainage, and other public uses.

**Construction Activity:** means activity that involves land development including clearing, grading, excavating, disturbing of land and any activities associated with the construction of both commercial and residential structures.

**Detention:** means runoff temporarily detained in a storage facility with delayed and controlled flow.

**Direct Connection:** means any discernible, confined, and discrete conveyance, including but not limited to, any pipe, ditch, channel, tunnel, conduit, well, discrete fissure, container, rolling stock, or concentrated animal feeding operation that may connect to City right-of-way or a stormwater collection system.

**Discharge:** means any addition of pollutants or combination of pollutants that may combine with stormwater runoff or other flows and have the potential to enter City right-of-way or a stormwater collection system.

**EPA:** means United States Environmental Protection Agency.

**ESCP or Erosion and Sediment Control Plan:** means an area site plan or map included in the SWPPP satisfying the provisions of the AZPDES General Permit for Discharge from Construction Activities identifying, among other things, the direction of stormwater flow on the site where construction activity will occur, the area that will be graded or otherwise disturbed during construction activity, site slopes after completion of grading, storage areas, the location of any onsite or nearby water bodies or stormwater collection systems and areas where soil stabilization will occur.

**Illicit Connection:** means any direct or indirect connection or conveyance, whether on the surface or subsurface, which, may cause or allow a non-stormwater discharge.

**Indirect Connection:** means using, leaking, storing, spilling, dumping, allowing, or disposing of pollutants, which may reasonably come into contact with stormwater or other surface flows and enter City right-of-way or a stormwater collection system.

**Low Outfall:** means lowest lot, sub-area, and/or regional elevation outfall for ultimate design of the street/development. May be located within the roadway network.

**Non-stormwater Discharge:** means any discharge to City right-of-way or a stormwater collection system that is not composed entirely of stormwater.

NOI: means the Notice of Intent form to be submitted to the EPA or ADEQ prior to the start of certain construction activities.

NPDES: means National Pollutant Discharge Elimination System.

Off-Site Flows: means runoff reaching development from outside. Includes sheet flow from vacant lands, flow along roadways, and overflows from canals and retention basins.

Person: means any human being, any governmental or political subdivision or public agency, any public or private corporation, any partnership, any firm, association or other organization, any receiver, trustee, assignee, agent, or other legal representative of any of the foregoing or any other legal entity.

Pollutant: means any solid, liquid, or gaseous substances that may have an adverse impact on human health, the environment or may alter the chemical, physical or biological properties of water or contribute to a violation of any federal, state or local water quality standard or a condition of any permit issued to the City. Pollutants include, but are not limited to solid waste, sewage, petroleum based products, pesticides, herbicides, fertilizers, sediment (dirt, sand, mud, rock, etc.), paints, solvents, household or industrial cleaners, biological materials, radioactive materials, chemical wastes, abandoned or discarded objects, toxic wastes, pathogens, litter, incinerator residue, industrial, municipal and agricultural wastes, acids, bases, swimming pool water, pet waste, green waste, construction waste, automotive fluids or other substances that may pose an imminent and substantial danger to public health and welfare or to the environment.

Retention: means contains and disposes of runoff after a storm event.

Significant Materials or Sediment: means any solid, liquid or gaseous substance other than stormwater that causes or may cause or contribute to the violation of a water quality standard pursuant to Article 2, Title 49, Arizona Revised Statutes or the provisions of any permit issued to the City of Chandler.

SWPPP or Stormwater Pollution Prevention Plan (SWPPP): means a written plan that meets the requirements of the AZPDES General Permit for Discharge from Construction Activities that identifies and describes potential sources of pollution which may reasonably be expected to affect the quality of stormwater discharges from construction activity and identifies and describes best management practices that will be implemented and maintained to prevent and/or reduce discharges of pollutants to City right-of-way or stormwater collection systems.

Stormwater: means runoff, surface flows and drainage that is comprised solely of any form of precipitation.

Stormwater Collection System: means all or any part of any publicly or privately owned system or structure designed or utilized to receive, collect, detain, retain, or convey stormwater and any direct connection to such system or structure. Such a system may

include, but is not limited to swales, curbs, gutters, ditches, channels, parks, pipes, watercourses, drywells, culverts, storm drains, catch basins, retention or detention areas, spillways, scuppers, pump stations and common areas.

Waters of the United States: means all waters that are currently used, were used in the past, or may be susceptible to use in interstate or foreign commerce. Such “waters” include, but are not limited to; navigable waters, interstate waters, wetlands, lakes, rivers, intermittent streams, and tributaries of waters identified above.

### **3.2 PLANNING**

Refer to the City of Chandler *Stormwater Master Plan* for City-wide planned projects.

Refer to Maricopa County Flood Control District for Regional Plans that may affect your project on a local and regional level. Also refer to Section 2 – Drainage Planning of the *Drainage Policies and Standards for Maricopa County* as a model for good drainage planning.

Projects must be designed and constructed to comply with all drainage requirements on a stand-alone basis. Projects encompassing more than 160 acres must provide a comprehensive plan that includes consideration for any phasing of the project.

Refer to Section 3.3.16 of this chapter for the City’s requirements for drainage studies based upon permit approvals.

### **3.3 POLICIES**

#### **3.3.1 Purpose**

The policies contained in this chapter reflect the principles by which the City Engineer implements the requirements contained in City Code, as well as the requirements imposed by state law regarding flooding.

#### **3.3.2 General**

The relatively flat topography of the City and general lack of drainage channels necessitate special attention for controlling storm water collection and retention. Policies have been established to minimize storm water problems. Stormwater is in most cases collected and stored for disposal on each site.

Existing irrigation open channels adjacent to a development must be abandoned or piped.

#### **3.3.3 Planning**

Projects must conform to goals identified in previous regional studies as well as the *City of Chandler Stormwater Master Plan*.

#### **3.3.4 Drainage Patterns & Outfall**

Historic drainage patterns must be perpetuated.

Ultimate outfall elevation and location must be determined by considering the surface impediments for complete drainage of flooding. Within the drainage study area, the

drainage engineer must identify each drainage basin's point and elevation of outfall. Additionally, downstream of the project, the engineer must identify locations and controlling elevations limiting free-flow towards the historic regional waterway – the Gila River. These controlling elevations may be grade breaks in the gutter downstream as well as roadway centerline crown elevations. The engineer must demonstrate that there is at least 14 inches of elevation freeboard from the outfall to each finish floor elevation.

Positive drainage must be provided for individual lots in the development site – land must be graded for a minimum 1/2 percent slope.

### **3.3.5 Hydrology**

The following is the preferred order of hierarchy for obtaining peak discharges and runoff volumes for various floodplain and drainage purposes:

- a. Flood Control District studies and flood insurance studies.
- b. Drainage plans and design reports from adjacent properties. This information may be used if approved by the City.
- c. DDM Volumes I – Hydrology and II - Hydraulics.

### **3.3.6 Stormwater Quality**

Projects must conform to requirements of the City of Chandler and applicable Arizona Pollutant Discharge Elimination System (AZPDES) Permits. Refer to Section 3.6.3 of this chapter for requirements including the submission of the Notice of Intent (NOI) and the Erosion and Sediment Control Plan. Permits will not be issued until the NOI has been approved by the ADEQ.

The United States Environmental Protection Agency (EPA) has concluded that polluted stormwater runoff is a major factor in the declining quality of our nation's waters. Stormwater is runoff and surface flows generated from precipitation events. Common pollutants found in stormwater may include, but are not limited to pesticides, fertilizers, litter, pet waste, petroleum products, automotive fluids, paints, solvents, yard waste, sediment, chemicals, metals, materials, and wastes associated with construction activities.

The City of Chandler stormwater collection system manages stormwater to prevent flooding and land erosion and is completely separate from the sanitary sewer system. The sanitary sewer system delivers wastewater from homes and businesses to a wastewater treatment facility where the wastewater is treated and either reused or recharged to groundwater. Stormwater runoff collected in stormwater collection systems is generally not treated before it infiltrates to groundwater or is discharged to Waters of the United States and, as such, it is very important to minimize pollutants that may contaminate stormwater flows.

### **3.3.7 Floodplain Management**

Off-site flows entering the development as a result of the 100-year storm must be accounted for in the conceptual storm water collection and retention plan, but are not required to be included in the retention volume requirements. The point of entry and exit for off-site flows from the 100-year storm must not be altered by the site development from the existing condition. In the case where off-site flows are directed to a retention basin, or the basin watershed is located within the 100-year flood plain, the basin water depth must not exceed 4 feet for the 100-year storm.

Stormwater plans for subdivisions which are located in whole or in part within a Federal Emergency Management Authority (FEMA) 100-year flood zone must be submitted to the Maricopa County Flood Control District (MCFCD) and approved by MCFCD prior to approval by the City. MCFCD requires building final floor elevations to be a minimum of 12 inches above the 100-year flood level. In no case may any finished floor elevation be less than 14 inches above the flood plain low outfall elevation.

### **3.3.8 Erosion Hazard Management**

Erosion and scour at structures and pipe inlets and outlets must be considered and mitigated. Refer to Section 3.6.3 of this chapter for additional requirements including submitting the Erosion and Sediment Control Plan.

### **3.3.9 Street Drainage**

Depth of street flows must be limited in accordance with Section 3.6.4 of this chapter. Any runoff collected along median curb from the 10 year design storm must be intercepted before spilling across roadway lanes.

### **3.3.10 Conveyance Facilities**

Open channels are discouraged and require City Engineer approval. They may be considered if the depth of flow is less than 3 feet and the flow velocity is less than 2.5 feet per second. They must have significant landscaping with side slopes 4:1 or flatter.

### **3.3.11 Storage Facilities**

The rainfall from a 100-year frequency, 2-hour duration storm that falls on a parcel, including adjacent half-streets must be intercepted and stored within that parcel and outside of the City right-of-way. For the purpose of conforming to this requirement, 2.20 inches will be the precipitation used.

Storage facilities must be sized to retain 110% of the design volume due to potential for siltation and variations in construction.

Landscape plans in conformance to City criteria may be required for retention basins. Property frontage utilized for retention will be limited to 50% of the area. Refer to zoning code and conceptual site review and civil checklists for requirements.

### **3.3.12 Stormwater Dissipation**

Drywells are permitted to drain surface retention areas only when no other means of disposal are available. Drywell permits must be registered in the name of the property owner with ADEQ.

All drainage systems must empty within 36 hours. The 100 year design runoff accumulated within permanent lake systems must be dissipated within 36 hours.

### **3.3.13 Ownership and Maintenance of Facilities**

Drainage facilities must be owned and maintained by the property owner.

Homeowner's Associations that own and/or operate drainage facilities must include statements in their Covenants, Conditions, & Restrictions (CC&Rs) and on the recorded final plat clearly identifying that the Homeowner's Association is responsible for regular inspection, operation, maintenance and repair of the drainage facilities, including storm water quality.

Changes to sites require City approval.

A drainage easement must be prepared and recorded with the County Recorder's Office for permanent storm water retention basins.

### **3.3.14 Erosion and Sediment Control During Construction**

All drainage components must be protected from erosion and sediment contamination during construction in accordance with Section 3.6.3 of this chapter.

It is of extreme importance that the public have a record of the constructed project. Projects will not be accepted for completion without certified notations on the approved plans corrected as-built.

### **3.3.15 Post Construction Stormwater Management**

Upon completion of construction activities, the owner of the premises on which such construction activities occurred will either directly or indirectly ensure that all necessary controls are in place and properly maintained to prevent non-stormwater discharges. Such controls include but are not limited to:

- a. inspecting and verifying that the proper design, construction and usage of approved materials associated with all stormwater collection systems are per approved plans;
- b. conducting necessary maintenance to ensure that all components of the stormwater collection systems function properly, including maintenance and stabilization of areas prone to or subject to erosion; and
- c. correcting any deficiencies that are found pursuant to either a City of Chandler or self-inspection.

### **3.3.16 Capital Improvement and Redevelopment/Infill Projects**

As a matter of public interest, the City Engineer may elect to waive certain requirements contained within this chapter. Such waivers must be obtained in writing by the Design Professional prior to project approval. It may not be possible for the City project to mitigate all existing drainage problems upstream or within the project due to project scoping and funding.

When a City project affects existing retention facilities, the design must account for such changes as increased runoff, decreased retention volume available, and differing layout for each development as originally permitted, and provide mitigating accommodations for such changes in the site drainage. The City will not have a duty to quantify the site drainage conditions such as total site required and provided volumes. Existing retention volume must be quantified and reserved for the use by the site. Any deficit to existing retention volume and additional volume caused by changes to the site must be accommodated by the design. The site must continue to be burdened with its existing duty of retaining the runoff from its frontage rights-of-way. The record of requirements must comprise copies of the approved plans, drainage report, and constructed as-builts.

There are existing storm drain systems serving City streets whose capacities are not quantified. Connection to these systems may be permitted on a case-by-case basis to the extent that the City historically has not observed detrimental flooding at the outfall retention basins or excessive ponding at inlets and displaced manhole covers. Contact the Streets Division for citizen complaint and maintenance work records. Also refer to the latest *City of Chandler Stormwater Master Plan*.

For capital improvement projects, the selected consultant must perform a preliminary study of the drainage area that affects the project and identify the scope of work necessary to design facilities to attenuate the adverse drainage impacts. The Consultant must additionally provide in his scope of services an allowance for sufficient infiltration testing to assure that constructed retention basins will drain within 36 hours.

### **3.4 REGULATIONS (FEDERAL, STATE, AND COUNTY)**

Refer to the Maricopa County *Drainage Policies and Standards Manual* for a reference to applicable regulations.

### **3.5 REGULATIONS/ORDINANCES**

#### **3.5.1 Introduction**

Site plans must conform to the *International Building Code* and the *International Plumbing Code*, latest City-adopted edition.

An outline of relevant requirements incorporated in the City Code is presented below. The engineer must review the latest adopted code for changes.



### 3.5.2 City Code Section 45 – Storm Drainage Requirements

City Code Section 45 includes requirements on conceptual drainage plans, basin configurations, retention, disposal, maintenance of basins, and non-storm water discharges.

As set forth in City Code Section 45-8, and subject only to the exceptions set forth in Section 45-8.1 thereof, no person will cause or allow a non-stormwater discharge to City right-of-way or a stormwater collection system. This prohibition includes, without limitation, non-stormwater discharges caused by illicit connections, including direct connections and indirect connections.

As soon as any person has actual or constructive knowledge of any non-stormwater discharge from his or her property, he or she must promptly undertake all necessary steps to discover the source and the extent of discharge and proceed with the appropriate cleanup.

In addition to any other regulatory notice requirements that may apply, any person who has actual or constructive knowledge of any non-stormwater discharge from his or her property, which may result in significant materials or sediment entering into a City right-of-way, stormwater collection system or other property owned by the City, must report such discharge as follows:

- a. if an imminent and substantial danger to public health and welfare or to the environment exists, immediately contact emergency assistance (911). If assistance is needed for the removal of hazardous waste, contact the City of Chandler Environmental Management office; and
- b. for discharges of significant materials or sediment to City right-of-way, City stormwater collection systems or other property owned by the City not involving an imminent and substantial danger to public health and welfare or to the environment, contact the City of Chandler Streets Division of the Public Works & Utilities Department by telephone within 24 hours.

If requested by the City, a follow-up written report must be provided to the City of Chandler Environmental Management Division of the Management Services Department, and to the City of Chandler Streets Division of the Public Works & Utilities Department, within 3 business days of the discharge. The written report may be submitted via mail, email, or in person and must identify the location, source of discharge and pollutant(s), extent of discharge, pollutant(s) discharged and all measures taken to mitigate the discharge. Additionally, if the discharge includes hazardous waste, the report must detail the method of disposal and disposal facility receiving the waste material. The report must also identify all practices that were implemented to prevent similar discharges in the future.

Fugitive dust and sediment generated from construction activities through erosion, wind, and vehicle trackout also have the potential to combine with stormwater to create non-stormwater discharges. Implementation of dust control measures that minimize fugitive



dust and sediment generated from construction activities will reduce the amount of sediment deposited into stormwater collection systems.

### **3.5.3 City Code Section 43-5 – Floodplain Regulation**

City Code Section 43-5 Delegation of Responsibility for Floodplain Management vests the authority for floodplain management with the Maricopa County Flood Control District (MCFCD). Development within areas designated as flood hazard zones will be subject to the rules and regulations established by the MCFCD in conformance with the National Flood Insurance Program and State requirements as well as all City requirements.

The City Engineer will receive requests for permits for floodplain development and will review them prior to forwarding them to the Flood Control District. No permits will be issued until a valid floodplain use permit has been obtained by the applicant. Final City acceptance of the building construction will not be issued until the Elevation Certificate has been accepted by the MCFCD and provided to the City.

### **3.5.4 City Code Section 35 – Zoning Ordinance**

City Engineer requires that Preplats and Site Development Plans must have a conceptual report and plan for approval. City Code Section 35 Article 1902(4)b Retention Basins limit the footprint of certain retention basins and their shapes.

### **3.5.5 City Code Section 48 – Subdivision Regulation**

City Code Section 48 Subdivisions contains requirements for land-division documents. City Engineer requires that Preplats and Site Development Plans must have a conceptual report and plan for approval.

### **3.5.6 Permits**

City Code Section 46-2.D Encroachment Permit Required, requires permits for construction within the right-of-way. City Code Section 47 Offsite Construction Improvement Requirements for Property Development requires permits for development projects.

The City Engineer will require for review and approval the submittal of a Drainage Report wherever development and or grading is proposed within the City limits. Development means any man-made change to improved or unimproved real estate, including but not limited to buildings or other structures, mining, dredging, filling, grading, paving, excavation, or drilling.

## **3.6 STANDARDS**

### **3.6.1 Public Safety**

Depth of ponding in retention basins must be 3 feet. Side slopes must be 4:1 or flatter unless otherwise approved by the City Engineer. Refer to DDM Vol II – Hydraulics Section 1.4 for design considerations to reduce drainage hazards.

Headwall and trash racks / access barriers are required for open ends of pipe 12" in diameter or greater. Basin equalizer pipe with flared end sections may be exempted from this requirement.

A safety rail in accordance with MAG Detail 145 is required along the top edge of structures adjacent to public pedestrian access when the grade difference is 30" or greater. Stormwater structures (headwalls, retaining walls, etc.) which present a fall hazard of 48 inches or greater must have guardrails per MAG Detail 145. Vehicular barriers may also be required. In areas not expected to receive pedestrian travel (fenced off retention basins, etc.), a safety rail is required when fall hazard exceeds 72 inches.

Underground facilities and pipe must be designed for HS-20 vehicular loads.

Grated catch basin inlets must have bicycle-safe grates, those located in the roadway must not intrude into an adjacent bicycle lane.

### **3.6.2 Hydrology**

Rainfall must be based upon the NOAA Atlas 14, Volume 1, Version 5, dated 2011, 90% confidence interval, mean partial duration time series data.

The Rational Method must be used for projects up to 160 acres. Triangular hydrograph methods will not be accepted for urban projects.

Calculations involving retention basin hydraulics, such as equalizer pipe sizing, must consider the 100-year, 2-hour storm distribution as presented in DDM Volume I – Hydrology Section 2.4. Peak intensity occurs between the 60<sup>th</sup> and 65<sup>th</sup> minute, with 27.0% of the precipitation occurring in that interval. Therefore, if an upstream basin has not been sized to store 68.8% of the runoff (the 65<sup>th</sup> minute %-rainfall depth), the hydraulics of the outlet must be based upon peak runoff.

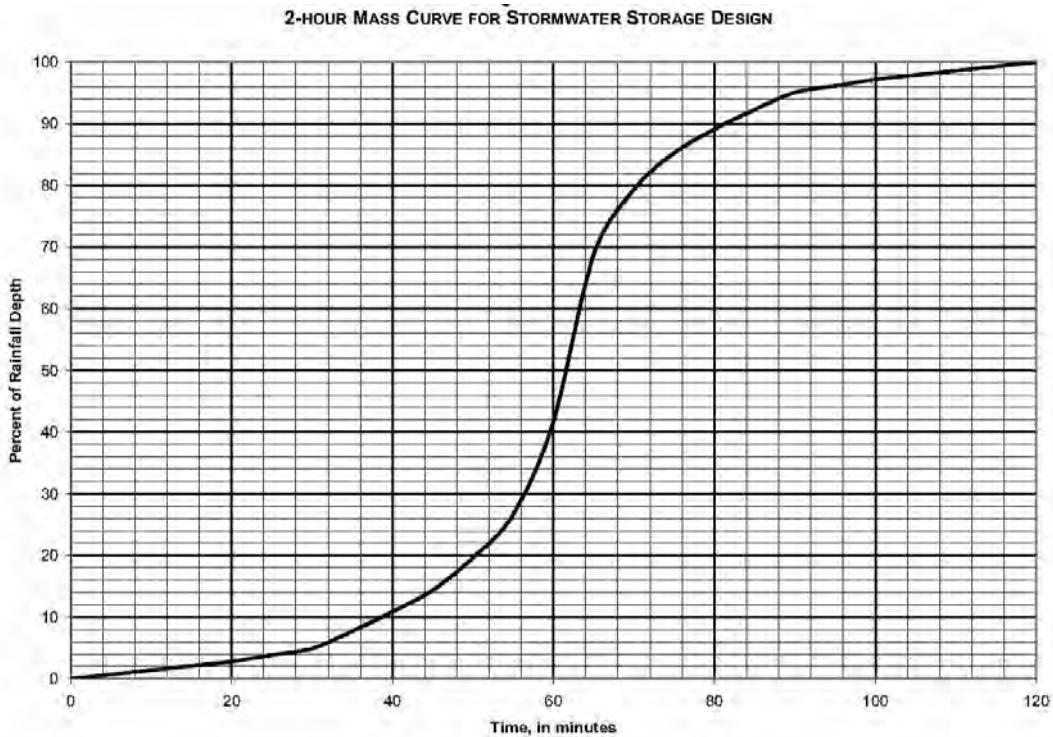
(Intentionally left blank)

**Table 3.1**  
**2-Hour Stormwater Distribution for Stormwater Storage Design (2.2 " of precip)**  
**(ref: DDM Vol. I Sec. 2.4.1)**

TIME (MIN)	RAINFALL DEPTH (%)	INTENSITY (IN/HR)	TIME (MIN)	RAINFALL DEPTH (%)	INTENSITY (IN/HR)
0	0.0	0.00			
5	0.7	0.18	65	68.8	7.13
10	1.4	0.18	70	79.3	2.77
15	2.1	0.18	75	85.3	1.58
20	2.8	0.18	80	89.1	1.00
25	3.9	0.29	85	92.3	0.84
30	4.9	0.26	90	95.1	0.74
35	7.7	0.74	95	96.1	0.26
40	10.9	0.84	100	97.2	0.29
45	14.4	0.92	105	97.9	0.18
50	19.6	1.37	110	98.6	0.18
55	26.7	1.87	115	99.3	0.18
60	41.8	3.99	120	100.0	0.18

(Intentionally left blank)

**Figure 3-A**  
**100 Year, 2-hour Precipitation Curve**  
 (ref: DDM Vol. I Sec. 2.4.1)



**3.6.2.1 Intensity**

Intensity-duration-frequency curves must be based upon a singular location in the City of Chandler: at the intersection of Price and Chandler Heights Roads. (lat. 33.2314 degrees N, lon. 111.8929 W)

**Table 3.2**  
**Intensity Duration Frequency Values**

DURATION	INTENSITY (INCHES/HOUR)	
	10 YEAR	100 YEAR
5 minutes	4.78	7.57
10 minutes	3.64	5.76
15 minutes	3.00	4.76
30 minutes	2.02	3.20
60 minutes	1.25	1.98
2 hours	0.70	1.10

A best-fit equation in the form of  $i = a / (T_c + b)^c$  may be utilized, provided that the resultant intensity values are not less than the NOAA values by 0.05-inch/hour. Refer to HEC12 Appendix 'A' for determining appropriate coefficients. The following coefficients may be used:

**Table 3.3**  
**Intensity Duration Coefficients**

10 YEAR	100 YEAR
45.95	51.2
9.3	7.0
0.851	0.769

**3.6.2.2 Runoff**

Runoff must be calculated based upon the Rational Method.

Time of Concentration ( $T_c$ ) must be utilized for obtaining peak intensity. It must be computed by adding the Initial Runoff Time to the street flow time. The following lag times may be allowed:

**Table 3.4**  
**Runoff Lag Times**

DRAINAGE AREA CHARACTERISTIC	INITIAL RUNOFF TIME (MINUTES)
Single-Family Residential	10
Industrial, Commercial, Cluster Development, Multi-Family	5
Street	0

Time of concentration must be based upon an evaluation of the time of flow in accordance with Manning's velocity. Calculations based upon the Papadakis and Kazan Equation are not acceptable.

Street Flow Time must be calculated by dividing the distance of the longest flow path by the average velocity of the street flow as calculated by the Manning's Equation. In accordance with HEC12, where initial spread is zero, the average velocity occurs where the spread is 65% of the spread at the downstream end of the reach.

Maximum intensity from the i-d-f curve may be obtained from a limiting value of time of concentration of 5 minutes.

The following runoff coefficients must be used for all design frequencies:

**Table 3.5**  
**Runoff Coefficients for Rational Method**

<b>SURFACE</b>	<b>COEFFICIENT</b>
Farm Land	0.10
Grass Lawn (average slope 0-7%)	0.20
Bare Ground (undeveloped vacant lots)	0.25
Grass Lawn (average slope > 7%)	0.35
Undeveloped Desert	0.50
Desert or Rock Landscaping	0.50
Playgrounds	0.60
Impermeable Surfaces (pavement, roofs, etc.)	0.95

**Table 3.6**  
**Weighted Runoff Coefficient**  
**(includes R/W and pavement)**

<b>AREA</b>	<b>COEFFICIENT</b>
Street Right-of-Way	0.95
Commercial or Industrial	0.90
Multi-Family	0.80
Cluster Developments	0.75
Detached Single Family	0.65

**3.6.2.3 Flow**

The Manning's Equation and Modified Manning's Equation must be utilized to calculate flow characteristics. Roughness must be in accordance with DDM Volume II - Hydraulics.

**3.6.3 Construction Site Stormwater Runoff Control**

The requirements in this section relate to managing construction site stormwater runoff control.

### **3.6.3.1 Submission of NOI**

All persons who are required to operate pursuant to a NPDES or AZPDES permit for construction activity (generally those persons engaged in construction activities that will disturb more than one acre (43,560 square feet) of land or less than one acre if part of a larger common plan of development) must, prior to receiving a grading permit, provide a copy of an NOI (including authorization number) processed by the EPA or ADEQ for that construction activity, to the City of Chandler Development Services Department.

### **3.6.3.2 Review of Erosion and Sediment Control Plan (ESCP)**

All persons required to submit a NOI pursuant to Section 3.6.3.1 above must also submit an ESCP to the City of Chandler Development Services Department for review. A grading permit will not be issued until the Development Services Department reviews an ESCP for the area subject to the grading permit for compliance with applicable requirements.

### **3.6.3.3 Dust Control Permit**

All persons required to obtain a dust control permit from the Maricopa County Air Quality Department (generally those persons covered by Maricopa County Air Pollution Control Rule 200, Section 305) who disturb 0.10 acres (4,356 square feet) or greater, provide a copy of such permit for review during a pre-construction meeting or upon request by the City.

### **3.6.3.4 Notice**

The City of Chandler Public Works inspector assigned to the construction site must be notified of the intent to commence construction activities no less than 24 hours prior to actual commencement of construction activities.

### **3.6.3.5 Posting**

A sign or other notice must be posted near the main entrance of the construction site with the following information: AZPDES authorization number for the project or copy of the Notice of Intent if an authorization number has not yet been assigned; name and telephone number of a local office or on-site contact person; a description of the type of construction project; and the location of the SWPPP if the site is inactive or if the site does not have an on-site location to store the SWPPP, and the name and telephone number of a contact person for accessing the SWPPP.

### **3.6.3.6 Compliance with Applicable Law**

All persons engaging in construction activities must comply with applicable law and all permits issued including, without limitation, implementing and maintaining site specific BMP's as described in the SWPPP or elsewhere to prevent significant materials or sediment from entering City right-of-way or a stormwater collection system. Periodic site inspections conducted at the frequency set forth in the SWPPP to ensure that BMP's are operating correctly and have not been damaged or determined to be ineffective, must be documented through completion of inspection logs or reports.

### **3.6.3.7 Checklists and References**

Development Services Department staff may develop and utilize checklists consistent with this manual to implement the provisions of this manual. Development Services staff may also provide citations to potentially applicable reference material and current regulatory contact information to persons attempting to comply with this manual or other non-stormwater discharge regulation requirements.

### **3.6.4 Street Drainage**

Roll curb must conform to MAG Detail 220, Type 'C'.

Valley gutter transverse to through traffic (non-stop controlled) must be 8 feet wide in conformance with City Detail C-233.

#### **3.6.4.1 Street Flow**

Runoff in streets will be limited to the following characteristics by the installation of inlets and underground storm drain conduits.

#### **A. 10 Year Design Storm**

Depth of flow and spread on the pavement must be calculated at the gutter flowline upstream of the local inlet depression. Depth of flow and sump depth at inlets must not exceed the curb height (7" maximum allowable curb height only with approval).

Spread will be limited in the street section by classification:

- a. Arterial and Collectors with Medians – median and adjacent lane each direction must not be submerged.
- b. Other Collectors – single lane in center must not be submerged.

#### **B. 100 Year Design Storm**

Depth of flow must not exceed curb height plus 6 inches. Flow area must be computationally limited to right-of-way. Flows must be limited to 100 cfs and 10 feet per second.

#### **3.6.4.2 Street Inlets**

Scuppers are the preferred inlet type and must conform to C-500. Where design calls for a longer inlet, the inlet must be constructed in whole multiples of the 4-foot cell length. Scuppers must be detailed in profile on the plans, and must be designed and noted such that the retention 100-year design high water surface is outside of the street right-of-way.

When scuppers cannot be utilized, a combination curb opening grated catch basin may be allowed per MAG Detail 533-1. Grated catch basins must be equipped with a bicycle-safe grate.

Grates must be considered to be 50% efficient due to clogging, curb openings: 80%; therefore, required grates must be sized twice as large as design capacity, and required curb openings must be 1.25 times longer than design capacity. Refer also to *Drainage Design Manual for Maricopa County Volume II – Hydraulics*.



The hydraulic grade line for the 10-year design flow from a catch basin must be 6 inches below gutter flow line and must reflect pipe inlet losses. The energy grade line for the 100-year design must not be higher than the calculated depth of ponding of each inlet and must reflect inlet and pipe inlet losses.

All storm drain inlets must be marked with a storm drain inlet pollution awareness marker in accordance with C-508.

Slotted drains are not permitted within the public rights-of-way.

### **3.6.5 Storm Drains**

#### **3.6.5.1 General**

Pipe subject to wheel loading must have HS-20 capacity. Refer to the *City List of Approved Products* for acceptable storm drain pipe materials. RGRCP class of pipe must be identified in the construction drawings profile; see Table 3.7, below. Manning's Roughness values must be in accordance with DDM Volume II – Hydraulics.

Within public streets, storm drain mains must have a minimum 18" diameter and a minimum 15" for laterals. Outside public streets or on-site, mains and laterals must have a minimum 12" diameter. Connections between mains must be constructed with manholes. Prefabricated pipe fittings will only be allowed for drywell connections within 5 feet of an underground retention tank and lateral connections.

Mains must be located a minimum 6' clear of parallel utilities. The main alignment will be located to avoid manholes within the wheel path of traffic. Mains 24" in diameter and larger may have a curved alignment with a radius no greater than 75% of the allowable deflected-pipe radius. Maximum manhole spacing must be 400 feet. Mains must have an invert slope such that the pipe-full velocity is greater than 3 feet per second, and less than 10 feet per second.

(Intentionally left blank)

**Table 3.7**  
**Minimum RGRCP Pipe Class**

PIPE DIAMETER (INCHES)	DEPTH OF COVER IN FEET (FROM SUBGRADE)							
	< 1'	1'-3'	3'-5'	5'-8'	8'-11'	11'-15'	15'-20'	20'-25'
15	V	IV	II	II	IV	IV	V	V
18	IV	IV	II	II	III	IV	V	V
21	IV	IV	II	II	III	IV	IV	V
24	IV	III	II	II	III	IV	IV	V
30	III	III	II	II	III	IV	IV	V
36	III	IV	II	II	III	IV	IV	V
42	II	II	II	II	III	IV	IV	V
48	II	II	II	II	III	IV	IV	V
54	II	II	II	II	III	IV	IV	V
60	II	II	II	II	III	IV	IV	V
66	II	II	II	II	III	IV	IV	Y
72	II	II	II	II	III	IV	IV	V
78	II	II	II	II	III	IV	IV	--
84	II	II	II	II	III	IV	IV	--
90	II	II	II	II	III	II	--	--
96	II	II	II	II	III	II	--	--

Note: Based upon worst case trench and non-trench condition.  
 Loads – AASHTO HS-20.  
 ASTM C-76, B-wall circular pipe.

**3.6.5.2 Water Surface Profile Calculations**

Where there is no other outfall for flows exceeding the 10 year design, the inlet and storm drain must be designed for the 100-year flow.

All storm drain submittals must be accompanied with hydraulic grade line computations prepared in accordance with DDM Volume II – Hydraulics Section 4 Storm Drains and these guidelines.

Computations must account for both the hydraulic grade line (representative of the water surface) and the energy grade line (representative of both the water surface and the energy due to velocity). Generally, computations will proceed upstream from a standing pool

representing the outfall retention basin. The depth of the pool must be considered to be 68.8% of design depth in accordance with Section 6.3. If the outlet is submerged, the energy headloss of quiescent ponding as well any head losses due to outlet structure flow re-direction and/or flow impediment must be considered. If a pipe outlet is unsubmerged, the hydraulic grade line must be considered to intersect the crown of the outlet as the initial elevation for computations.

Computations must consider whether the pipe flows full in determining the appropriate slope of the energy grade line and the types of minor losses.

If the outlet is submerged, match pipe inverts at transitions. Combine transition loss with manhole loss and utilize the main's velocity. Use highest flow velocity for computations at junctions. Account for the headloss of flow re-direction at lateral connections. Computations must include the catch basins and must demonstrate that the 10 year design flow must pond no greater than 6" below the inlet. The 100 year design flow must be analyzed and demonstrated to comply with City requirements.

Utilize minor loss coefficients from DDM Vol II – Hydraulics Table 5.1 for pipe inlets and outlets at catch basins, structures, and headwalls. Include an additional unit  $k=1$  per DDM Vol II equation 4.17 where drainage ponds to enter the pipe network.

### **3.6.6 Equalizers, Culverts, and Bridges**

Refer to DDM Vol II – Hydraulics, Section 5. Equalization pipe between retention basins on private property must be minimum of 10 inches in diameter (and dual 10" pipe is required) and must have flared end sections with scour aprons. For pipes 12 inches in diameter and larger, headwalls and trash racks / access barriers may be required. Hydrologic routing and hydraulic calculations must be provided to demonstrate that the equalization pipe has adequate capacity.

Culvert inlet highwater may not exceed 3 feet unless floodplain flows are a factor, in which case the highwater may reach 4 feet. Any increase in floodplain spread must be confined within a public drainage easement and must not rise to within 12 inches of finish floor elevation.

Bridge design must be performed in accordance with ADOT design/drawing standards. At the City's request, the developer must provide third-party consultant engineer review prior to approval.

### **3.6.7 On-Site**

All on-site storm drain and catch basins must meet requirements per *City List of Approved Products*.

### 3.6.8 Open Channels

Open channels must be designed in accordance with DDM Volume II – Hydraulics procedures. Maximum permitted channel depth is 3 feet, maximum velocity 2.5 feet per second. They must be designed for the 100-year design storm.

### 3.6.9 Hydraulic Structures

Retention basin inlets must be outlet headwall with a trash rack for all pipe ends and openings 12" diameter or greater, conforming to C-503, or a bubbler inlet conforming to C-504 or C-507. Inlets located below basin bottoms must be connected to a drywell or multiple drywells, via a 12" drain pipe at 2% slope in order to drain the storm drain system within 36 hours. Storm drain pipe may outlet to the retention basin directly through the drywell interceptor if the hydraulic grade line calculations demonstrate compliance with criteria. The connector pipe between the drywell interceptor and injector chambers must be located deep enough to drain any connected storm drain system.

The invert of storm drain pipe at outlet headwalls must be 6" above the basin bottom. Erosion protection must be provided.

### 3.6.10 Stormwater Storage

The volume of retention provided must exceed the calculated required volume by 10% due to potential for siltation and construction tolerances.

$V$  (cubic ft) = 1.1 x 100yr 2hr precipitation depth (ft) x tributary basin area (square ft) x runoff coefficient

100yr-2hr precipitation depth = 2.20 inches = 0.183 ft

Stormwater infiltration or disposal which occurs during the storm may not be used to decrease the volume of storage.

Ponded levels may spread on to parking areas on commercial and industrial sites. The required number of parking spaces may not be adversely affected, therefore, the maximum ponding level may not exceed 6 inches and the front 1/3 of the automobile must park on dry pavement.

Certain areas of the downtown, bordered by Ray Road and Pecos Road, between Arrowhead Drive and McQueen Road have reduced onsite retention requirements due to existing storm drain mains and regional retention basins. Construction of lateral connections to the existing storm drain system may be required. See Figure 3-B - Downtown Drainage Areas.

**Table 3.8**  
**Basin Precipitation Depth**

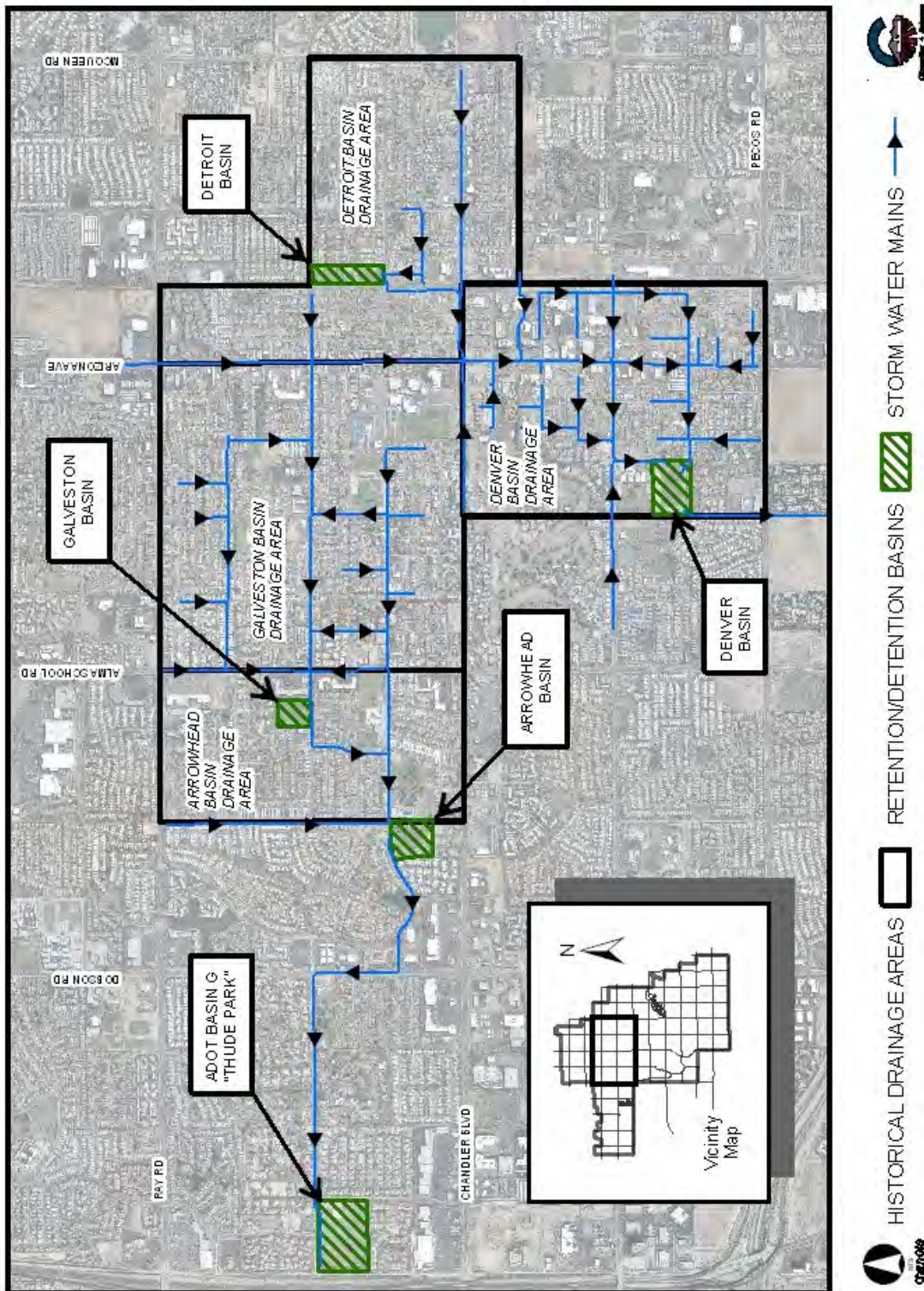
<b>Drainage Area</b>	<b>Design Precipitation Depth</b>
Arrowhead Basin	0.0"
Denver Basin	0.0"
Detroit Basin	0.0"
Galveston Basin	1.2"

Of the four areas, only those sites within the Galveston Basin overlay will be required to store 1.2" of precipitation from its tributary area on site. Developments within the Denver Basin will participate in the Downtown storm drain system.

(Intentionally left blank)



**Figure 3-B**  
**Downtown Drainage Areas**



### **3.6.10.1 Surface Basins**

Surface basins must have side slopes of 4:1 or flatter. Exceptions to this requirement may be granted by the City Engineer for designs with innovation if aesthetics are presented and public safety not compromised. Vertical walls may not be located adjacent to any public street right-of-way. Access to the bottom must be provided for maintenance vehicles. The shape and layout of basins must be reviewed and approved by Planning Division staff for conformance to Zoning Code. Capacity computations must consider berming and amenities. Any required outdoor amenities must be elevated above the 10-year ponding level. No swimming pools may be located within the boundaries of retention basins.

Depth of ponding for the 100-year, 2-hour precipitation must not exceed 3 feet unless a positive method of disposal is provided, under government control.

Permanent retention will not be allowed within the right-of-way. In redevelopment areas where onsite retention is not possible and cases involving extreme hardship, the City Engineer may waive or modify this requirement.

Permanent lakes may be used for retention if the required volume of storm water retention will be disposed of within the required 36 hours.

When roadways are constructed, temporary retention basins may be required until permanent basins are constructed. Temporary basins must accommodate the roadway runoff from the 100yr-2hr storm (2.20 inches) plus 10%, at a level allowing for a minimum of 1' of freeboard to the top of the basin. Any scuppers or piping must be constructed to the permanent size. The temporary basin must be protected from extraneous sheet flow.

For Capital Improvement Projects a minimum 1' berm must be constructed around temporary retention basins located in undeveloped parcels. The basin must include capacity for the runoff incident to its limits and a mulch pit per City Detail C-510.

### **3.6.10.2 Underground Retention Facilities**

Refer to City of Chandler Approved Product list for allowable types of underground retention facilities accepted for use within the City of Chandler jurisdictional boundary. Underground retention facilities may be permitted for sites governed by a property owner's association or property management company. Residential use properties may only use underground retention if they consist of three or more attached dwelling units per structure.

Underground retention storage facilities are not permitted within public right-of-way.

If underground retention storage facilities are located under landscaped or other pervious areas, such areas must be considered impervious (95%) for purposes of calculating required storage volumes.

Non-commercial developments must record CC&R's that include Operations and Maintenance (O&M) requirements. Such O&M requirements must meet or exceed ADEQ and other relevant agencies requirements for drywells. Commercial developments must



prepare documents specifying O&M requirements. All developments must maintain records that document all maintenance performed.

Underground facilities must be located a sufficient distance from property lines so as not to negatively impact future or existing development on the adjacent parcel or parcels.

Roof drains may drain directly to underground retention facilities.

Elevator sumps must not connect to the underground retention facilities.

Overland flow (ultimate outfall) for storms greater than the 100 year 2 hour event must be provided.

All underground retention storage facilities must be installed in accordance with the manufacturer's recommendations. The installation must be inspected by a third party inspection provider certifying that the system has been installed in accordance with the approved construction plans and manufacturer's recommendations. The third party inspection report must be sealed by a Professional Engineer licensed in the state of Arizona.

Pre-treatment of runoff before entering the storage chambers on certain types of underground retention facilities is necessary to prevent degradation of the system. The City Engineer will have sole discretion to determine if pretreatment chambers or other suitable means of filtration will be required for stormwater runoff entering the underground retention facility. Provide a sedimentation chamber, lined with a double-layer filtration geosynthetic Class 1 woven fabric conforming to AASHTO M288, sized to hold ½ inch of drainage area precipitation. The sedimentation chamber must have a manhole suitable for maintenance and clean out.

The foundation for chamber rows connected to a manifold must be protected from scour by a filtration geosynthetic Class 1 woven fabric conforming to AASHTO M288.

The foundation for underground retention storage facilities located underneath drive areas must be characterized by a geotechnical investigation. The report, to be submitted for approval, must recommend allowable bearing capacity for the dry and saturated state subgrade soils, depth of aggregate foundation, as well as double-ring infiltrometer testing to determine the infiltration rate of that subgrade. The geotechnical engineer must document the rationale for determining the number of tests and the methodology for characterizing bearing capacities. Infiltration testing must be conducted in accordance with County methods described in DDM Vol II – Hydraulics Section 9.3.1. Depth of aggregate foundation must be determined from the saturated bearing capacity recommendation in concert with manufacturer's published charts or technical guidance.

The foundation and embedment aggregate must be open-graded, clean, crushed, angular rock, meeting the gradation requirements of AASHTO Specification M43, sizes 3 through 57. The presumptive porosity (volume voids / total volume) for retention computations must be

40%. The open-graded aggregate must be separated from fine grained soils with a moderate survivability separation geosynthetic Class 2 nonwoven fabric conforming to AASHTO M288.

An underdrain system must be connected to a minimum of one drywell. The retained volume must infiltrate through the subgrade and a sufficient number of drywells within 36 hours.

### 3.6.10.3 On-Lot Retention

Items required for submittal with building permit applications where single-family residential lots are subject to on-lot retention include:

- a. Upload the On-Lot Retention Plans electronically under the building plans BLD# (as a separate set of plans). Plans are required to have original seal and signature from a registered civil engineer. Include on the plans: elevations at all property corners, callout the low outfall, bottom elevation, high water elevation (HWE), finish floor and pad elevations.
- b. Calculations for weighted “C” coefficients:
  - i. 0.95 for roof areas, concrete and pavement
  - ii. 0.95 for adjacent half street
  - iii. 0.95 for future pool (min 750 sf) not to be used as retention
  - iv. 0.50 for landscaping, unless a landscaping plan is submitted with application, then use 0.20 for grass and 0.50 for desert landscape
  - v. (Use calculated weighted C value or 0.65, whichever is greater.)
- c. Calculations demonstrating required retention volume for subject property and the adjacent half street:
  - i.  $V_{\text{required}} = CIA * 1.1$
  - ii. Where  $V$ =volume,  $C$ =coefficient calculated above,  $I$  (intensity)=2.2in/hr,  $A$  (sf)=total area (lot + half street) and 1.1 is an additional 10% required for sedimentation.
  - iii. All basins must be connected (6" minimum equalization pipe) or provide separate calculations for each basin.
- d. Calculations demonstrating provided retention volume:
  - i.  $V_{\text{proposed}} = [(area\ of\ the\ top) + (area\ of\ the\ bottom)]/2 * depth\ of\ ponding$
  - ii. 1' depth preferred, 1.5' depth max
  - iii. No underground storage of any kind permitted.
- e. An original as-built plan and calculations, certified by a registered civil engineer, will be required.

- f. Any changes to the single-family lot (including a pool) will require a revised submittal and all the above listed requirements will apply.
- g. Completed Water Retention Addendum acknowledging on-lot retention requirements.

#### **3.6.10.4 Disposal of Stormwater**

##### **A. Basin Infiltration**

The infiltration rate of the bottom surface of proposed retention basins must be characterized by double-ring infiltrometer tests in accordance with ASTM D3385 and DDM Volume II – Hydraulics Section 9.3.1 before grading permit approval. Tests may be required for each separate basin in a project. Submit testing plan for approval to Civil Plan Review Section. Unless otherwise approved, the number of tests must conform to DDM Volume II – Hydraulics Table 9.1.

Each basin must be demonstrated to be dry within 36 hours, by utilizing one-half of the tested basin infiltration rate and drywells.

##### **B. Rock Pit**

The use of rock and mulch pits will be limited to case-by-case City Engineer approval. An open-graded stone must be used and separated from adjacent fine-grained soils by a non-woven, moderate survivability separation geosynthetic fabric. The infiltration rate for the surfaces of proposed rock pit must be characterized by a double-ring infiltrometer test in accordance with ASTM D3385 and DDM Volume II – Hydraulics Section 9.3.1 before grading permit approval.

##### **C. Drywell**

Drywells must conform to C-501 or C-502. Where drywells are located within the same watershed of petroleum product storage or dispensing areas, the drywells must be oil interceptors in accordance with C-502.

Drywells will be permitted where there is inadequate surface infiltration. For design and permitting purposes, each drywell must have a presumptive capacity of 0.1 cfs (12,960 cubic feet in 36 hours). During construction, each drywell must be field tested. Credit may be allowed towards the total remaining drywells to be constructed at one-half of the tested capacity, limited to 0.5 cfs. That is to say, in the most favorable condition, one drywell with a field test of 1 cfs or greater may offset the need to construct 4 additional drywells.

Drywell rim grades must be flush with road surface or turf and must be 1-1/2" above decomposed granite landscaped areas.

Drywells must conform to ADEQ *Guidance for Design, Installation, Operation, Maintenance, and Inspection of Drywells*. They must be registered with ADEQ (US EPA during primacy

application interim period) and must be constructed by an ADEQ-licensed contractor. Registration numbers must be delivered to City at the time of project acceptance.

Drywells must penetrate at least 10' into a permeable stratum.

Drywell locations must be shown on the grading plans with identifying number. The as-builts grading plan cover sheet must contain a log of each drywell with its registration number and percolation rate.

Drywells must be located a minimum of 100' apart, unless otherwise waived by the City Engineer. Drywells must be located 20' from the basin inlet. Drywells must be located a minimum of 100' from water wells and underground gasoline storage tanks. Privately-owned drywells must not be located in public right-of-way or private street tracts without the City Engineer's authorization. Any drywell within the right-of-way may only accept drainage from the public right-of-way.

The property owner will be responsible for the design, performance, operation, and maintenance of drywells on his property. Drywells that cannot drain retention areas within 36 hours must be replaced with new ones.

#### **D. Recessed Loading Docks**

Recessed loading docks without positive drainage to a surface retention basin must be constructed with a sump pit and manual switch pump to pump accumulated storm water to daylight.

Multiple loading docks may be interconnected to one central sump pump with a manual switch.

Under no circumstances will storm water runoff from a recessed loading dock be directly connected into an underground retention tank, bubbler structure or other underground facility directly connected to a drywell.

#### **3.6.11 Pump Stations**

Pump stations must comply with DDM Vol II – Hydraulics Section 10, except as noted:

- a. Pumping facilities must be set at an elevation above the 100-yr event, considering power failure.
- b. Screening devices will not be used at the entrances to the pump station. Grates must be used on catch basins.

#### **3.6.12 Sedimentation Maintenance**

##### **3.6.12.1 General**

All drainage, flood, and erosion control facilities must be regularly maintained. Accumulations of silt, trash, litter, or stagnant water which create a health or safety hazard or which endanger the design function are not permitted. Excessive growth or woody

vegetation in channels and on dams or levees must be removed. Areas of active wind or water erosion must be protected with surface treatments.

Private drainage, flood, and erosion control facilities must be maintained. Adjacent upstream or downstream public or private facilities must not be damaged or endangered.

### **3.6.12.2 Retention Basins**

Silt removal must occur when silt depth exceeds 6 inches outside of the sediment traps.

Basin bottom infiltration surfaces which are non-vegetated must be scarified to break up silt and surface crusting annually without using equipment that is detrimental to the infiltration surface.

### **3.6.12.3 Drywells**

Any loss of efficiency due to screen clogging and accumulation of silt must be remedied by jetting with water and compressed air. The interception chamber of the drywells traps heavy sediments and trash. They must be cleaned periodically as described below. The construction and maintenance of a sediment trap around the inlet can reduce the sediment in the chamber.

#### **A. Inspection**

Inspections must be performed annually or when ponding remains 36 hours after a storm. Inspections must be documented using the ADEQ inspection checklist form and retained on file by the owner.

Maintenance must occur when:

- a. For drywells in paved areas – when 10% of capacity of the interception chamber is filled with sediment and debris.
- b. For drywells in landscaped areas – when 20% capacity of the interception chamber is filled with sediment and debris.
- c. When drainage time exceeds 36 hours.
- d. Non-storm water discharge has entered the drywell.
- e. Upon change of ownership.

#### **B. Maintenance**

Maintenance must include:

- a. Dirt and debris removal.
- b. Replacement of petrochemical absorbent and any filter fabrics.
- c. Cleaning of the screens.
- d. Opening of liner weep holes.
- e. Purging of silt accumulated in aggregate by jetting, surging, or pumping.

If inspection determines that the drywell is not effective, and cannot be restored to service, a new drywell must be installed.

### **3.6.13 Hydrology and Hydraulics Reports (Non-FIS)**

Project datum must be NAVD 88 with equations to legacy City Datum NGVD 29 and any as-built plans that affect the project. The nearest City CMCN benchmark must be utilized for establishing City Datum.

#### **3.6.13.1 Conceptual Drainage Report**

The City requires for review and approval that a conceptual storm water collection and retention plan be submitted with a preliminary plat or site development plan and approved prior to the approval of such plat or plan. The storm water plan must include, but not be limited to, the following by City Code:

- a. Method of collection (surface and/or subsurface).
- b. Depth, side slopes and volume of retention basins.
- c. Calculations showing retention required and provided.
- d. High-water elevation, pipe inverts and site outfall.
- e. Method of disposal of water within thirty-six (36) hours.
- f. Results of percolation test.
- g. Areas tributary to each retention basin.
- h. The effect of a basin overflow due to back-to-back storms or a storm greater than the design storm.
- i. Any other data required to form a complete plan.
- j. Identify long-term maintenance responsible party.

Additionally:

- a. The watershed boundaries, both on-site and off-site, must be delineated on the drainage map. Indicate any existing drainage or irrigation structures such as waste or delivery ditches, natural drainage channels, etc., and the proposed development's impact on existing features.
- b. A topographic map which shows the location of the project area; a 1- or 2-foot contour interval must be used as the base map for both existing and proposed. The map must also show the location of the property with respect to the street system and other features such as existing and proposed storm water retention basins, RWCD Canal, Consolidated Canal, etc.
- c. Method of collection (surface and/or subsurface).
- d. Depth, side slopes, and volume of retention basins.
- e. Calculations showing retention required and provided. Provide a summary table, itemizing individual drainage area values for required storage and provided. Demonstrate that the gross project acreage has been considered.
- f. Method of disposal of water within 36 hours.
- g. Areas tributary to each retention basin.
- h. Discuss the development's low outfall elevation and location relative to City and County datum. Indicate location on all watershed and topographic maps.

- i. Indicate the drainage pattern of all streets within and adjacent to the proposed development on the drainage map.
- j. Present a preliminary retention basin plan including size, depth, and possible methods of draining the retention basin.
- k. Indicate areas within the 100-year floodplain.

### **3.6.13.2 Final Drainage Reports**

Paving, grading and site construction plans submitted for approval must be accompanied with a drainage report that includes:

- a. Cover sheet: submittal number, name, and address of project, parcel, or development for which the report is submitted. Include name, address, and phone number of engineer and property owner.
- b. A narrative with topographic maps that describe the location and condition of the property the project is located on (on-site conditions); and the upstream (off-site) watersheds as well as any downstream constraints which affect the property.
- c. Provide calculations demonstrating required retention volume, tributary areas to each basin, and volume provided. Indicate basin grades, depth, high water elevation, pipe invert elevations, basin outfall elevation, and side slopes.
- d. Provide elevation and indicate location of low outfall elevation for the development, sub area or site improvement.
- e. Describe the effect of a basin overflow due to back-to-back storms or a storm greater than the design storm.
- f. Provide street and pipe capacity calculations for the 10-year and 100-year storm.
- g. Provide time of concentration calculations.
- h. Provide drainage area map. Map must have lots and streets labeled, drainage areas and concentration points labeled. Curb height changes noted. Street grade and flow arrows.
- i. Discuss Flood Insurance Rate Zone.
- j. Provide storm drain piping and catch basin hydraulic calculations.
- k. Indicate the routing of off-site flows through or around the proposed development.
- l. Indicate the County datum to which all site and facility elevations are referenced and equate to the City benchmark.
- m. Indicate tailwater and backwater elevations at all culverts.
- n. Indicate finished floor elevations of all structures.
- o. Indicate method of disposing of retained storm water within 36 hours and provide double-ring percolation test results and calculations and project geotechnical report.
- p. Indicate inflow and outflow points at retention/detention basins and culverts.
- q. Indicate points of concentration and intake point for catch basins, scuppers, channels, and street intersections.
- r. Calculations of the number of drywells.



- s. Drainage report based upon computerized hydraulic models must have all values and variables identified in the report. Software manuals and documentation must be made available upon request by the City.
- t. Long-term maintenance responsibility: Specify the name, address, and phone number(s) of the person(s), firm(s), or agency responsible for ownership, operation, liability, and maintenance of drainage improvements. List other documents where these responsibilities are documented (i.e., CCRs, final plats, etc.).
- u. Water surface calculations.

The following calculation as required:

- a. Calculations for earth-load and HS-20 live-load on buried pipe. Calculations for required pipe strength (D-Load on reinforced concrete pipe).
- b. Channel hydraulics.
- c. Special structures.

The following is a suggested outline for a drainage report:

- a. Table of Contents
- b. Introduction
- c. Purpose
- d. Watershed Boundaries
- e. Existing Conditions
- f. Landform
- g. Regulatory Setting
- h. Federal
- i. Local
- j. Offsite Drainage Conditions
- k. Drainage within the Project
- l. Proposed Improvements
- m. Project Impact
- n. Hydrology
- o. Rainfall
- p. Runoff
- q. Hydraulics
- r. Street Flow
- s. Inlet Performance
- t. Pipe Systems and Capacity
- u. Stormwater Storage
- v. Stormwater Dissipation
- w. Basin Infiltration
- x. Drywell
- y. Handling the Extraordinary Storm Event

- z. Outfall
- aa. Appendix A – Drainage Area and Peak Flow Computations
- bb. Appendix B – Catch Basin Interception Computations
- cc. Appendix C – Hydraulic Grade Line Calculations

### **3.6.14 General Construction Drawing Requirements**

#### **3.6.14.1 Plan Approval**

- a. All pipes must be shown in profile.
- b. Professional Registrant
- c. 24x36" plans
- d. 20 or 40 scale
- e. Need landscaping plan for retention basins. Comply with zoning code and conceptual site review and civil checklists.

#### **3.6.14.2 Project Acceptance (As-Built Approval)**

Following completion of storm drainage improvements, an As-Built final grading plan must be submitted for approval. The plan must be sealed by a Civil Engineer and a Registered Land Surveyor each registered in the State of Arizona. Plans must be marked As-Built with all changes noted. As-Built drawings must contain the following:

- a. Certification of catch basin inlet and outlet elevations.
- b. Certification of retention basin dimensions, grades, volumes, and side slopes.
- c. Certification of retention basin percolation rate, both the pre-construction and the post construction double-ring infiltrometer tests must be submitted.
- d. Approved ADEQ (US EPA during primacy application interim period) drywell registration, drilling logs, and certified testing results with key to location on plan.
- e. Show the As-Built maximum water depth of the retention basin for a 100-year, 2-hour storm.
- f. Show the As-Built finished floor elevation of buildings and or building pads and the As-Built elevation of the development low outfall.
- g. Present final plan for carrying runoff from outside the proposed development (through or around the development).
- h. For projects constructed within regulatory flood insurance areas, flood plain limits, elevations and permit number must appear on As-Built. An approved MCFCD Elevation Certificate must be submitted with the As-Built plan.

### **3.6.15 References**

#### **3.6.15.1 Drainage Policy and Standards Manual for Maricopa County**

- a. <http://www.fcd.maricopa.gov/Pub/manuals/policy.aspx>

#### **3.6.15.2 Drainage Design Manual (DDM):**

- a. Volume I - Hydrology:  
<http://www.fcd.maricopa.gov/Pub/manuals/hydrology.aspx>

- b. Volume II - Hydraulics:  
<http://www.fcd.maricopa.gov/Pub/manuals/hydraulics.aspx>
- c. Volume III - Erosion Control:  
<http://www.fcd.maricopa.gov/Pub/manuals/erosionControl.aspx>

**3.6.15.3 HEC 12:**

- a. <http://www.fhwa.dot.gov/engineering/hydraulics/pubs/hec/hec12.pdf>

**3.6.15.4 NOAA Atlas 14 Precipitation Frequency Data Server:**

- a. [http://hdsc.nws.noaa.gov/hdsc/pfds/pfds\\_map\\_cont.html?bkmrk=az](http://hdsc.nws.noaa.gov/hdsc/pfds/pfds_map_cont.html?bkmrk=az)

(Intentionally left blank)

## **Chapter 4 - Street Design and Access Control**

### **4.1 GENERAL INFORMATION**

All streets within, and adjacent to developments must be improved to City Standards. The developer is responsible for all costs associated with the required improvements.

Functional classifications for principal arterials and major or minor arterial streets are contained in the City's latest Transportation Master Plan. Functional classifications for other streets will be determined by the Public Works & Utilities Director or his designee. Minimum required rights-of-way widths must be in accordance with the City Code.

A traffic analysis by a traffic consultant is required for proposed developments determined by the Public Works & Utilities Director or his designee to have a large impact on the street system. The required elements of the traffic analysis are contained in Section 5 Traffic Impact Studies. The developer is responsible for the costs of the analysis as well as the costs for implementing the recommendations of the analysis.

Improvements to pedestrian design facilities must meet the accessibility requirements of the Americans with Disabilities Act (ADA).

#### **4.1.1 Definitions**

For the purposes of this chapter, the following definitions are used:

**Alley:** A public thoroughfare that affords only a secondary means of access to abutting property.

**Developer:** The individual, firm, corporation, partnership, association, syndicate, trust, or other legal entity that files the application and initiates proceedings for the development and/or subdivision of land in accordance with the City Code and said developer need not be the owner of record of said land.

**Easement:** A grant by the owner for the use of specified land by the public, a corporation, or persons, for specific uses and purposes and so designated and recorded in the county recorder's office.

**Intermediate intersection:** The intersection of any collector or local street or major driveway with any major or minor arterial functioning as the through roadway.

**Major intersection:** The intersection of any principal arterial (freeway or expressway) major or minor arterial with any major or minor arterial. These intersections are typically found at

the section corners as the section-line roadways intersect. The intersection of two principal arterials normally requires an interchange.

Major generator: Any development (commercial, industrial, residential, or mixed use) which generates more than 5,000 trips per weekday.

Major driveway: Any driveway, which intersects a major or minor arterial and serves the main parking area of a major generator, with all movements permitted.

Minor driveway: Any non-major driveway, which provides access to a major or minor arterial. The access can be full, i.e., all movements permitted, or with certain movements restricted.

Median: A raised or flush area designed to separate and control vehicular movement.

Pedestrian Way: A public walk dedicated entirely through a block from street to street and/or providing access to a school, park, recreation area or shopping center.

Right-of-Way: Any land which by deed, conveyance, agreement, easement, dedication, usage, zoning condition, process of law or other means is reserved for or dedicated to the general public for street, highway, alley, public utility, or pedestrian walkway purposes and accepted by the City.

Street: Any existing or proposed street, avenue, boulevard, road, bridge, viaduct, or easement for public vehicular access or a street shown in a plat duly filed and recorded in the county recorder's office. A street includes all land within the street right-of-way whether improved or unimproved and includes such improvements as pavement, shoulders, curbs, gutters, sidewalks, parking spaces, bridges, viaducts and traffic-control devices.

- a. Arterial Street: A major street of exceptional continuity that is intended to carry the greater portion of through traffic from one area of the City to another and is generally positioned at one-mile intervals. Major and minor arterials are designated in the current City Transportation Plan.
- b. Collector Street: A street designed with the primary purpose of collecting and distributing traffic, to and from, arterial streets.
- c. Local Street: Typically, a street of limited continuity with the primary purpose of serving only those lots, which are adjacent
- d. Cul-de-sac: A short local street having but one end open for vehicular traffic, the opposite end being terminated with a permanent turnaround.
- e. Private Street: A street not owned or maintained by the City.
- f. Public Street: A street owned and maintained by the City.
- g. Driveways:
  - i. Commercial Driveway: Access for retail, office, high density residential or government/community service building.

- ii. Industrial driveway: Access for large industrial, office park, mixed use, or warehouse developments, which may also accommodate heavy truck movements.
- iii. Residential driveway: Access to single-family residence from local or collector street only. New access from an arterial street is not allowed in the city.
- iv. Private shared driveway: driveway serving more than one lot.
- v. Parking lot access way: Access to and circulation among parking areas within an integral apartment or townhouse complex.

#### **4.1.2 General**

The design standards presented within this chapter should be treated as minimum standards. The American Association of State Highway and Transportation Officials (AASHTO) has published several design standard policies. Should a conflict between this chapter and an AASHTO policy occur, the City's standards or policies will apply.

All traffic control signs and pavement markings must be in accordance with the Manual on Uniform Traffic Control Devices (MUTCD) prepared by the U.S. Department of Transportation and the City of Chandler's Standard Details. All traffic control materials used must conform to Arizona Department of Transportation Standard Drawings and Specifications (ADOT) unless otherwise noted.

The City Engineer may promulgate additions or revisions to the standards as needs arise.

Each successive phase of a development must satisfy all of the requirements given within this chapter. In addition, all arterial street improvement requirements must be satisfied with the first phase. In the case of large developments, the City reserves the right to require satisfaction of collector street improvement requirements with the first phase.

Right-of-way width and required improvements for each street classification are found in the City Standard Details. Newly constructed and reconstructed arterial streets are to be designed to accommodate on-street bike lanes, except where the necessary street width is not feasible because of right-of-way or existing development constraints. Bike lanes are to be marked on collector streets selected by City staff in consultation with the developer or neighborhood representatives.

A brief summary of the City's design standards is shown in Table 4.1. Each of the design standards is discussed in detail in the following sections.

## **4.2 ROAD ELEMENTS**

### **4.2.1 Alignment**

#### **4.2.1.1 Horizontal Alignment**

The minimum horizontal centerline radii shown in Table 4.1 are for normally crowned streets. The use of super-elevation to reduce the minimum horizontal centerline radii is prohibited on all streets except arterials. Super-elevation may be used on arterial streets upon approval of the Public Works & Utilities Director or his designee, providing the street

cross-slope does not exceed 4.0%. The City reserves the right to modify the design speeds shown in Table 4.1 for arterial and collector streets when justified by special circumstances where overall safety is not compromised.

For special cases where the minimum tangent lengths shown in Table 4.1 cannot be achieved, the Public Works & Utilities Director or his designee may approve reduced requirements providing that sight distance and overall safety are not compromised. In general, intersection tangents will not be required where the radii for both streets are 400 feet or greater.

All street intersections with arterials or major collectors must be at 90 degrees. All other street intersections must not vary from 90 degrees by more than  $\pm 15$  degrees.

Horizontal curves are not required when the necessary alignment change can be accomplished with a taper. Taper requirements are given below:

a. For Redirection of Through Lanes:

$$\begin{array}{ll} \text{For Speeds } \geq 45 \text{ MPH,} & L = S \times W \\ \text{For Speeds } \leq 40 \text{ MPH,} & L = \frac{WS^2}{60} \end{array}$$

b. For Entry Into Turn Bays:

$$L = \frac{S \times W}{3} \quad \text{Where} \quad \begin{array}{l} L = \text{Taper Distance in Feet} \\ S = \text{Speed Limit in Miles Per Hour} \\ W = \text{Offset Distance in Feet} \end{array}$$

Length, L = 100 feet minimum, and should be extended as required by sight distance conditions.

Please note that these taper requirements also apply when narrowing the improved street width, and may apply to widened sections if traffic lanes are being offset.

Desirable cross-street intersection spacing along arterial streets is at quarter-mile intervals. Intermediate intersections may be located a minimum of one-eighth mile from the nearest major intersection with a maximum of five intersections permitted per mile of arterial street. Desirable minimum distances between cross-street intersections are 125' along local streets, 250' along collector streets with no raised median, and 400' along collector streets with a raised median.

The maximum allowable block length is 1,200 feet and, generally, the maximum allowable length of cul-de-sac is 400 feet, measured from the intersection of the right-of-way lines at the throat to the extreme end of the bulb. Generally, "dog-leg" type cul-de-sacs are discouraged.

Bubbles are normally constructed at all two-legged intersections on local streets, see Figure 4-A.



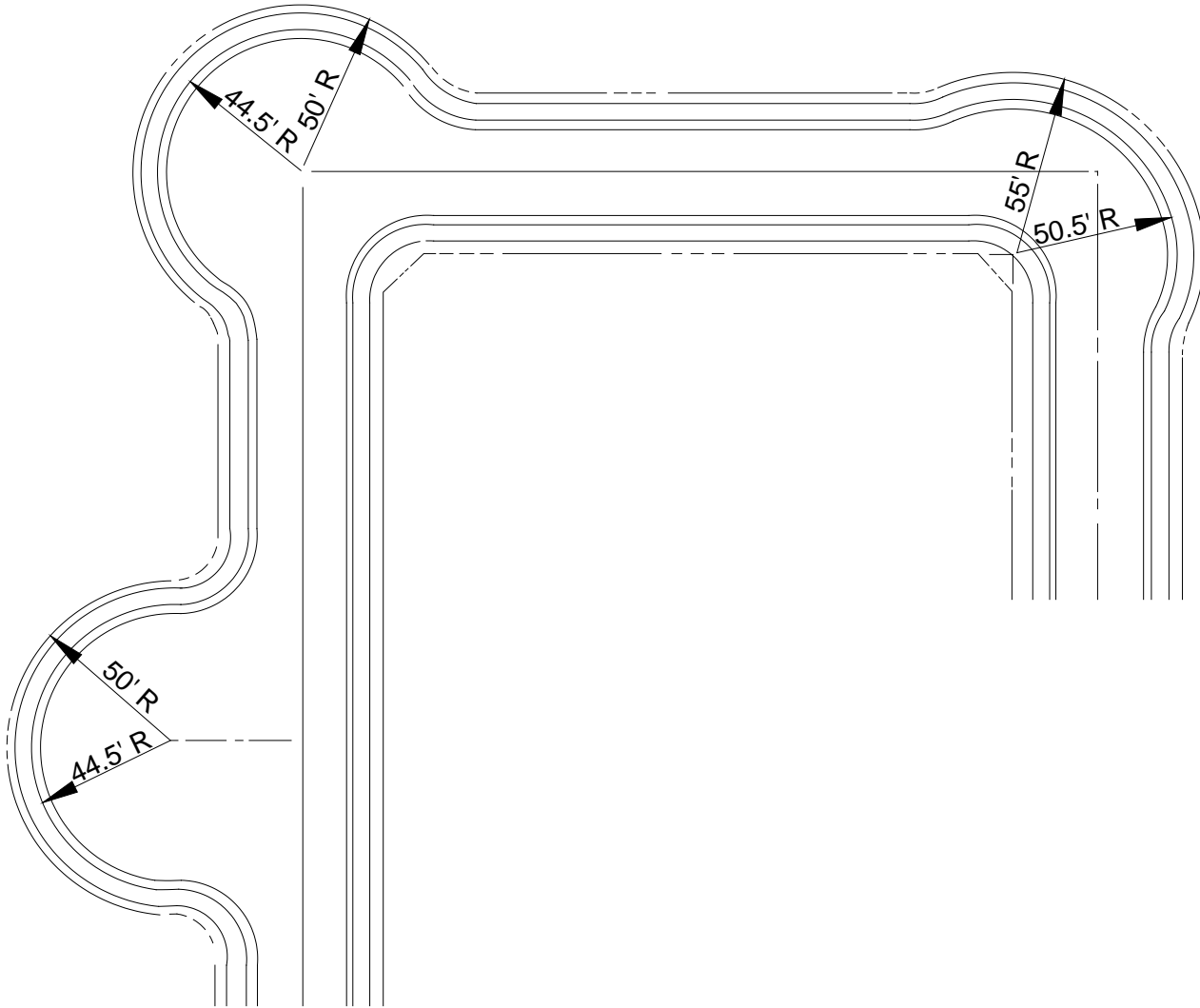
**Table 4.1**  
**Summary of Design Standards**

ITEM	ARTERIAL	COLLECTOR	LOCAL
Design Speed (mph)	55	40	25
Minimum Horizontal Centerline Radius (ft.)	1,800	700 (with driveways)  400 (no driveways)	250 (with driveways)  150 (no driveways)
Minimum Tangent Length at Intersections (ft.) (measured from intersection center line) *	550	300	150
Cross Slope (%)	2.5–3.0	2.0–3.0	2.0–3.0
Maximum Longitudinal Slope Change Not Requiring a Vertical Curve (%)	1.0	2.0	2.0
Stopping Sight Distance (ft.) Height of Eye 3.5 ft., and Object Height 6 in.	495	305	200
Minimum Vertical Curve Length, Crest (ft.) A=Algebraic Difference in Grades (%)	220 x A	80 x A	20 x A
Minimum Vertical Curve Length, Sag (ft.) A=Algebraic Difference in Grades (%)	130 x A	70 x A	30 x A

\*Not required on a local or collector street approach with a centerline radius  $\geq$  400 feet or more.

(Intentionally left blank)

**Figure 4-A**  
**Bubbles for Streets**



**4.2.1.2 Vertical Alignment**

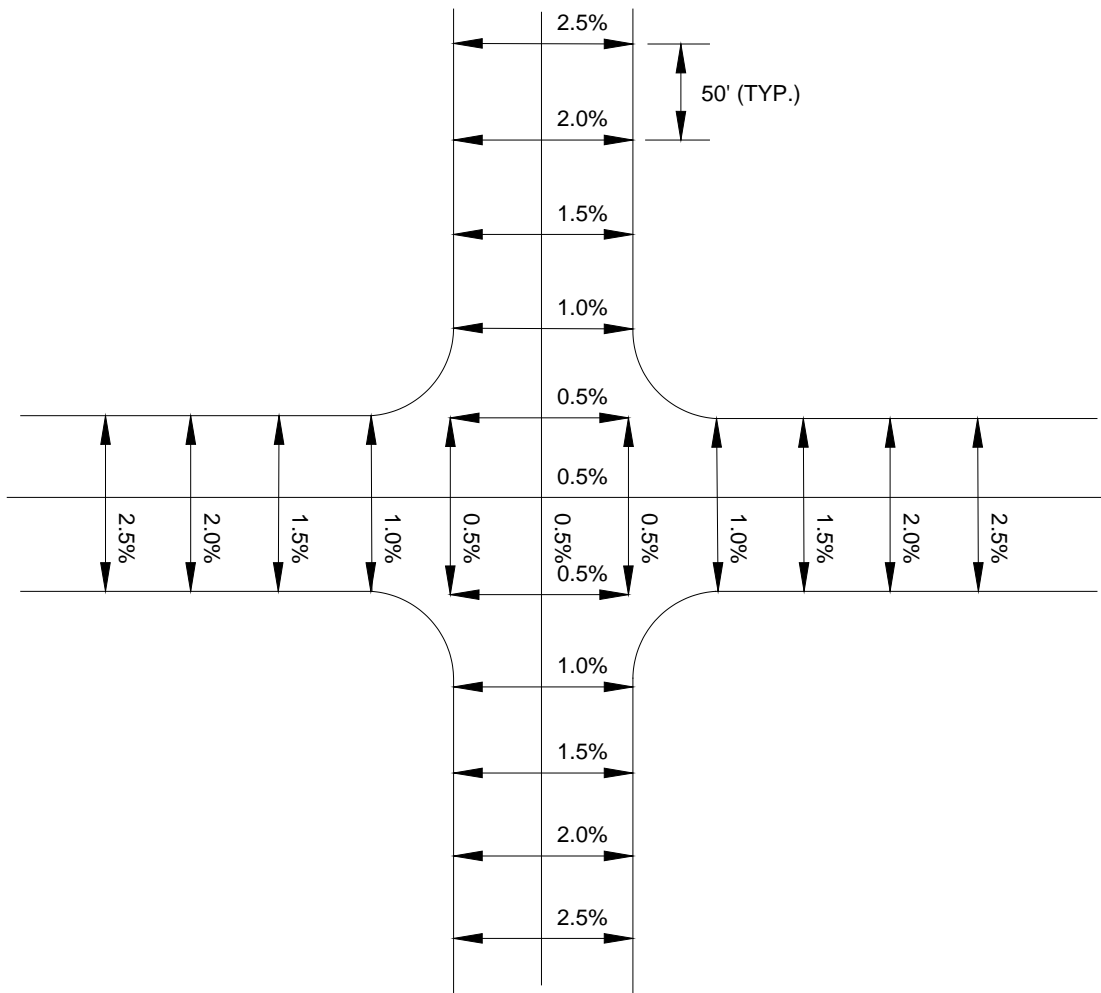
Variations to the slope requirements shown in Table 4.1 may be approved by the Public Works & Utilities Director or his designee if the following conditions are met:

- a. The variance must be justified on an engineering basis,
- b. No alternatives are available,
- c. Safety is not compromised,
- d. Drainage problems will not be created, and
- e. The variance benefits the City.

The minimum vertical curve lengths shown in Table 4.1 are preferred values. The Public Works & Utilities Director or his designee may approve shorter lengths if justified by a detailed analysis and if safety is not compromised.

A design aid for street cross-slopes at intersections along arterial streets and along major collector streets is presented in Figure 4-B. This figure should be treated as a conceptual guideline, not an absolute requirement. The objective of this design aid is to provide for the smooth flow of traffic through intersections. The street longitudinal and cross slope requirements shown in Table 4.1 do not apply within the intersection, except for the maximum longitudinal slope change not requiring a vertical curve. However, positive drainage must still be achieved.

**Figure 4-B**  
**Design Aid for Major Intersection Cross-Section**



#### 4.2.2 Road and Right-of-Way Widths

In general, right-of-way widths must follow City Details C-203 – C-223.

#### **4.2.2.1 Public Streets**

##### **A. Arterials**

All newly constructed or reconstructed arterial streets must be marked with bike lanes. Arterial street bike lanes must generally be 5 feet wide, not including any part of an adjacent gutter pan. Vehicle lane widths on a six-lane arterial street must be 12 feet for lanes next to the median and next to the bike lanes, and 11 feet for the center through lane in each direction of flow. See City Detail C-619.

For remarking of existing arterial streets, lane widths are as follows:

- a. A two-way left turn lane must be at least 10 feet wide, 10.5 feet preferred.
- b. A vehicle through lane must be at least 10.5 feet wide, 11 feet preferred.
- c. A vehicle through lane next to a median curb or bike lane must be at least 11 feet wide, 12 feet preferred.
- d. A bike lane must be at least 4 feet wide, but the bike lane must be increased to a width of 5 feet where possible with the preferred vehicle lane widths listed above. Gutter pans must not be included in the measurement of bike lane widths.

Along existing arterial streets too narrow to provide bike lanes, the outside lane will be made as wide as possible by using the minimum vehicle lane widths described above for the center and inside lanes.

##### **B. Collectors**

A 45' collector road (to back-of-curb) may be striped in a number of ways to accommodate vehicular traffic, bikes, and on-street parking. Three typical configurations are shown below:

- a. An 11' two-way left turn lane (TWLTL), one 11' travel lane and 4' bike lane (as measured to the lip-of-gutter) in each direction.
- b. A straight centerline with a 14' travel lane and 8' parking lane (as measured to the face-of-curb).
- c. A straight centerline with a 12' travel lane, a 3.5' hatched buffer, and 5' bike lane (as measured to the face-of-curb) in each direction.

#### **4.2.2.2 Private Streets**

Private streets are subject to all of the requirements for public streets except for the minimum allowable widths shown in Table 4.2. Continuous through streets cannot be comprised of both public and private roadway sections.

Street name signs, City Details C-601 and C-605, must be installed at all private street intersections.

**Table 4.2**  
**Minimum Width Requirements for Private Streets**

ROAD WIDTH (TO BACK OF CURB, FT.)	PRIVATE STREET TRACT WIDTH (FT.)	PARKING
25	33	None allowed *
29	37	One side only *
35	43	Both sides

Notes: Refer to Section 4.2.3 for applications of these standards.

Refer to Section 4.2.7 for sidewalk requirements. The width shown assumes 4 ft. sidewalk on both sides. Tract width requirements with a 5 ft. sidewalk increase by 2 ft. to 35, 39 and 45 feet, respectively.

\* Refer to Fire Department Detail FD111 for Fire Lane signing and marking requirements.

**4.2.2.3 Cluster Developments with Private Shared Driveways**

Cluster developments with a private shared driveway must adhere to the configuration options shown in Figure 4-C and the requirements shown below:

**A. Design Standards**

- a. Private driveway specifications must be per City Detail C-214. Minimum width is 24'.
- b. Driveway entrance per MAG Detail 250. Additional sidewalk easement may be required.

**B. General Requirements**

- a. Solid waste collection will be picked up only on private or public streets in a designated area. For private street widths less than 29', an additional (off street) designated area will be required.

**C. Utility Requirements**

- a. Standard water, sewer and electric locations are shown on City Detail C-214.
- b. Separate easements or P.U.E.'s are required for water meters, fire hydrants, transformers, streetlights, utility pedestals, etc.
- c. All dry utilities must be joint trenched within the 24' P.U.E.
- d. Some type of private streetlights are to be provided.
- e. Water must be 6" minimum on a private drive.
- f. GPS coordinates must be provided for all bends in water and sewer service lines.

**D. Planning and Platting Requirements**

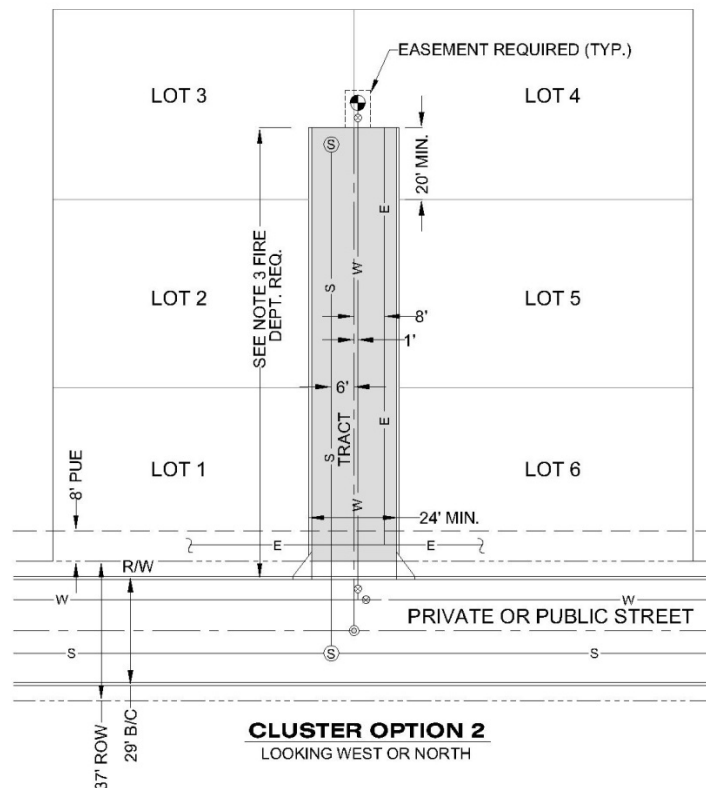
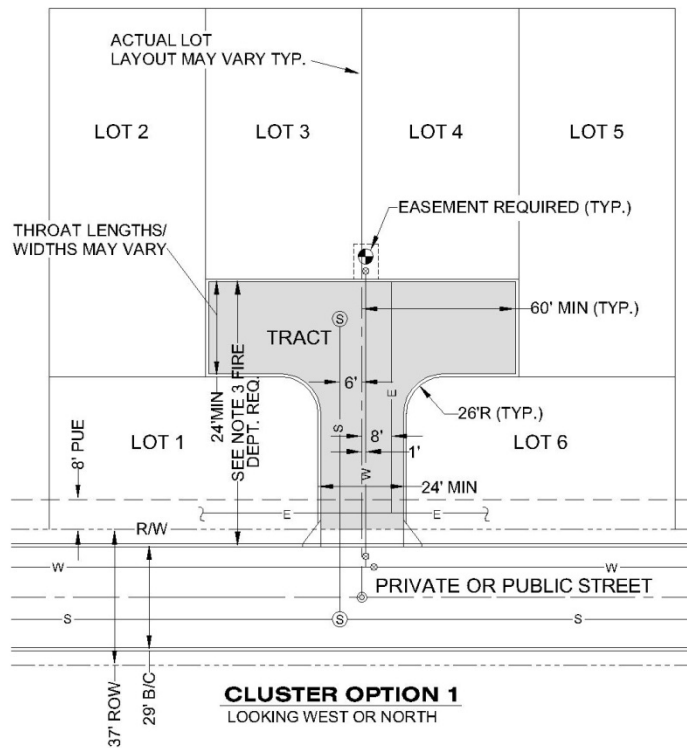
- a. The 6-pack cluster options shown are the standard approved lot configurations. Other configurations may be approved by the Public Works & Utilities Director or designee.
- b. Each private driveway must be designated as a tract and responsibility dedicated appropriately.
- c. Easements required over private driveway (tract) must be dedicated appropriately in this order:
  - i. Water & Sewer Easement (to City of Chandler).
  - ii. Public Utility Easement
  - iii. Cross Access Easement
  - iv. Drainage Easement

**E. Fire Department Requirements**

- a. No parking will be permitted on private driveway. Visitor parking must be provided in designated areas.
- b. See City Fire Department Detail FD-111 and/or FD-112 for fire lane signage and parking restrictions on a private street.
- c. Private driveway must have a turnaround (hammer head) as shown on Cluster Option 1 or when Cluster Option 2 depth exceeds 150'. This supersedes City Fire Department Detail FD-141 requirements.

(Intentionally left blank)

**Figure 4-C**  
**Cluster Configuration Options**





### 4.2.3 Parking

This section deals specifically with on-street parking on private residential streets.

It clarifies the requirements that will allow use of a 25-foot wide private road within developments, as specified in Table 4.2. The rules that follow do not apply to apartments, or developments similar to apartments, where all parking is already commonly shared. Exceptions to this rule may also be permitted in very large lot (greater than 90' lot frontage) subdivisions where circular or very long driveways can accommodate large number of visitors parking privately on the same lot.

A 25-foot wide road requires that 'No Parking' be permitted on both sides of the street. In such instances, all residential developments must have adequate visitor parking within a convenient distance of individual lots to ensure that drivers do not park on-street. This 'No Parking' requirement allows for safe access by emergency vehicles and provides for two-way circulating traffic.

The City Code Section 47-14 currently specifies that *"The minimum allowable width of the private streets will be determined by the City Engineer based on projected traffic volume and availability of off-street parking."* As a general rule, a minimum of 10 parking spaces or 0.25 spaces/unit, whichever is greater, will be required for on-site visitor parking before a 25-foot wide private road will be considered. Visitor parking spaces are defined as common-area spaces, and are in addition to the parking for individual units (i.e. driveway parking). These commonly shared parking spaces may be grouped together for convenience but must be evenly spaced throughout the site to minimize the walking distance to individual lots.

### 4.2.4 Intersections

#### 4.2.4.1 Allowable Intersection Types

Design types permitted for major intersections on arterial streets are as follows:

- a. Basic crossing with four legs.
- b. T-intersection with three legs.
- c. Roundabouts

No five- or six-leg intersections are permitted.

#### 4.2.4.2 Corner Radii

Curb return radii requirements are shown on Table 4.3. Deviations from this standard will require City staff approval.

**Table 4.3**  
**Typical Intersection Curb Return Radii**

TYPE OF INTERSECTION	TYPICAL RADII (FACE OF CURB, FT.)
Arterial-Arterial, Arterial-Collectors, and Industrial Roads	30
Arterial-Locals *, Collector-Collectors, and Collector-Locals	25
Local-Locals	20

\* For gated entries, refer to Table 4.5 for driveways.

**4.2.4.3 Sight Distance**

Corner sight distance requirements at intersections are given on City Details C-246 and C-247. An additional requirement from the Zoning Code, known as the "triangle area," is shown in Figure 4-D. There is an additional engineering requirement for traffic control device visibility noted on Figure 4-D.

No obstructions of any type over 18 inches high, including landscaping, are allowed within 1-foot of the back-of-curb.

Stopping sight distance is the minimum sight distance allowable for all intersection approaches. Minimum stopping sight distances are shown in Table 4.1 for flat terrain. Roadways on grade will increase or decrease these distances, and in such cases, references such as the American Association of State Highway Transportation Official's (AASHTO) policies and guidelines for roadway design should be consulted.

Three types of movements for traffic entering a major street from a minor side street or driveway result in three different sets of sight distance requirements:

- a. Right turns from the minor street onto the major street.
- b. Left turns from the minor street onto the major street.
- c. Left turns into the intersection or access point from the major street.

Sight-distance requirements for entering arterial or collector streets are shown on City Detail C-246. Heights of buildings, walls, landscaping, and other similar obstructions should be restricted within the sight triangles. Sight distance is measured from a driver's eye height of 3.5 feet to an approaching target 4.25 feet high.

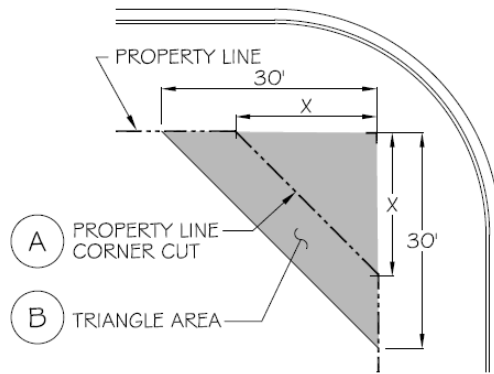
Along local or collector streets with residential frontage where motorists can expect frequent conflicts with vehicles entering or exiting driveways, a minimum sight distance of 200 feet is required, as illustrated in City Details C-247 and C-248. As explained above for arterial and collector streets, heights of obstructions should be restricted within the sight triangles to

provide a clear field of vision from a driver’s eye height of 3.5 feet to an approaching target 4.25 feet high.

**4.2.4.4 Corner Restrictions**

The City’s Municipal Code Chapter 48-10.2 (Public Works - Subdivision) specifies a range of triangular cutoffs for the corner property line at intersections. Additionally, Figure 4-D below requires that the 30’ x 30’ area be kept clear of visual obstructions between 2’ and 6’ in height.

**Figure 4-D  
Triangle Area**



NOTES:

- (A) X = 10' FOR ALLEYS  
15' FOR LOCAL-LOCAL INTERSECTIONS,  
20' FOR ALL OTHER INTERSECTIONS,  
PER MUNICIPAL CODE CHAPTER 48-10.2
- (B) GROUND COVER, FLOWERS, AND GRANITE LESS THAN 2' (MATURE) IN HEIGHT AND /OR TREES WITH BRANCHES NOT LESS THAN 6' ABOVE GROUND IN THIS AREA.  
TREES SHALL NOT BE SPACED LESS THAN 8' APART.  
PER MUNICIPAL CODE CHAPTER 35-2204

SEE STANDARD DETAIL NO. C-246, C-247 AND C-248 FOR SIGHT DISTANCE REQUIRED AT DRIVEWAYS AND INTERSECTIONS.

**4.2.5 Clearance to Obstructions**

Streetlight poles, utility poles, and similar obstructions are not allowed within 1-foot of a sidewalk. Streetlight poles are not allowed within 2.5 feet of the back-of-curb. Utility poles and similar obstructions are not allowed within 5.5 feet of the back-of-curb, but obstructions may be located as close as 2.5 feet from back of curb when adjacent to deceleration lanes, parking lanes, right turn lanes or bus bays. All dimensions above refer to face-of-pole.

### 4.2.6 Medians

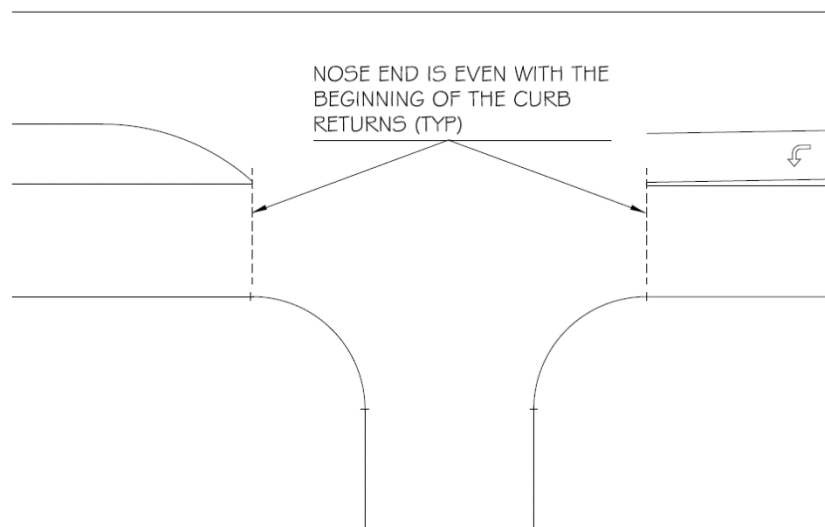
Raised medians must be installed on all new arterial streets complete with curbs, pavers and landscaping, unless otherwise specified. Flush medians may be installed on arterial reconstruction projects where flush medians currently exist, with approval of the Public Works & Utilities Director or his designee.

Median breaks must generally be constructed at one-eighth, one-quarter, and one-half mile spacing from major intersections. All other median breaks must be justified by a traffic study *and approved in writing by the City Transportation Engineer. Please refer to Section 6.4 for details on other access spacing.* Median breaks will not be allowed in medians of less than 14 feet in width.

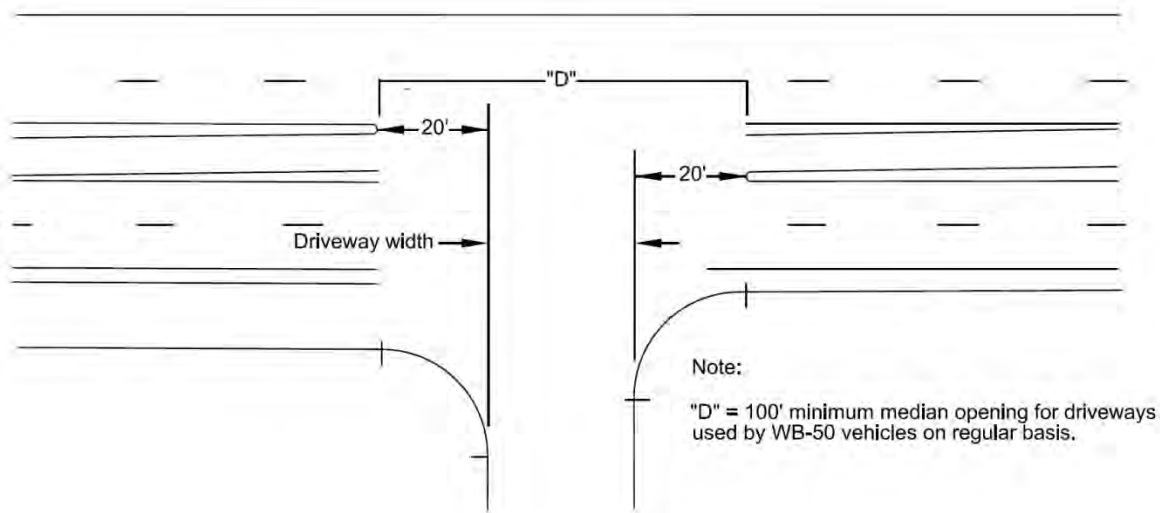
Raised median noses must be designed as shown in Figures 4-E and 4-F. Typical median designs are shown in City Details C-225, C-226, and C-227. Median terminations at midblock locations not at a driveway or intersection must be semi-circular.

When designing oversized raised medians that allow for future widening from four lanes to six lanes, the left turn bays must be constructed at their ultimate locations.

**Figure 4-E**  
**Typical Median Nose Location**



**Figure 4-F**  
**Median Nose at Driveway Entrance**



#### 4.2.7 Sidewalks

Sidewalks must be provided along all arterial, collector and local streets as shown on Typical Cross Section City Details C-203 – C-222. Typical minimum width is 6-foot for arterials and 5-foot for collectors and locals. In areas with high pedestrian volumes, wider sidewalks may be required. Construction must be per MAG Detail 230 and may be modified to 4 foot minimum provided that, per ADA, a 5-foot by 5-foot passing area is provided every 200 feet to allow wheelchairs to pass on all sidewalks. Driveways and other connecting sidewalks may be used to provide the passing area, as long as the cross-slope is less than 2%.

#### 4.2.8 Street Lights

Please refer to Chapter 6 – Streelight Design.

#### 4.2.9 Drainage

Valley gutters are not allowed to cross arterial streets under any circumstances. 6-foot wide gutters (per MAG Detail 240) are to be used where there is stop control for through traffic and 8-foot (mid-block) valley gutters (per City Detail C-233) are to be used where there is no stop control.

For inlet options and requirements, refer to Chapter 3 – Storm Drainage System Design.

Storm drains are normally installed whenever the 10-year design storm flows cannot be contained within the top-of-curbs. However, the installation of 7-inch vertical curb instead of the standard 6-inch vertical curb may eliminate the need for storm drains. The use of 7-inch vertical curb requires special approval of the Public Works & Utilities Director or his designee and may only be installed on short sections of street near the drainage inlets.

#### **4.2.10 Deceleration Lanes**

Left turn and right turn lanes must be provided on all approaches to major (arterial-arterial) intersections as shown in City Detail C-223. Left turn lanes must be provided on all median breaks, and right turn lanes must be provided where warranted by projected traffic demands (per Section 4.2.10.1).

Where turn lanes are constructed, length of storage lanes must be a minimum of 100 feet. Turn lane lengths at intersections for which traffic signals may be warranted must be designed to accommodate 15 to 20-year traffic demands with less than a 5-percent probability of overflow during peak flow periods. Design guidelines for deceleration lanes on arterial streets are presented in City Details C-224, C-225, C-226, C-227 and C-231. In most cases, it is preferable to provide more turn-lane storage rather than longer taper lengths.

Where the demand warrants and cross-sectional widths are available on both the intersecting streets, dual right-turn and/or left-turn lanes can be incorporated.

If additional right-of-way is required above the normal right-of-way requirement in order to construct a deceleration lane or the sidewalk associated with a deceleration lane, it is the developer's responsibility to provide it. Normally, the right-of-way required will extend a minimum of 4 feet back of the sidewalk.

##### **4.2.10.1 Right Turn Deceleration Lanes**

A right turn deceleration lane must be provided at cross streets and driveways when projected right turns into the site exceed 40 vehicles for a typical peak hour.

Where successive driveways are less than 400 feet apart (nearest edge to nearest edge), a continuous right turn lane rather than separate right turn lanes must be constructed. Where a driveway warranting provision of a right turn deceleration lane is located less than 450 feet in advance of an arterial cross street, a continuous right turn lane rather than separate right turn lanes must be constructed.

Driveways are not permitted within the taper itself. All driveways must be contained within the fully developed deceleration lane itself, including the curb returns. The design of a continuous right-turn deceleration lane should not continue through a full-access intersection or driveway entrance (median break).

The City Transportation Engineer on a case-by-case basis may waive the right turn deceleration lane requirement.

##### **4.2.10.2 Left Turn Deceleration Lanes**

Left turn deceleration lanes are required as specified in Section 4.2.10. On arterial streets without a median (roadways not yet upgraded to City standards), temporary widening must be constructed to accommodate a left turn lane and through lane redirection tapers as shown in City Detail C-229.

#### **4.2.11 Bus Bays**

##### **4.2.11.1 Placement of Bus Bays:**

- a. All bus bay locations must have prior written approval of the City's Transportation Engineer and must be consistent with the City's Transportation Master Plan.
- b. Bus bays will generally be placed at one-mile intervals along arterial streets with existing or planned bus routes, adjusted as necessary to ensure that boarding and de-boarding will be convenient for service to abutting land uses. Additional bus bays, if warranted, may be spaced at one-half-mile intervals, but in no case spaced less than one-quarter mile apart.
- c. Generally, bus bays should be installed only at signalized intersections.
- d. Bus bays should be located at the far side of street intersections (on departures from the intersection) and within 200 feet of signalized intersections.
- e. Bus bays should not be installed at mid-block locations.
- f. Bus bays may be integrated with right-turn deceleration lanes. The integrated design will provide a constant lane cross-slope with no valley gutter existing or constructed between the through travel lanes and the combination bus bay/ deceleration lane.
- g. Bus bays should be located at route transfer points and layover locations at the end of bus routes.
- h. Bus bays should be located at stops with high peak period passenger boardings, or at stops with a high proportion of wheelchair or bicycle boardings.
- i. Right-of-way impacts and utility relocations should be avoided or minimized when determining bus bay locations.
- j. Bus bay locations will be prioritized and programmed in the City's Capital Improvements Program based on the following criteria: average daily traffic volumes, street lane capacity, frequency of bus service and average number of passenger boardings.
- k. The City will require dedication of right-of-way from new developments along existing and planned transit routes for construction of bus bays and associated landing and shelter pads.

##### **4.2.11.2 Design and Construction of Bus Bays:**

- a. Bus bays must be constructed of concrete and designed in accordance with City Detail C-230 when not integrated with a deceleration lane and with C-231 when integrated with a deceleration lane.
- b. Bus bays should be incorporated into the design and construction of larger arterial street and intersection improvement projects to reduce costs.
- c. All bus bays should include a concrete pad of sufficient dimensions located behind the adjacent sidewalk to accommodate a passenger shelter, bench, trash receptacle and advertising/information kiosk.



#### **4.2.12 Bus Shelters**

- a. Advertising at bus stops located on arterial streets areas should be permitted to offset the costs of installing and maintaining passenger shelters and associated fixtures.
- b. Advertising revenues will be used to offset transit operating costs.
- c. All new passenger shelters should be lighted or located in proximity to an existing streetlight.
- d. Where irrigation is available, landscaping and shade trees should be provided in proximity to the shelter pad to increase shade to the passenger waiting area.
- e. The design of developer installed bus shelters and associated fixtures require prior written approval of the City Engineer before construction. Shelter ownership, long-term maintenance responsibilities, and replacement cost due to damage are primary considerations.
- f. All new bus stops must meet the accessibility requirements set forth under the Americans with Disabilities Act (ADA).
- g. For existing bus stops, any necessary upgrades to meet ADA requirements must occur with adjacent projects including mill and overlay, private development and CIP.
- h. Bus shelters should only be installed along streets served by a transit route.

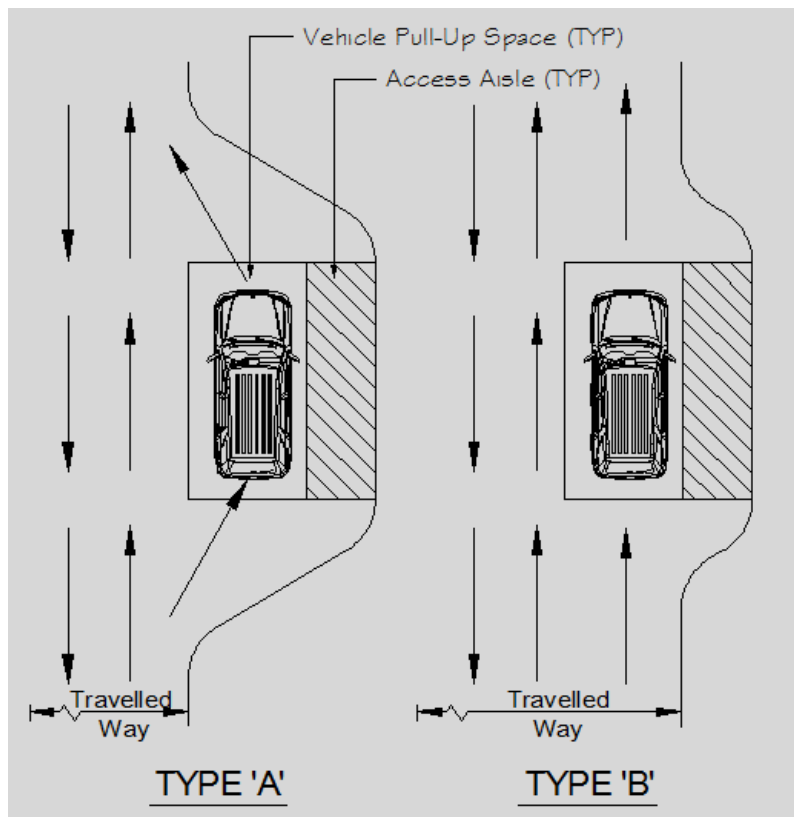
#### **4.2.13 Passenger Loading Zones (Autonomous Vehicles and Ride Sharing)**

This section deals specifically with passenger loading zones intended for on-site passenger drop-off and pick-up scenarios, but may also be applied to public rights-of-way with the approval of the City Transportation Engineer. Please reference City Zoning Code Section 35-1808 and City Building Code for other requirements or allowances.

Generally, there are two types of passenger loading zone scenarios provided to accommodate traffic flow, travelled way width restrictions and other site or design considerations. For Type 'A' both the vehicle pull-up space and access aisle are outside the travelled way, while Type 'B' only the access aisle, as shown on Figure 4-G.

(Intentionally left blank)

**Figure 4-G**  
**Passenger Loading Zone Types**



Further guidelines are listed below and presented on City Detail C-261. This section provides general guidance on a variety of curbing and accessible ramp options, some of which are shown, that may be tailored to meet the needs of each site.

- a. Access aisles must be marked as shown and must connect to an accessible route to the building.
- b. Access aisles must be at the same level as the vehicle pull-up space they serve and must not overlap the travelled way.
- c. Access aisles and pull-up spaces must have slopes no steeper than 2% in any direction.
- d. Passenger loading zones must be signed as shown.
- e. Bollards or other types of barriers may be used adjacent to loading zones as long as minimum ADA widths are provided.
- f. All single loading zones must be accessible. For multiple and continuous loading zones, one accessible loading zone must be provided every 100 feet.

### **4.3**      **PAVEMENT STRUCTURAL DESIGN**

#### **4.3.1**    **Flexible Pavement**

City Details C-203 through C-222 for street cross-sections also include notes referring to the appropriate City Standard Detail for asphaltic pavement thickness and the appropriate MAG Standards for material requirements.

#### **4.3.2**    **Rigid Pavement**

Rigid pavements, such as Portland cement concrete, are generally not used for City streets. If rigid pavements are used, each design must be approved by the Public Works & Utilities Director or his designee on an individual basis.

#### **4.3.3**    **Decorative Pavement**

The use of interlocking paving blocks in roadways and medians must be approved by the Public Works & Utilities Director or his designee. When approved, they must be installed in accordance with MAG Detail 225 using pattern and stone per City List of Approved Products. In addition, a minimum of 25 paving blocks of the type installed must be deposited free of charge at the City's maintenance yard for future City maintenance operations.

The use of decorative concrete may be approved optionally by the Public Works & Utilities Director or his designee.

#### **4.3.4**    **Miscellaneous Pavement Standards**

For cases where the full depth of base course cannot be constructed due to insufficient cover over existing facilities, the City reserves the authority to approve equivalent alternate designs if justified.

The minimum pavement cross-sectional requirement for temporary turnarounds, which are constructed at project phase lines, is 6 inches of aggregate base course over 6 inches of subgrade; see MAG Standard Specifications Sections 301, 310 and 702. If the temporary turnaround is constructed at a project boundary, a surface course of 2 inches of asphaltic concrete is required in addition to the base and subgrade noted above; see MAG Standard Specifications Sections 321 and 710, without lime.

Temporary pavement cross-sections must consist of 2 inches of asphaltic concrete over 6 inches of aggregate base course over 6 inches of subgrade, see the same MAG Standard Specifications sections noted above.

### **4.4**      **TRAFFIC CONTROL DEVICES**

#### **4.4.1**    **Signing & Striping**

Yield signs may be placed at intersections with no acceleration lane where the safe entry speed is greater than 10 MPH. All yield sign use and placement must be by the approval of the Public Works & Utilities Director or his designee.

All signs must be manufactured of “ASTM D-4956-04 Type IV Sheeting” which will be attached to the standard signage aluminum plates. Sign imaging must be in compliance with the

reflective sheeting manufactures matched component system. Sign imaging must consist of an acrylic based electrocut film or silk screened using inks (depending on the quantity of signage) with standard highway colors.

Barricades, MAG Detail 130 Type "B," are required at all dead end streets and street stub-outs, except cul-de-sacs. An end of road marker (18"x18"), MUTCD OM4-3 (retro-reflective red diamond panel), spaced on 5-foot center along the barricade are required. A turn-around area is also required (see Section 4.6.3 of this chapter).

Deceleration and right-turn lanes are signed and striped in accordance with City Detail C-620.

Speed limit signs, MUTCD R2-1, are installed on all local and collector streets at approximately 100 to 200 feet from arterial intersections. Speed limit sign locations on arterial streets are shown in City Detail C-621. The posted speed limit for local streets is 25 mph. The posted speed limit for collector and arterial streets is determined by the City Transportation Engineer, based upon individual circumstances. No parking signs, MUTCD R8-3a, are 24" x 24" on arterials and 18" x 18" on all other streets.

Arterial and collector signage and striping standards are shown on City Details C-600 through C-623. Reflective markers are required on all arterial streets. On collector streets reflective markers are required only along street sections with unusual conditions, such as: intersection approaches where through lanes converge after the end of a median or left turn lane. Where conditions require use of reflective markers, the markers are to be installed from a point 500 feet or more in advance of the conditions to a point 500 feet or more beyond the conditions. Pavement markers must be prismatic reflectors only.

Typical median signage is shown on City Detail C-600.

All improvements made within 175 feet of a railroad crossing must be in accordance with City Detail C-624. If the improvements are taking place at a railroad crossing within one of the city's Quiet Zones, the City Transportation Engineer must be notified immediately to ensure the proposed improvements will maintain compliance with the Quiet Zone. A raised median, in accordance with Figure 4-H, must be installed at all railroad improvement projects, where feasible.

Developments are required to supply and install sign posts at all intersections for new stop signs and street name signs. Public street name signs will be installed by the City after payment of the prevailing fees by the developer. This is the only case where the City will perform any work associated with a development. Private street name signs are the responsibility of the developer.

Signal conduit, 4-inch diameter schedule 40 PVC with detectable mule tape and with ADOT No. 7 pull boxes, is installed at all legs of arterial intersections where median breaks are present, including arterial-arterial intersections. See ADOT Standard Detail T.S. 1-4 for No. 7 pullbox.

Traffic signal interconnect conduit and fiber are required on all arterial roads, must be per the requirements in Chapter 5 – Traffic Signal Design.

#### **4.4.2 Half Road Standards**

Generally, developments are required to construct all full roads internal to the development, and half-roads bordering the development.

A half-road must be a minimum of 24 feet from face-of-curb to the edge of pavement.

For arterial and collector half-roads with a raised median, the half-road must include the full raised median, and one through lane in the opposing direction. Arterials with flush medians and two-way-left-turn lanes should be treated in the same manner.

All typical road infrastructure requirements (such as street lights, landscaping, irrigation, sidewalk, etc.) will apply to half-roads. There may be other additional improvements, as deemed necessary by the Public Works & Utilities Director or his designee.

#### **4.4.3 On-Street Parking with Bulb-Outs**

The following requirements will apply for all on-street parking using bulb-outs. See City Detail C-215 for the typical street cross-section. The standard allows for both the normal crown and valley gutter option; however, additional drainage considerations will be necessary when not using a valley gutter.

Parallel parking spaces must be 8' x 22'. Angle parking spaces must be 9' x 19' (measured perpendicular to face-of-curb) at a standard angle of 60 degrees. See City Detail C-260 for further details and requirements.

Figure 4-I and 4-J illustrate the placement of trees, street lights, utility boxes, etc. See Fire Department Standard Details for further requirements, and also Downtown Streetscape Guidelines for additional recommendations.

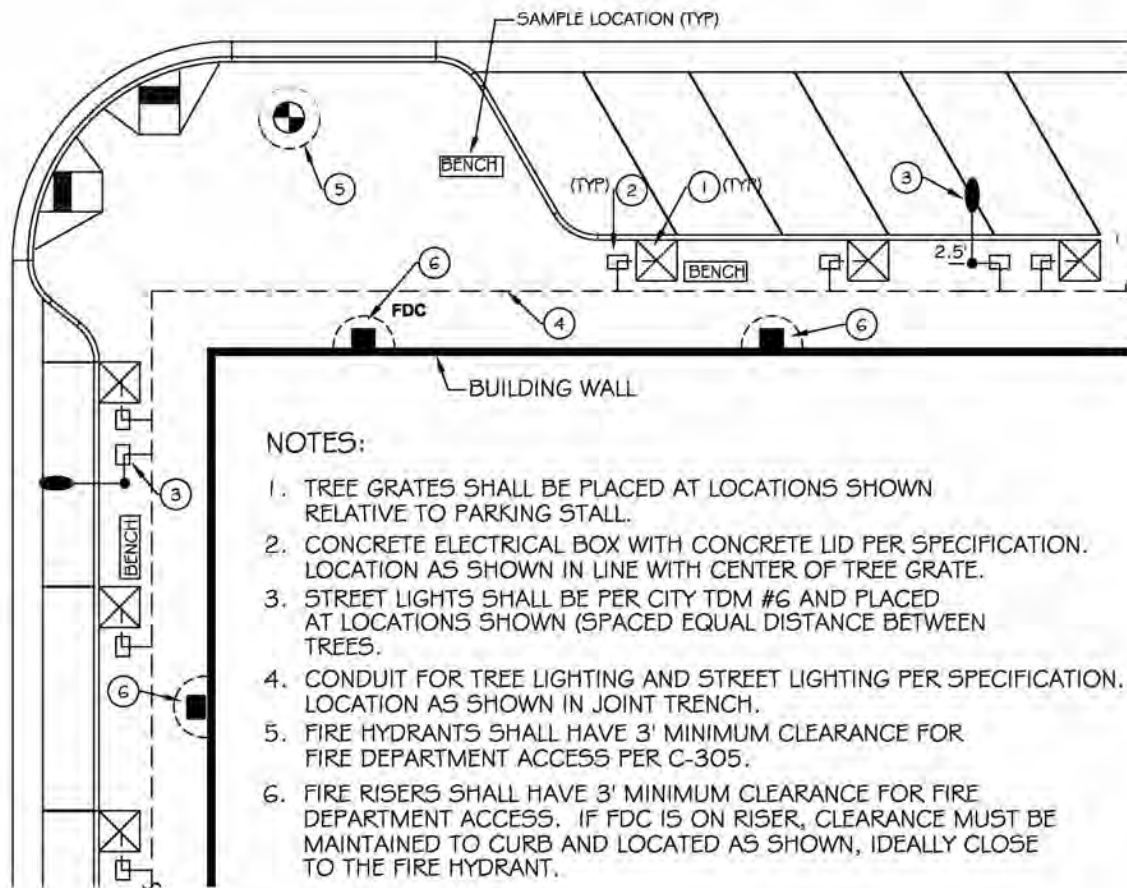
#### 4.4.4 Accessible Parking Spaces

Per the Proposed Rights-of-way Access Guidelines (PROWAG) R309, accessible parking spaces are required whenever “marked” on-street parking spaces are provided on a City block. The number of required spaces is 4% of the total number of spaces on that block, with a minimum of one per block.

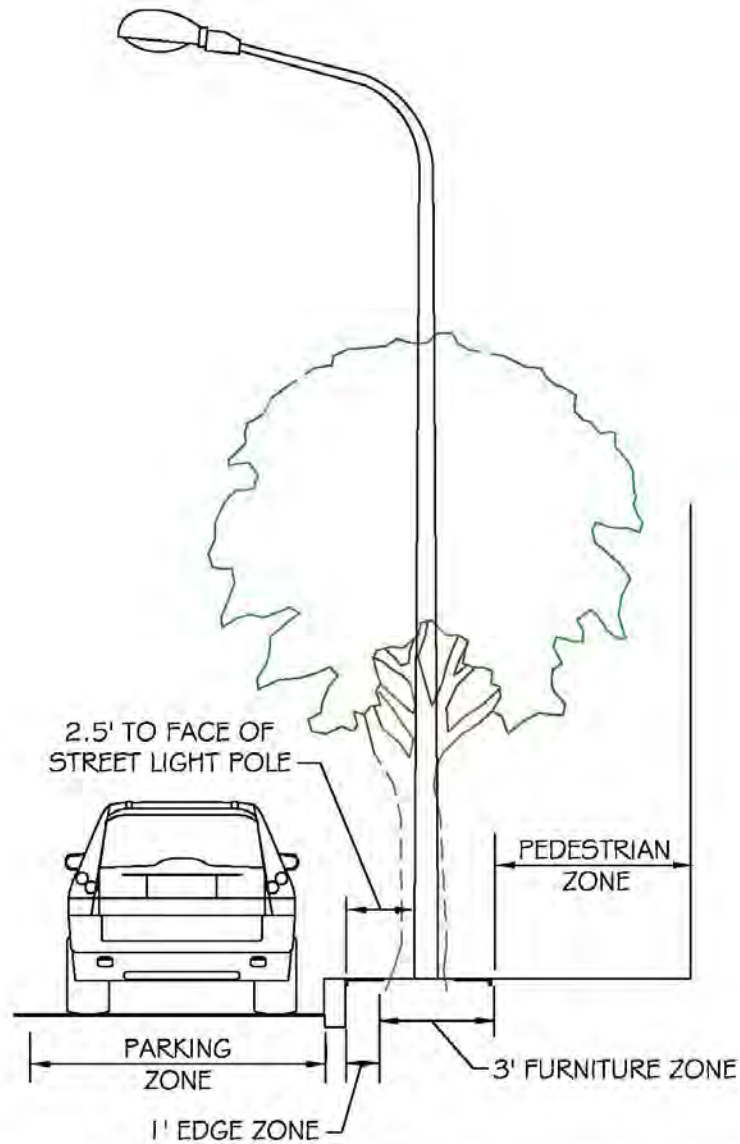
PROWAG requires access aisles only in specific situations where sufficient sidewalk width is provided (see PROWAG R309). For parallel parking, an available sidewalk width of 14’ or more will require an access aisle. When used, the accessible spaces must conform to City Detail C-260, Page 2.

For existing designated on-street parking spaces, any necessary upgrades to meet ADA requirements must occur with adjacent projects including mill and overlay, private development and CIP.

**Figure 4-H**  
**Street Furniture and Utility Locations**



**Figure 4-1**  
**Typical On-Street Parking Cross Section**



ZONE	NOTES
PARKING	PARALLEL OR ANGLE PARKING.
EDGE	NO ABOVE GROUND OBSTRUCTIONS ALLOWED.
FURNITURE	SIGN POSTS, STREET LIGHTS, TREES, BENCHES, BIKE RACKS, ETC.
PEDESTRIAN	TYPICALLY 6' WIDE OR MORE, BUT NO LESS THAN 4' TO MEET ADA. ENTIRE ZONE SHALL BE WITHIN RIGHT-OF-WAY OR PUBLIC EASEMENT.



#### **4.4.5 Traffic Signals**

If new development requires the relocation of existing traffic signals, the developer is responsible for the redesign and all costs associated with reconstruction. The redesign must be submitted to the City for approval prior to relocation.

Traffic signals will be installed upon satisfaction of warrants contained in the current edition of the Manual on Uniform Traffic Control Devices. The warrants must be factored to exclude right turn movements. Warrants must be used in conjunction with professional judgment based on experience and consideration of related factors.

Traffic signals should be located where timings of successive signals may be coordinated to allow progression in both directions of movement. Signal spacing must be on consistent intervals along an arterial to allow two-way progression. Two-way progression is not mandatory but is highly desirable.

Traffic signal locations between major intersections should be kept to a maximum of three installations, ordinarily at the half- and quarter-mile points. Slight shifts from quarter-mile signal spacing locations are permissible depending upon a review of storage length requirements and traffic progression impacts. (Shifts of up to 50 feet in either direction from the quarter-mile spacing point do not require analysis.) Upon satisfaction of warrants for installation of a traffic signal, a semi-actuated traffic signal may be considered at an intermediate intersection or major driveway located at other than quarter-mile spacing. City approval or denial will be based on review of a traffic impact assessment report evaluating effects of the proposed median opening and signal on provision of sufficient taper and storage lengths for turn lanes, and on progression of through traffic along the arterial street.

#### **4.4.6 Traffic Calming**

Traffic calming devices are required along all newly constructed local streets with single-family residential frontage on straight or nearly straight segments over 600 feet in length. Typical traffic calming devices are speed humps (City Detail C-234), traffic circles, raised crosswalks, chicanes, and chokers. Traffic calming devices should be spaced about 300 to 500 feet apart and should generally be at least 200 feet away from a stop-controlled intersection or right-angle turn in the roadway. Contact Traffic Engineering at 480-782-3454 to suggest and obtain approval of traffic calming options.

### **4.5 TRAFFIC IMPACT STUDIES**

The City of Chandler has a Scope of Work for Traffic Impact Studies, which is available on [www.chandleraz.gov](http://www.chandleraz.gov) or by calling (480) 782-3454. Per the Scope of Work, a Traffic Impact Study will be required:

- a. If the development land use and intensity meets or exceeds 100 trips during the peak hour;

- b. If the project intensifies the land use and/or density, or modifies the occupancy of an existing facility;
- c. Or as directed by the City Transportation Engineer.

The cost of the traffic analysis and the cost of implementing the recommendation will be the responsibility of the developer.

## **4.6 ACCESS MANAGEMENT**

### **4.6.1 Access Control**

These guidelines are to be used in the planning, design and approval of access to the arterial street system and emergency access requirements. The arterial street system is as defined in the latest approved version of the City of Chandler Transportation Master Plan and generally consists of all section-line roadways within the City of Chandler.

The primary function of the arterial street system is to provide mobility for intra-city and inter-city travel. Access to abutting land is secondary to providing a high level of mobility and safety.

General access to the arterial network is provided by intersections with collector and local roadways and by major and minor driveways to developments. The spacing of access intersections will vary between the arterial functional classes, according to the level of land access, which may be allowed.

New single family residences are not allowed direct access to arterial streets.

### **4.6.2 Location and Number of Access Points**

Arterial street access to any parcel with less than 200 feet of arterial street frontage will be limited to one two-way driveway or one pair of one-way driveways on that frontage. Access points should conform to Section 4.6.4 concerning spacing between access points. Additional driveways may be permitted if the following conditions are met:

- d. Driveway two-way volume exceeds 1,500 vehicles per day with build-out of site.
- e. Traffic volumes exiting the site under build-out conditions exceed capacity of stop-sign controlled intersections during peak hour of street or peak hour of site.
- f. Traffic impact analysis determines that two driveways are required to safely and efficiently accommodate demand.

Developers of large sites or abutting sites along arterial streets should seek to consolidate major driveways at the appropriate intermediate intersection/median break points. Such consolidation may assist in meeting traffic signal warrants and in providing for acceptable signal progression on the through street.

Residential developments should have at least one access per 200 single-family residential units, 1 access per 350 multi-family units, or 1 access per 350 mobile homes. Developers

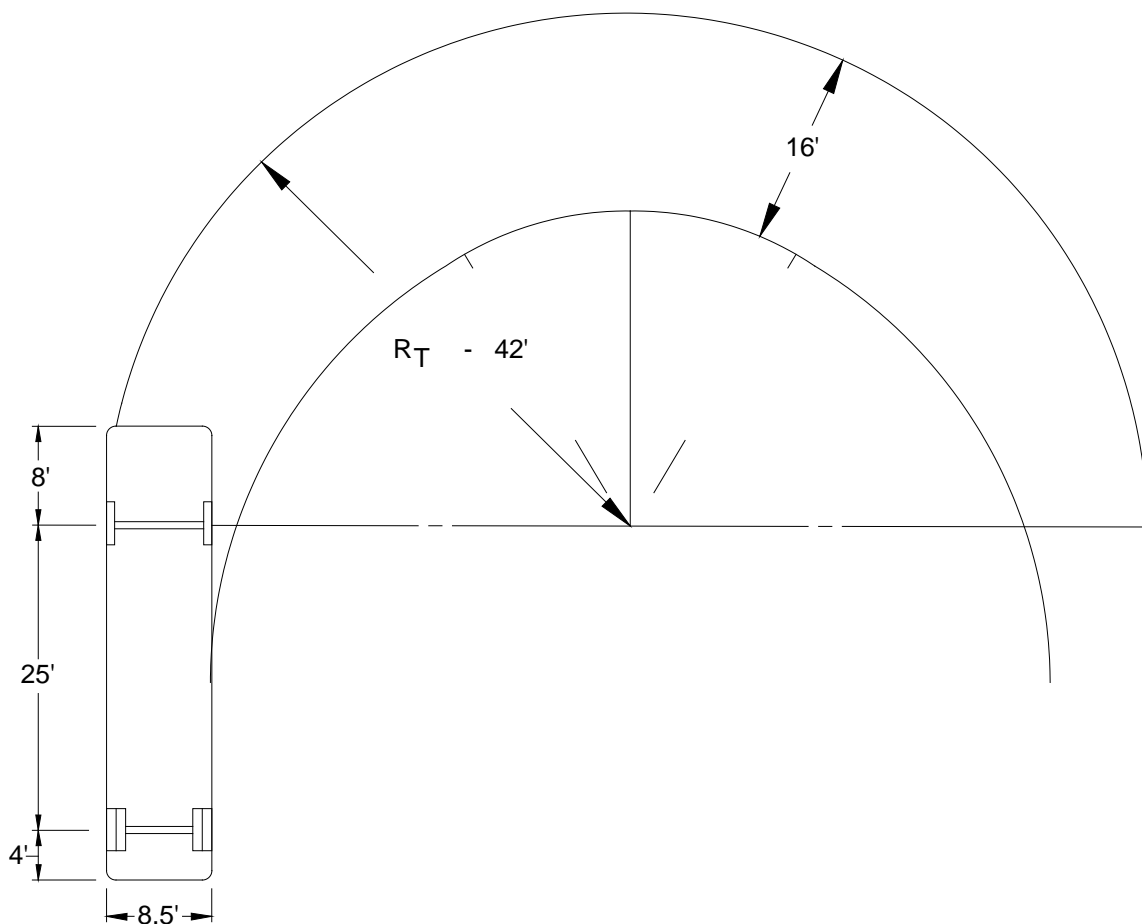
proposing fewer accesses for their project must provide a traffic study showing acceptable levels of service.

### 4.6.3 Emergency Access Requirements

Minimum turning radii requirements for temporary turnarounds and access roads, including on-site parking and driving areas for commercial, industrial or multi-family residential sites, are given in Figure 4-K. When constructing a temporary turnaround, the configuration, such as a hammerhead or bulb, is flexible.

The Fire Department requires all developments and all sub-areas within a development to be served by two independent access routes placed a distance apart equal to not less than half the length of the maximum overall diagonal dimension of the lot or area served, measured in a straight line between access points. One of these routes may be designed or controlled for use by emergency vehicles only.

**Figure 4-J**  
**Minimum Turning Radii for Temporary Turn-Around**  
**and On-Site Roadways Providing Emergency Vehicle Access**



If an access lane or parking lot has a dead end that exceeds 150', a turnaround per FD 141 will be required.

26' drive lanes are required for aerial apparatus rescue adjacent to all building 30' in height or higher.

All gated emergency only access points must be set off the roadway by a minimum of 55' to allow for the safe distance for the Fire Department to pull off the roadway to open the access gate or barrier. If the gate swing is out or towards the roadway, then the distance of the gate panel must be included in the gate set back

#### **4.6.4 Driveway Spacing and Storage**

Figure 4-L shows recommended minimum spacing between driveways and adjacent intersections, driveways and median ends along arterial and collector streets. Location of major driveways (serving a major generator, with no restriction of turning movements) is controlled by distances needed for provision of left turn storage lanes and approach tapers. Major driveways on opposite sides of the street should be aligned to accommodate cross travel and to avoid conflicts between left-turning vehicles. Where a flush median design is used (two-way left turn lane), minor driveways on opposite sides of the street should either be aligned or offset a minimum of 200 feet along arterial streets and 100 feet along collector streets. All driveways, including minor driveways restricted to right turn movements, should be spaced at least 100 feet apart along arterial streets and 50 feet apart along collector streets.

Intermediate intersections with collector and local roadways and major driveways should be limited to a maximum of five per mile. Intermediate intersections may be located a minimum of one-eighth mile from the nearest major intersection. Desirable intersection spacing is at quarter-mile intervals. Intersections should be located at consistent intervals to allow for two-way traffic-signal progression.

Direct land access should be controlled, and new residential developments must not front an arterial street. Right-in, right-out access points may be allowed based on travel demand.

##### **4.6.4.1 Driveway Storage**

Along an access drive from which left turns may be made onto an arterial street, cross-aisles must be located at least 80 feet from the arterial street (right-of-way line to nearest edge of driveway). A larger setback may be required where traffic impact studies indicate greater than a five-percent probability of driveway blockage during the peak hour of a typical weekday.

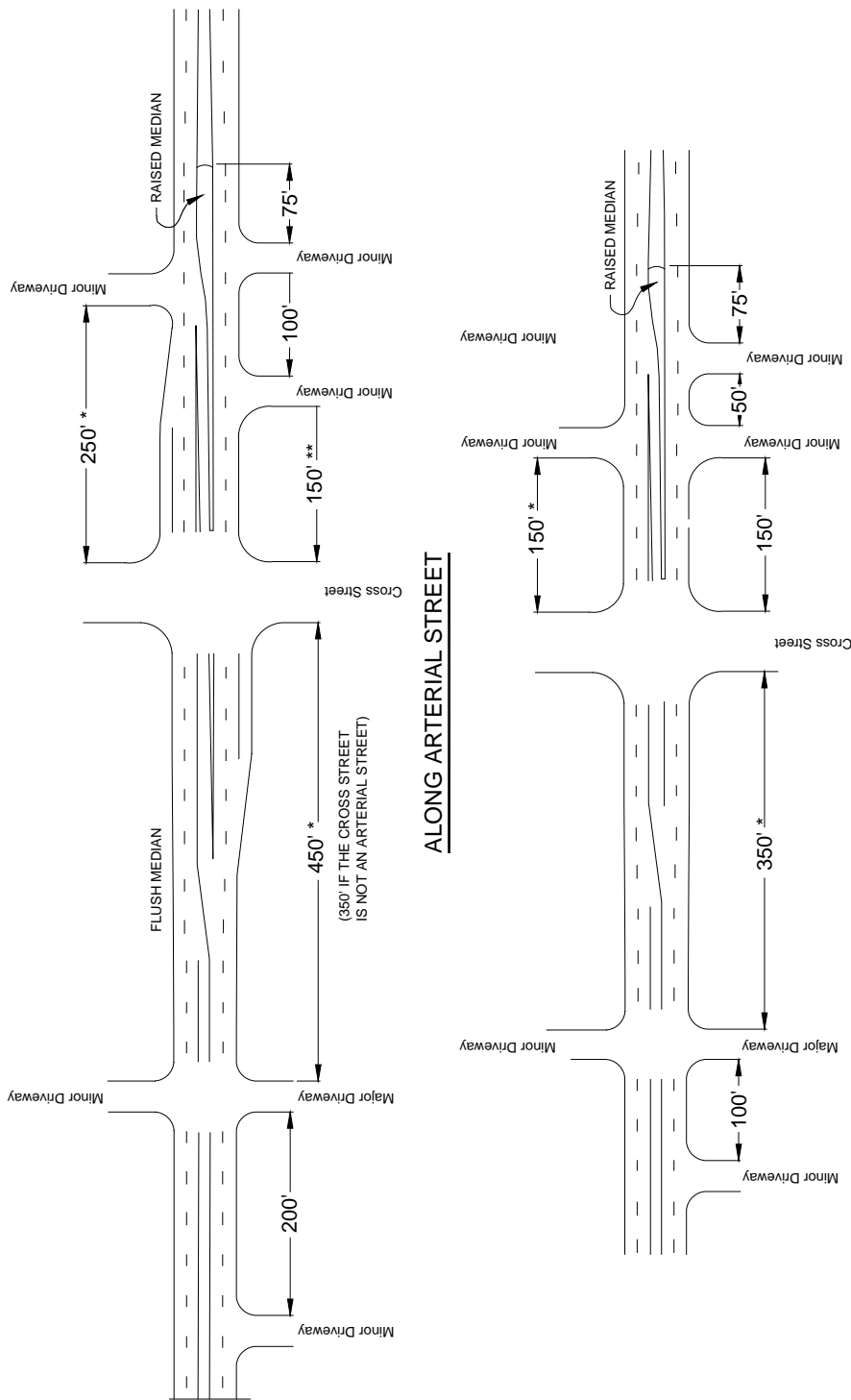
##### **4.6.4.2 Intersection Clearance**

Minimum corner clearances at public intersections are shown in Figure 4-L. Where narrow lot widths do not permit the enforcement of the minimum clearances, an absolute minimum corner clearance of 50 feet may be used. On arterial streets, left turns into and out of such a driveway will not be permitted.

On-site geometrics are especially critical at drive-through facilities such as banks, fast-food restaurants and car washes. Sufficient stacking space should be provided to prevent blockage of arterial street access and egress. Where information about peak arrival rates and service times is not available, the preferred storage length in advance of a menu board or service bay is 150 feet (100 feet minimum).

(Intentionally left blank)

**Figure 4-K**  
**Driveway Spacing Along Arterials and Collector Streets**



\* — Corner clearance may be reduced to a minimum of 100' on approach to an intersection with no potential for traffic signal installation for minor driveways restricted to right turn movements only.

\*\* — Corner clearance should be increased to a minimum of 250' where driveway traffic volume warrants a right turn lane on departure from intersection.

#### 4.6.5 Driveway Widths

All driveways onto arterial streets must be constructed with curb returns, except for utility maintenance driveways with two trips per day or less. Recommended dimensions are shown in Table 4.4.

**Table 4.4**  
**Driveway Widths (to-face-of-curb)**

WIDTH	MULTI-FAMILY RESIDENTIAL	COMMERCIAL	INDUSTRIAL
Minimum Width (1-way)	16'	16'	16'
Minimum Width (2-way)	24'	24'	24'
Maximum Width	30'	40'	40'

Where high pedestrian traffic is expected (e.g., in the central business district or close to a high school, auditorium or library), a maximum width of 30 feet is desirable. Where large truck movements are expected on a regular basis (5 or more trips per day), the corner radius and driveway lane width should be designed to accommodate the truck turning path without encroachment on the arterial street parallel traffic lane or the driveway opposing traffic lane.

#### 4.6.6 Curb Return Radii

Unless otherwise noted, Table 4.5 specifies the typical corner radii for the various land uses.

**Table 4.5**  
**Driveway Curb Return Radii (to-face-of-curb)**

RADII	RESIDENTIAL	COMMERCIAL	INDUSTRIAL
Minimum Radius	20'	20'	25'
Maximum Radius	20'	25'	30'
Maximum Width	30'	40'	40'

### 4.7 ADA UPGRADE REQUIREMENTS

#### 4.7.1 ADA Curb Ramps

Curb Ramps must be constructed or upgraded to achieve ADA compliance when constructing mill and overlay projects, capital improvement projects and private development projects per the procedures below. There may be limitations, which make it technically infeasible for an intersection (or single curb ramp) to achieve full compliance within the scope of a project. These limitations should be noted and the locations added to the City's ADA Transition Plan.



#### **4.7.1.1 Standard Curb Ramps and Detectable Warning System Placement**

Truncated domes are the standard design requirement for detectable warnings to denote the boundary between the sidewalk and street for people with visual disabilities. The placement of the truncated domes is dependent on the type of curb ramp to be used. Directional curb ramps per City Details C-257 and C-258 should be used at street intersections (or driveways) and truncated domes must be aligned per City Detail C-249. Aligning the domes to the opposing ramp enhances the ability for safely crossing the street.

Truncated domes are to be placed at the back-of-curb (BOC) on straight curb lines, or when within the corner radius return one corner of the truncated dome insert must be placed at 2" from BOC (alleviating maintenance concerns of narrow strips of concrete that typically crack and dislodge).

There may be limitations that will not allow the use of our standard directional curb ramp (C-258) or in-line ramp (C-257). Other curb ramp designs or modifications to our standards may be approved by the City Engineer; however, every curb ramp must be made compliant with ADA requirements.

#### **4.7.1.2 Asphalt Overlay Projects**

For Mill and Overlay Projects (and hot-in-place recycling), existing curb ramps within the extents and adjacent to the project will be evaluated for current ADA compliance and City directional curb ramp standards. All non-compliant (and diagonal) ramps are required to be replaced to City directional curb ramp standards. If the project is less than 200' away from the curb line extension of an adjacent intersection, then the project is required to make ADA upgrades at these intersections.

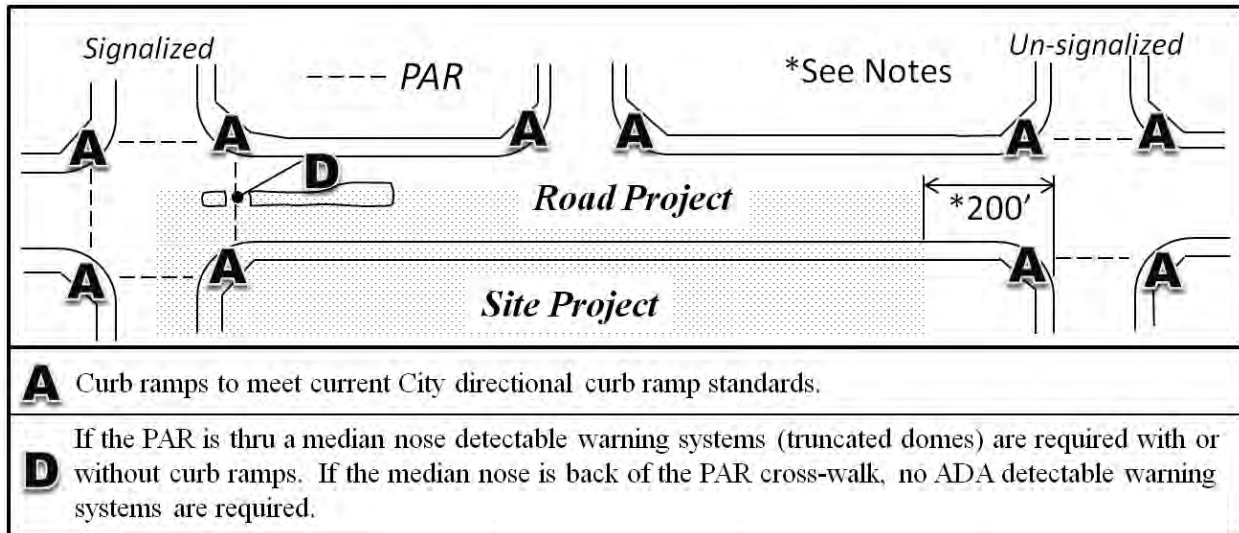
#### **4.7.1.3 Capital Improvement Projects**

For City Capital Improvement Projects (CIP), curb ramps will be replaced based on the following requirements and as shown in Figure 4-M:

- a. Pedestrian Access Routes (PAR) must be determined and shown on the plans for the project including connections to curb ramps across the street.
- b. Existing curb ramps within the extents and adjacent to the project will be evaluated for current ADA compliance and City directional curb ramp standards. All non-compliant (and diagonal) ramps are required to be replaced to City standards.
- c. ADA compliance criteria meets ADA slopes and landing area requirements.
- d. For arterial street construct/reconstruction projects, all curb ramps, sidewalks, and driveways are required to be upgraded to meet current ADA standards, as shown. For collector and local street construction/reconstruction projects, the same requirements as for mill and overlay will apply.
- e. City site development projects are required to make ADA upgrades to an adjacent intersection when constructing new sidewalks, and curb ramps, or replacing

existing driveways less than 200’ from any intersection, as shown below, or otherwise required by the City Engineer.

**Figure 4-L**  
**Capital Improvement Project**  
**Curb Ramp Replacement Requirements**

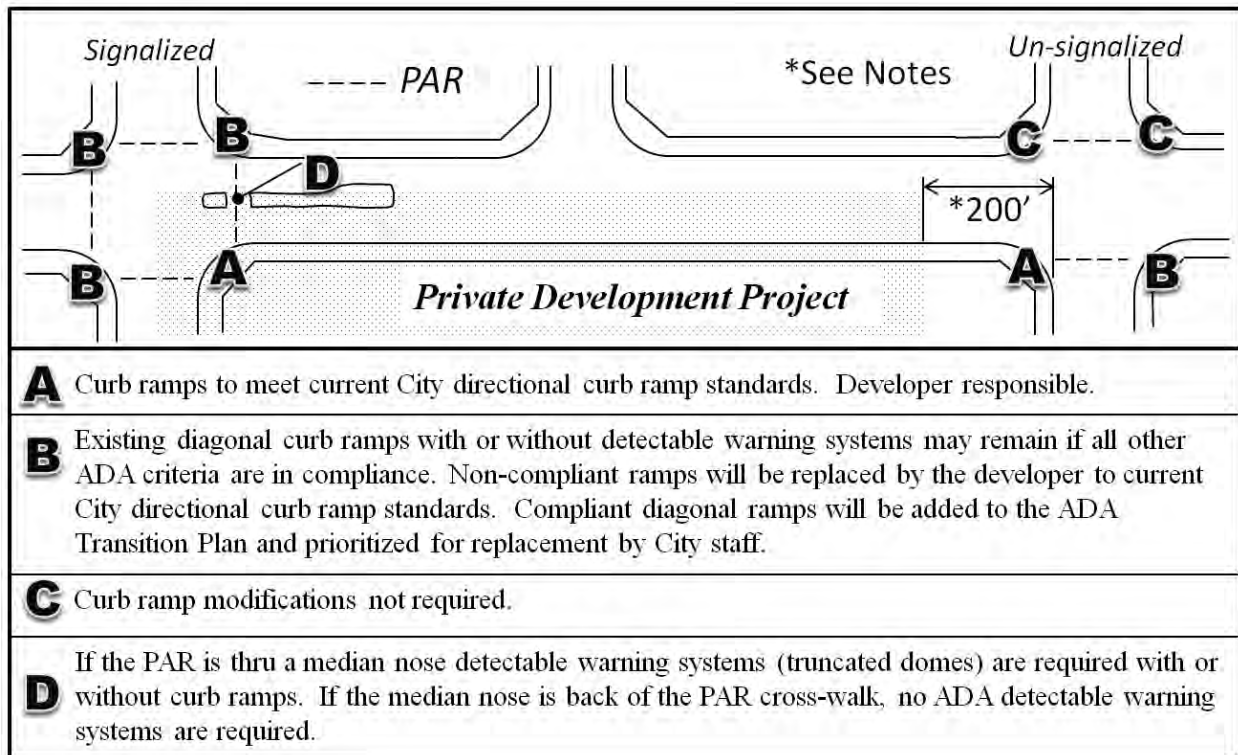


#### 4.7.1.4 Private Development Projects

For Private Development Projects, curb ramps will be replaced based on the following requirements and as shown in Figure 4-N:

- a. Pedestrian Access Routes (PAR) must be determined and shown on both the on-site and off-site plans for the project including connections to curb ramps across the street.
- b. Existing curb ramps within the extents and adjacent to the project will be evaluated for current ADA compliance and City directional curb ramp standards. Non-compliant curb ramps are required to be replaced as shown.
- c. ADA compliance criteria meets ADA slopes and landing area requirements.
- d. Site development projects are required to make ADA upgrades to an adjacent intersection when constructing new sidewalks, and curb ramps, or replacing existing driveways less than 200’ from any intersection, as shown below, or otherwise required by the City Engineer.

**Figure 4-M**  
**Private Development Project**  
**Curb Ramp Replacement Requirements**



**4.7.2 ADA Sidewalks**

Sidewalks are intended to be constructed or upgraded to achieve compliance within mill and overlay projects, capital improvement projects and private development projects per the procedures below. There may be limitations, which make it technically infeasible for segments of sidewalk to achieve full accessibility within the scope of a project. Those limitations will be noted and those segments will remain on the ADA Transition Plan.

**A. New construction sidewalks (and sidewalks crossing driveways):**

Must be built with a cross slope of 1.5% to ensure tolerance does not fall outside of ADA requirements.

**B. Upgrades with CIP or private development projects – Cross slope:**

Existing sidewalks adjacent to private development or major (over \$250K) capital improvement projects that exceed the ADA 2.0% maximum cross slope along the Pedestrian Access Route (PAR) must be replaced to meet current standards.

**C. Upgrades with CIP or private development projects – Tripping hazards:**

Existing sidewalks adjacent to private development or major (over \$250K ) capital improvement projects that contain tripping hazards or obstructions along the Pedestrian Access Route (PAR) must be brought to current ADA compliance.

#### **D. General upgrades to existing sidewalks:**

Must be based on evaluation and rectification procedures below:

- a. Typical upgrades to existing sidewalks that exceed a 2.0% cross slope:
  - i. If the average slope is over 2.0% and less than 3% for any length, sidewalk will be replaced when a private development or capital improvement project occurs or complete reconstruction of street or sidewalk occurs.
  - ii. If the average slope is 3.0% and less than 4.0% for a distance of 10 feet or more, sidewalk will be documented in the ADA Transition Plan and scheduled for replacement in the normal mill and overlay program. Locations less than 10 feet will be replaced per item i) above.
  - iii. If the average slope is 4.0% and less than 5.0% for a distance of 10 feet or more, sidewalk will be documented in the ADA Transition Plan and scheduled for replacement within next five fiscal years. Locations less than 10 feet will be replaced per item ii) above.
  - iv. If the slope of any segment of sidewalk is 5.0% or greater the location will be documented in the ADA Transition Plan and scheduled for replacement within next two fiscal years.
  
- b. Typical upgrades to existing sidewalks that contain uneven surfaces:
  - i. If a difference in elevation is between ¼-inch and ½-inch remediation will occur with a private development or major capital roadway improvement project, or when complete reconstruction of street or sidewalk occurs.
  - ii. If a difference in elevation is between ½-inch and 1-inch, location will be documented in the ADA Transition Plan and scheduled for remediation within next ten fiscal years.
  - iii. If the change in level is greater than 1-inch, location will be documented in the ADA Transition Plan and scheduled for remediation as soon as practical.
  
- c. Typical upgrades to driveways will follow the same procedures outlined above for the sidewalk segment crossing the driveway.

#### **4.8 PLAN SUBMISSION REQUIREMENTS**

All off-site construction plans, except landscaping, must be prepared and signed by a professional engineer who is qualified and registered by the State of Arizona to practice in the particular field of competency required by the type of improvements. Landscaping plans must be prepared by a landscape architect that is qualified and registered by the State of Arizona.

Plans must be submitted on 24" x 36" sheets. The plans must be drawn to an engineering scale. Architectural scales are not allowed, including landscaping plans.

There are no specific engineering scale requirements, but 1-inch equal to 20 feet and 1-inch equal to 40 feet are the preferred horizontal scales. The vertical scale, when profile is required, need not differ from the horizontal scale by a precise factor of 10. Water, sewer, and paving plans for non-arterial streets may all be shown on the same plan sheets if a horizontal scale no smaller than 1-inch equal to 40 feet is used. Arterial street plans must always be prepared at a horizontal scale of 1-inch equal to 20 feet. Separate plan sheets must be shown for:

- a. paving plans
- b. signs, pavement markings (with streetlights as a background layer)
- c. street lighting
- d. landscaping, and
- e. water and sewer plans
- f. traffic signal plans (with striping as a background layer)

Requirements for street lighting are given in Chapter 6 of this manual.

All landscaping within arterial street rights-of-way must be reviewed and approved by the City Landscape Maintenance & Design Coordinator. All plant material must comply with the Arizona Department of Water Resources approved "Low-Water" list. Refer to Chapter 8 of the manual for additional information.

All elevations shown on the plans must be referenced to a benchmark on the City datum unless otherwise approved by the City Engineer.

Additional plan requirements are given in the pavement and street light plans checklists. The checklists are to be included with paving and/or street light plans with each submittal for City review. The most current versions of the City's general, paving, and street light plan notes, and pavement and street light checklists, are available at the Development Services Counter, 215 East Buffalo Street.

(Intentionally left blank)

## Chapter 5 - Traffic Signal Design

### 5.1 GENERAL INFORMATION

The purpose of this chapter is to assist the developers and their consultants in the planning and design of traffic signals within the City of Chandler’s (City) right of way. The guidelines contained within this chapter are intended for use by Professional Engineers and Design Professionals with a background in the underlying fundamentals in Traffic Engineering. This chapter does not provide the answers for all situations involving the design of traffic signals. It does, however, provide the tools for solving most of them. It is expected that those designing traffic signals within the City bring to each project the skills and abilities to provide the optimum traffic control device to the public. This may include any new signal design concepts that result in a higher quality of traffic control and/or cost effectiveness. Deviations from these standards must be approved by the City Transportation Engineer prior to submittal for review and approval.

Any questions regarding the signal design should be addressed to:

City Transportation Engineer  
City of Chandler  
215 East Buffalo Street  
Mail Stop 406  
P.O. Box 4008  
Chandler, AZ 85224-4008  
Phone: (480) 782-3470

### 5.2 DEVELOPER’S CHECKLIST

A checklist has been developed to assist developers/consultants in the design of traffic signals in the City. This checklist is not intended to be all inclusive, but a helpful guide in the design of traffic signals.

The following items should be researched for inclusion into the traffic signal design plans or in the development of the plans:

- a. Contact Blue Stake (602-263-1100) to determine existing utilities in the area.
- b. Survey the intersection for the development of a base plan. This survey should be performed after the intersection has been Blue Staked by the utility companies. In addition to the utilities, the survey should locate all existing roadway features within the intersection and 200 feet up each leg of the intersection. This includes face-of-curb, back-of-sidewalk, curb inlets, pavement markings, signs, walls and any landscaping that may affect the location of traffic signal equipment.
- c. Conduct a field visit of the intersection to verify the survey.
- d. Obtain maps from the utility companies and roadway as-builts from the City to supplement the survey.



- e. Contact the electric service company Salt River Project (SRP) or Arizona Public Service (APS) to determine a power source location for the signal.
- f. Contact City of Chandler Telecommunication and Utility Franchise (TUF) staff [tuf@chandleraz.gov](mailto:tuf@chandleraz.gov) to obtain service address, include the service address in the pole/cabinet schedule of the plans.
- g. Obtain existing and/or future right-of-way in the area and identify on the plans.

The developer/consultant should anticipate a minimum of two (2) submittals to the City prior to approval of the traffic signal.

Plan approvals are limited to 6 months after the approval date and may be renewed for another 6 months if no changes to the existing or future intersection configuration have occurred.

### **5.3 ELECTRICAL SERVICES**

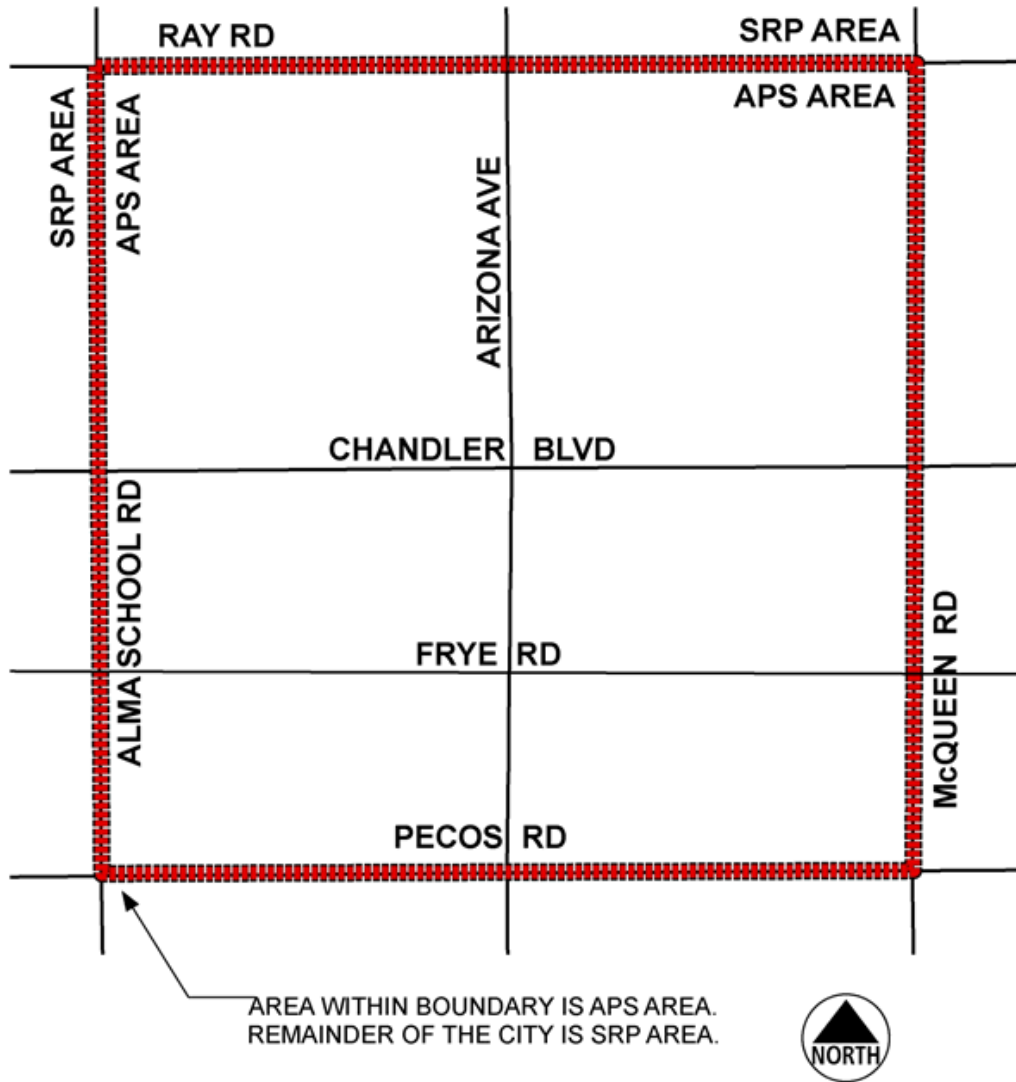
The City is served by two electrical service companies: Salt River Project (SRP) and Arizona Public Service (APS). All areas of the City are served by SRP except for the APS area shown on the map below. The signal Design Professional should contact the appropriate utility company early in the design process so that a “point of service” location can be identified.

All new traffic signals must use metered power service.

(Intentionally left blank)



**Figure 5-A**  
**Electrical Services**  
**Boundary Map**



NOTE:  
PLANS FOR STREET LIGHTS ON ARIZONA AVENUE BETWEEN CHANDLER  
BLVD AND FRYE RD SHALL BE SUBJECT TO SPECIAL APPROVAL.

#### 5.4 PLAN DEVELOPMENT

Traffic signal plans submitted for approval by the City should be prepared using the Computer Aided Design and Drafting (CADD) software AutoCAD® and comply with the City's CADD Standards as indicated below.

The City uses a coversheet and two plan sheets for the design of traffic signals:

- a. **Coversheet** (see Unified Development Manual, Section 8) - contains the project title, vicinity map and the general notes. Contact the City Development Services for format and content requirements.
- b. **Sheet 1** is used for the signal layout and contains a legend and the notes to the contractor as follows:
  - i. Signal Plan View
  - ii. Min Scale 1" = 20'
  - iii. Legend
  - iv. Pull Box Schedule
  - v. IISNS Details
  - vi. Construction Notes
  - vii. General Notes
  - viii. Phasing Diagram
  - ix. Cabinet Corner Inset/Details
- c. **Sheet 2** contains the pole and cabinet schedule, conductor schedule, phasing schedule and wiring diagrams as follows:
  - i. Conductor Schedule (Table 5.1)
  - ii. Traffic Signal Meter Pedestal (Detail C-721)
  - iii. Installation of I.M.S.A. Signal Cabinets (Detail C-722)
  - iv. Cabinet and Pole Schedule (Figure 5-D)
  - v. Terminal Wiring Details for Signals (Detail C-722)

All symbols used in the design of traffic signals must conform to ADOT standards. Some of these are summarized in Figures. 5-B and 5-C.

The Design Professional must refer and use the City Supplements and *Approved Products List* (APL) for the traffic signals.

AutoCAD® has the ability to place design information on several different layers in a file. This allows the separation of different design elements onto separate layers. The following is a recommended layering structure for the design of traffic signals:

**SHEET 1** (Plan View)

**Layer 1 (name – Title)** must be reserved for the border, title block, and legend.

**Layer 2 (name – Ex. Roadway)** must be reserved for the existing roadway configuration including curbs, sidewalks, striping, signing and edge of pavements

**Layer 3 (name – Utilities)** must be reserved for any existing signals, including pull boxes and conduit specifically used for traffic signal and communication cables.

**Layer 5 (name – New Signal)** must be reserved for all new signal and communication equipment as part of the signal design. Any general notes must be included on this layer.

**Layer 6 (name – Striping)** must be used for any striping or signing changes to be added in conjunction with the signal design.

**Layer 7 (name – Construction)** must be reserved for any roadway improvements needed in conjunction with signal installation.

**Layer 8 (name – Future)** must be reserved for any future improvements to the roadway, traffic signal, etc.

#### **SHEET 2** (Schedules and Diagrams)

**Layer 1 (name – Title)** must be reserved for the border and title block.
































**Layer 2 (name – Schedules)** must be reserved for the pole and cabinet, conductor and phase schedules.

**Layer 3 (name – Diagrams)** must be reserved for the wiring diagrams.

The Developer/Consultant must submit electronic files to the City when plans are submitted for their approval signature. Approval of the design plans is contingent upon conformance to the above design formats.

(Intentionally left blank)

**Figure 5-B  
Plan Symbols (Part One)**

<u>Proposed</u>	<u>Existing</u>	
		No. 5 Pull Box
		No. 5 Pull Box w/ Extension
		No. 7 Pull Box
		No. 7 Pull Box w/ Extension
		No. 9 Pull Box
		Signal Luminaire on Pole
		Power Pole
		Control Cabinet
		Load Center Cabinet
		Railroad Cabinet
		Traffic Signal Pole
		Guy Anchor
		Conduit Run
		Luminaire on Mast Arm
		Luminaire on Pole w/ Mast Arm
		Preemption On Mast arm

**Figure 5-C  
Plan Symbols (Part Two)**

Proposed	Existing	
		Pole with Mast Arm and Traffic Signal
		Pole with Mast Arms for a Luminaire and Traffic Signal
		Pole with Mast Arms for a Luminaire and Traffic Signal with Video Detection
		Traffic Signal Head
		Traffic Signal Head w/ Directional Arrow
FYA	FYA	Traffic Signal Head w/ Flashing Yellow Arrow
		Pedestrian Signal Head
		Closed Circuit Television Camera
		Video Detection Camera
		Pedestrian Push Button w/ Sign on Pole
		Signal Pole Number
		Conduit Run Number
		Gas Line
		Overhead Telephone Line
		Burried Telephone Line
		Cable Television Line
		Water Line
		Storm Drain
		Sanitary Sewer
		Overhead Electric
		Underground Electric
		Fiber Optic

**Table 5.1  
Conductor Schedule**

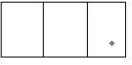
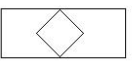
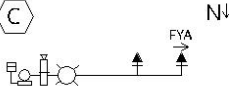
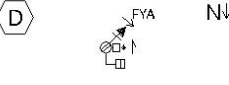
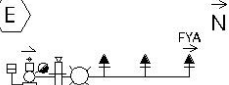
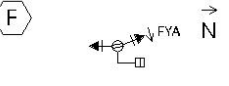
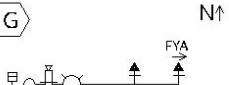


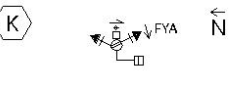
AWG	Conduit Run No.	1	2	3	4	5	6	7	8	9	10	11	12	13	14	15	16	17	18	19	20	21	22	
	Conduit Size	See Section 5.7 for Conduit Sizes																						
#14 AWG Solid 20 Conductor 20-1 I.M.S.A Signal Cables see notes 2&4	Pole C			1						1														
	Pole D			1						1														
	Pole E			1										1	1					1		1		
	Pole F			1										1		1				1		1		
	Pole G			1														1		1		1		
	Pole H			1															1	1		1		
	Pole J			1				1																
	Pole K			1		1																		
Per Manufacturer	Video Detection #2																							
	Video Detection #4																							
	Video Detection #6																							
	Video Detection #8																							
#6 AWG see note 1 black=hot white=neutral green=equip ground	Service120/240V ●		3																					
	Signal Cabinet 120V		2																				2	
Street Lighting 120V	#10 AWG (Red)			1			1	1		1			1	1			1		1		1			
	Common (White)			1			1	1		1			1	1			1		1		1			
Street Name Sign Lighting 120V	#10 AWG (Brown)			1			1	1		1			1	1			1		1		1			
	Common (White)			1			1	1		1			1	1			1		1		1			
#8 AWG see note 1	Conduit Bond (Green)	1	1	1	1	1	1	1		1	1	1	1	1			1	1	1		1	1		
Fire Detail Cable	Fire Preempt 1						1																	
	Fire Preempt 2							1		1														
	Fire Preempt 3												1	1						1		1		
	Fire Preempt 4																1		1		1			
See Note 3	Inter Connect																							
	CCTV Camera																							

● - Installed by SRP

**Conductor Notes:**

- (1) Minimum Number of Conductors Required (Non-I.M.S.A. Type)
- (2) Minimum Number of Cables Required (Including I.M.S.A. Types)
- (3) Twelve-Port Gator Patch
- (4) #14 AWG Solid, 5-Conductor from Signal Pole to the Inside Mast Arm Signal Heads  
#14 AWG Solid, 7-Conductor from Signal Pole to the Outside Mast Arm Signal Heads

**Figure 5-D  
Cabinet and Pole Schedule**

CABINETS						ASSEMBLY NOTES	LOCATION		
CABINET	TYPE	EQUIPMENT							
	METER PAD	SEE APPROVED PRODUCTS LIST SEE NOTE 6				PEC SHALL FACE NORTH ELECTRIC SERVICE ADDRESS: _____ _____ INSTALL CONCRETE PAD PER PER ADOT DETAIL T.S. 3-6	STATION AND OFFSET		
	IV	SEE APPROVED PRODUCTS LIST				INSTALL 4' SQUARE X 4" CONCRETE WORK PAD IN FRONT OF FOUNDATION WITH 8" TOE IN FRONT	STATION AND OFFSET		
POLES			MAST ARMS		SIGNAL ASSEMBLIES		PED. DET. SIGN	NOTES	LOCATION
ORIENTATION PLAN	TYPE	SIG	LUM	MTG	FACE				
	Q	35'	12'	2-II 1-V	2-F 1-M/H		1,3,4,5,7	STATION AND OFFSET	
	A 10'			1-IV 1-V	1-FYA 1-M/H	R10-4b	2,7	STATION AND OFFSET	
	R	55'	20'	3-II 1-V	1-FYA 2-F 1-M/H	R10-4b	1,2,3,4,5,7,8	STATION AND OFFSET	
	A 10'			1-VI 1-V	2-F 1-M/H		7	STATION AND OFFSET	
	Q	35'	12'	2-II 1-V	2-F 1-M/H		1,3,4,5,7	STATION AND OFFSET	
	A 10'			1-IV 1-V	1-FYA 1-M/H	R10-4b	2,7	STATION AND OFFSET	
	R	55'	20'	3-II 1-V	1-FYA 2-F 1-M/H		1,3,4,5,7	STATION AND OFFSET	
	A 10'			1-VI 1-V	2-F 1-M/H	R10-4b	2,7	STATION AND OFFSET	

**NOTES:**

1. PREEMPTION DETECTOR (ON MAST ARM) PER APPROVED PRODUCTS LIST.
2. TYPE I PEDESTRIAN PUSH BUTTON PER ADOT DETAIL T.S. 11-1.
3. LED LUMINAIRE, TYPE III, MEDIUM CUTOFF, 120 VOLT.
4. INTERNALLY ILLUMINATED STREET NAME SIGN PER CITY DETAIL C-606.
5. VIDEO DETECTION SYSTEM PER APPROVED PRODUCTS LIST.
6. NETWORK SWITCH PER APPROVED PRODUCTS LIST.
7. LED TYPE PEDESTRIAN TRAFFIC SIGNAL HEAD WITH COUNTDOWN TIMER.
8. CCTV SYSTEM PER APPROVED PRODUCTS LIST.



PRIOR TO ORDERING, ALL TRAFFIC EQUIPMENT SHALL BE SUBMITTED FOR APPROVAL R10-4b



**5.5 SIGNAL POLES**

**5.5.1 Signal Pole Types**

The Design Professional must use the City Details for signal poles, mast arms and foundations. Traffic Signal Tenon layouts are shown in Figures 5-F and 5-G.

**Table 5.2  
Tenon Schedule**

POLE TYPE	ARM LENGTH	NO. OF TENONS
K, R	45', 50', 55'	3
J, Q	35', 40'	3
J, Q	25', 30'	2
E, F	15', 20'	1

**5.5.2 Pole and Pushbutton Placement**

The City typically requires one pole for each corner of the intersection. Where site condition dictates, two poles may be used. One pole must be a type 'A' pole (or type 'G' pole depending on street lighting needs), while the other must be a 'J' 'K' or 'Q' 'R' depending on mast arm length and whether or not a luminaire is included on the pole.

Typical two pole placement layout is shown in City Detail C-720. The desirable pole location is within 5 feet from crosswalk line and 10 feet from face-of-curb. A maximum of 10 feet from crosswalk line and 20 feet from face-of-curb is allowed with the approval of the City Engineer or designee.

**5.6 PULL BOXES**

The City uses three sizes of pull boxes, No. 5, No. 7, and No. 9. The pull boxes must meet the requirements of City of Chandler ADOT’s Standards and Specifications. See City Detail C-103 for the typical City of Chandler fiber optic vault details.

The No. 5 pull box is placed adjacent to the electrical “point of service” location as agreed to by the utility company.

The No. 7 pull box is placed on all corners of the intersection, using a No. 7 with extension in front of the traffic signal cabinet. It is generally placed behind the sidewalk at the center of the radius. If no sidewalk or curbing exists or is planned with the signal installation, then the pull box should be placed as close as possible to the ultimate location.

The No. 9 vaults must be installed at all arterial/arterial intersections, proposed and future splice locations (as determined by the City’s Outside Plant Fiber Specialist) as well as end of project conditions. ADOT standard No. 7 pull boxes with extension, must be installed at no more than ¼-mile intervals to help pull through the cable. All pull boxes containing City

owned fiber optic cable must be No. 7 with the 24-inch extension (total depth of 36") or No. 9, as determined by the City's Outside Plant Fiber Specialist.

Figure 5-E provides typical locations for pull boxes, meter pedestal, and controller.

## **5.7**      **CONDUITS AND CONDUCTORS**

### **5.7.1**     **Conduit**

The City uses the following sizes of conduits for the traffic signal cables.

- a. One 2.5-inch conduit must be used between the point of service and the meter pedestal.
- b. One 2-inch conduit must be used between the meter pedestal and the traffic signal cabinet foundation.
- c. One 2-inch conduit must be used between the meter pedestal and the No. 7 pull box to service streetlights and Illuminated Street Name Signs.
- d. One 2-inch conduit must be used between the City owned fiber No. 9 vault into the cabinet foundation.
- e. One 3-inch conduit must be used to connect the pull box and the signal pole foundation at each corner.
- f. One 4-inch conduit must be used between the No. 7 pull boxes and is also used for any conduit run underneath the travelled way.
- g. Two 4-inch conduits must be used between the No. 7 with extension pull box and the traffic signal cabinet foundation.

See Figure 5-E for pull box and conduit locations. All conduits entering the controller foundation must be oriented per City Detail C-723 Controller Foundation Conduit Layout Detail. All conduit runs must be straight when possible.

Communication conduit must be comprised of four 2-inch conduits, one black and the other three must be grey color. All conduits must enter the pull boxes using 45-degree sweeps with no less than a 36-inch sweep radius. All empty and occupied conduits must include No. 12 AWG tracer wire and 2500# mule tape. Install warning tape "Caution: Buried Fiber Optic cable" along the conduit alignment approximately 12 inches below the finished grade. See City Detail C-104 for the typical City of Chandler fiber optic trench profile detail.

Communication conduit must be installed at a depth no less than 48 inches. Every effort must be made to minimize variations in the conduit profile (i.e. bends, vertical & horizontal shifts, etc.). No more than 360-degree in total bends and no more than two 45-degree sweeps must be used between pull boxes.

A 2-inch conduit must be installed directly into the cabinet foundation exclusively for the communication cable. This 2-inch conduit must run between the controller foundation and the communication vault.

### 5.7.2 Conductors

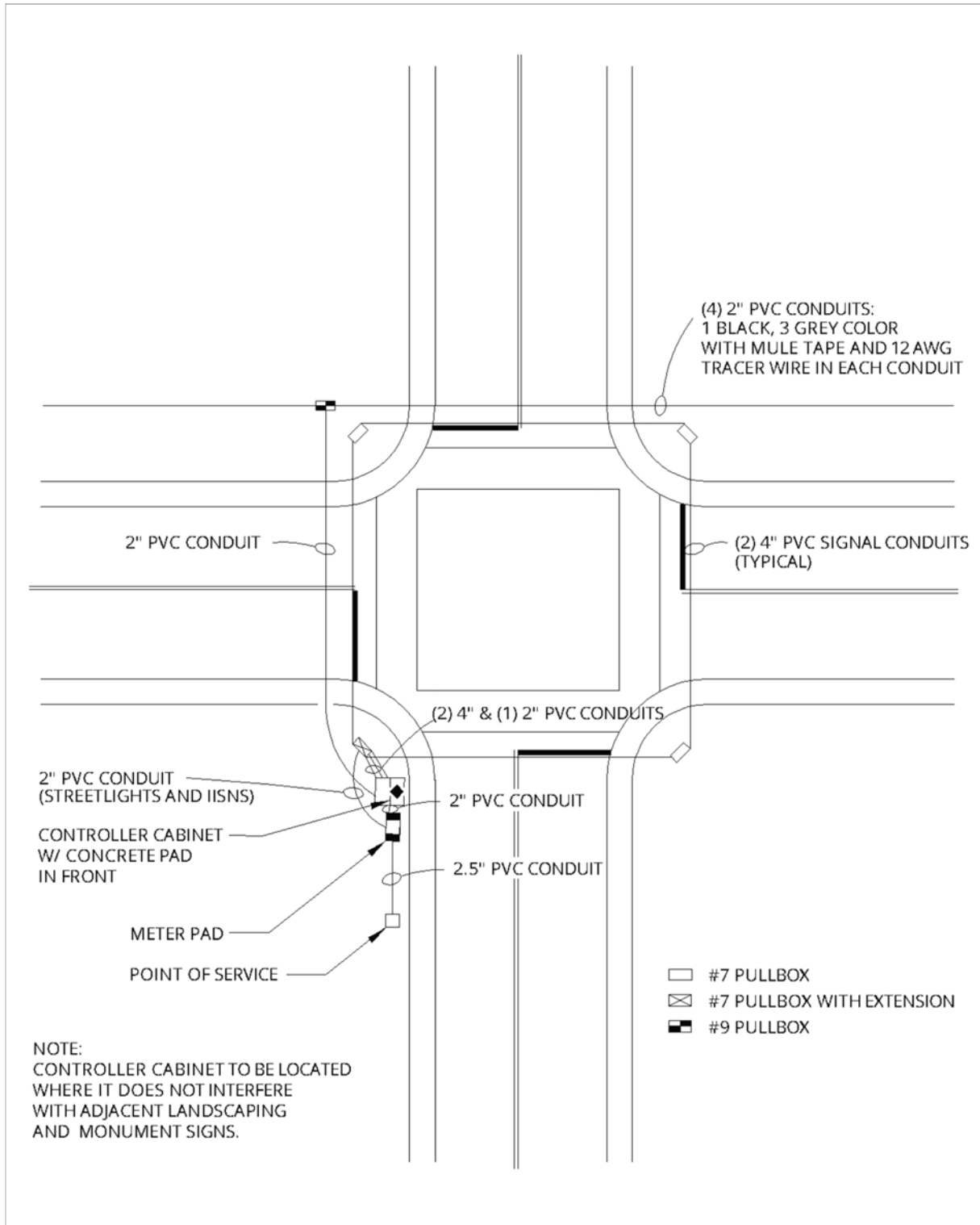
The City uses standard International Municipal Signal Association (IMSA) conductor cables for the traffic signal wiring. The following describes the type and use of conductors:

- a. No. 6 American Wire Gauge (AWG) solid or stranded, is used between the power supply and the cabinet.
- b. IMSA 20-1 signal cable, No. 14 AWG solid 20-conductor is used between the cabinet and each pole.
- c. No. 14 AWG, solid, 5-conductor AWG is used from signal pole to inside mast arm head.
- d. No. 14 AWG solid, 7-conductor is used from signal pole to outside mast arm head.
- e. No. 10 AWG solid or stranded, is used for the internally illuminated street name signs (IISNS) and the Luminaire.
- f. No. 8 AWG solid or stranded, green is used for grounding in all conduit runs.

In addition, a red Streetlight Conductor and brown Street Name Sign conductor must be in all runs and both conductors must have their own neutral. Conductors must be fused in the No. 7 pull box.

(Intentionally left blank)

**Figure 5-E**  
**Pull Box and Conduit Locations**



### 5.7.3 Communication Cables

The communication cable must be fiber optic cable only. Communication cable must be 144 strands, as determined by the City’s Outside Plant Fiber Specialist, with 12 fibers per buffer tube, single mode, fiber optic cable meeting the specifications listed in Table 5.3.

The fiber optic communication cable must run continuous for the complete extent of the project limits. Full splicing of the fiber optic communication cable mid-project will not be allowed. Any construction requiring the relocation or replacement of twisted-pair copper must be replaced with fiber optic cables. All infrastructure must be constructed “fiber friendly”. Any construction requiring the relocation or replacement of existing fiber-optic cable must be done so for the full length of all impacted existing fiber optic cables from end-to-end. Any fiber optic cables replaced must be brought up to current City standards.

All splicing must be done in No. 9 splice vaults or otherwise determined by the City Outside Plant Fiber Specialist, utilizing appropriately sized City approved splicing enclosures. Additional splicing locations may be required within the City boundaries that are outside of the immediate project vicinity. DEVELOPERS MUST COORDINATE ALL SPLICING WORK WITH THE CITY OUTSIDE PLANT FIBER SPECIALIST AT LEAST 4 WEEKS IN ADVANCE BY SENDING AN EMAIL TO [ospfiber@chandleraz.gov](mailto:ospfiber@chandleraz.gov). Any splicing locations listed on the plans may change by the time of project execution. Exact splicing locations and splicing diagrams will be provided by the City’s Outside Plant Fiber Specialist.

Gator patch (12-port) must be installed from the traffic signal cabinet to the pull box or vault. The gator patch must run continuous and unspliced between the cabinet and vault.

The following equipment must be installed in the No. 9 vault. Contact Traffic Engineering for the latest approved equipment list.

- a. Fiber optic splice enclosure (using gel cable sealing technology)
- b. Hanging bracket assembly.
- c. Tags on both ends of the fiber optic cable for directionality.

**Table 5.3**  
**Fiber Optic Communication Cable Specifications**

ITEM	SPECIFICATION
Fibers per cable	144 strands for main trunk line cables 12 strands for service cables
Cladding diameter	125.0 microns
Core diameter	8.3 microns nominal
Core eccentricity	≤1.0 micron (0.3 typical)
Temperature range	-34°C to +74°C

ITEM	SPECIFICATION
Coating thickness	50±15 microns
Cable construction	Loose tube
Outer jacket	Polyethylene
Bending radius	20 x Dia. minimum
Tensile strength	600 pounds
Strength member	Dielectric
Mode field diameter	9.3±0.5 microns
Zero dispersion wavelength	1300 to 1320 nm
Zero dispersion slope	≤0.092 picosec/nm <sup>2</sup> -km
Cutoff wavelength	1260 nm
Point discontinuities at 1300 nm	≤0.1dB

**5.7.4 Fiber Support Equipment**

A network switch must be installed in the traffic signal control cabinet. Refer to the current APL for the make and model number.

- a. Network Switch with power supply.
- b. Patch panel cables

**5.8 CONTROLLER AND CABINET**

**5.8.1 Controller**

A traffic signal controller with “A” connector and Systems Input/Output terminal facility must be furnished. Refer to the current APL for the make and model number.

**5.8.2 Cabinet**

The Controller Cabinet must be fabricated from aluminum and the finish must be unpainted and clean. Refer to the current APL for the make and model number.

**5.8.3 GPS**

GPS Modules, microprocessor-based Universal Time Base (UTB) devices that provide accurate time-of-day information for traffic signal controllers must be installed in the cabinet. Refer to the current APL for the make and model number.

**5.8.4 ARID Device**

An Anonymous Re-identification Device (ARID) must be installed in the cabinet. Refer to the current APL for the make and model number.

## **5.9**      **DETECTORS**

### **5.9.1**    **Video Detection**

Video detection cameras are typically mounted on the traffic signal luminaire arm. When a 'J' or 'K' pole is used the detection camera must be mounted on the signal pole per the manufacturer requirements and compatible brackets. Refer to the current APL for the make and model number.

### **5.9.2**    **Pre-emption Equipment**

The City uses OPTICOM pre-emption equipment for emergency vehicles. OPTICOM detectors are mounted on the signal mast arms, centered between the two outside signal heads. Refer to the current APL for the make and model number.

## **5.10**     **CCTV CAMERA**

The City uses CCTV traffic monitoring cameras at all intersections. Refer to the current APL for the make, model number and compatible mounting equipment.

The camera must be mounted on the luminaire with manufacturer supplied mounting equipment. The camera must be installed to optimize the overall view of the intersection approaches. The Design Professional must consult with the TMC to finalize the location of the CCTV camera.

## **5.11**     **SIGNAL HEADS**

### **5.11.1**    **Placement of Signal Heads**

The placement of traffic signal heads must follow the policy outlined below (see Figures 5-F and 5-G):

- a. For each unique signal display, there must be a minimum of two (2) signal heads.
- b. For two-lane minor streets without left turn phase, two (2) Type F head must be installed, one (1) on the mast arm and one (1) on the far left pole.
- c. For four or six-lane arterials without left turn phase, there must be two (2) Type F heads on the mast arm.
- d. For left-turn control on two-lane minor streets, two (2) Flashing Yellow Arrow heads must be installed, one (1) on the mast arm and one (1) on the far left pole.
- e. For left-turn control on arterials, two (2) Flashing Yellow Arrow heads must be installed, one (1) on the master arm and one (1) on the far left pole.
- f. For approaches with right turn deceleration lanes, one (1) signal head must be installed on the far right pole.

### **5.11.2**    **Signal Lamps**

#### **5.11.2.1**   **Vehicle Signals**

All signal lamps must be LED and must comply with Vehicle Traffic Control Signal Heads (VTCSH) standards published in the Equipment and Materials Standards of the Institute of Transportation Engineers (ITE).



**5.11.2.2 Pedestrian Signals**

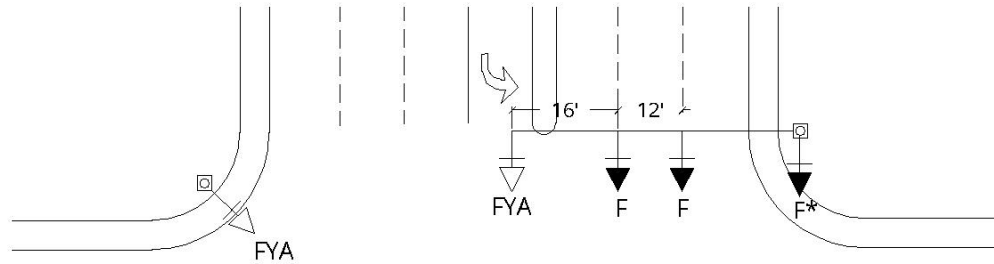
Pedestrian traffic signal lamps must be LED type with pedestrian countdown timers and must be enclosed in an 18-inch pedestrian signal housing built to the Pedestrian Traffic Control Signal Indicators (PTCSI) standards published in the Equipment and Materials Standards of the Institute of Transportation Engineers (ITE). “Hand” and “Man” symbols must be 12 inches in height and conform to PTCSI standards.

**5.12 INTERNALLY ILLUMINATED STREET NAME SIGNS**

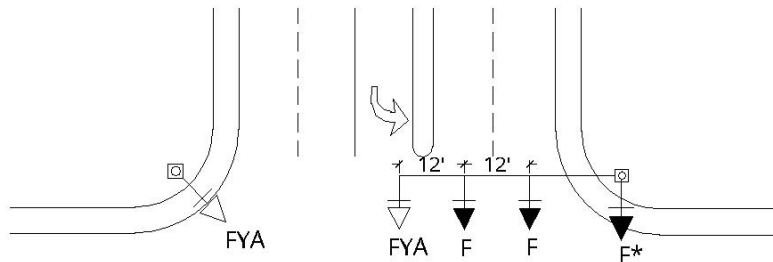
New traffic signal installations require internally illuminated street name signs for all roadways. Sign installations and placement must conform to City Details, C-606 through C-610. If height restrictions and/or conflicts exist, the City may consider alternatives to the details. All designs and installations must be approved by the City Transportation Engineer.

(Intentionally left blank)

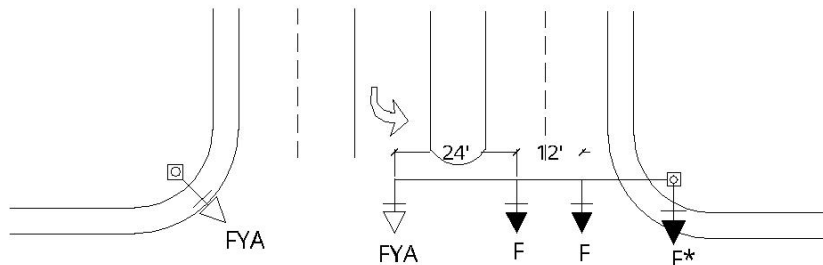
**Figure 5-F  
Signal Head Placement  
With Left Turn Phase**



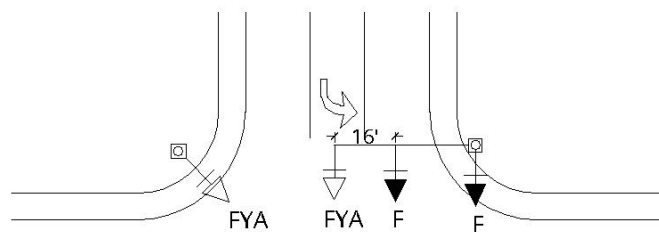
**Six Lanes With Left Turn Phase**



**Four Lanes With Left Turn Phase**



**Four Lanes With Left Turn Phase and Wide Median**

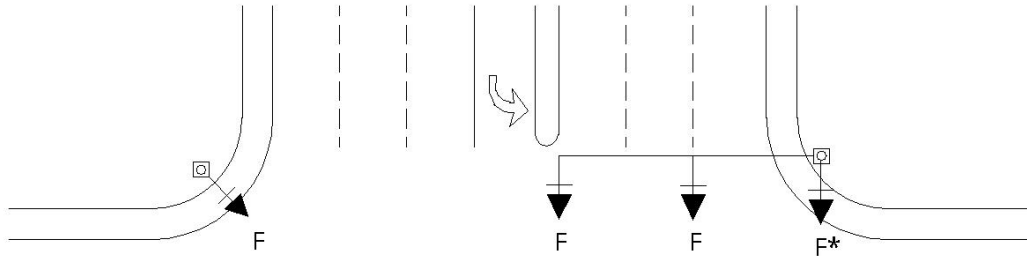


**Two Lanes With Left Turn Phase**

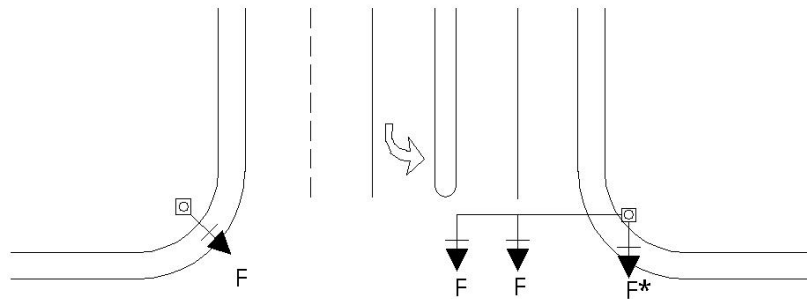
Note: \* Install far-right head when right turn deceleration lane exists for that approach.

F = refers to ADOT Standard Type "F" head  
FYA = refers to MUTCD "Flashing Yellow Arrow" head

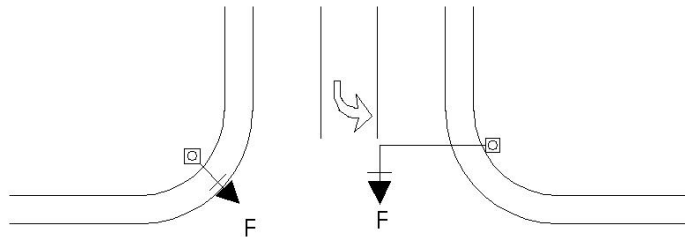
**Figure 5-G**  
**Signal Head Placement**  
**Without Left Turn Phase**



**Six Lanes Without Left Turn Phase**



**Four Lanes Without Left Turn Phase**



**Two Lanes Without Left Turn Phase**

Note: \* Install far-right head when right turn deceleration lane exists for that approach.

F = refers to ADOT Standard Type "F" head  
 FYA = refers to MUTCD "Flashing Yellow Arrow" head

## Chapter 6 - Streetlight Design

### 6.1 GENERAL INFORMATION

Developers of residential, commercial, and industrial properties are responsible for the design and installation of streetlights for the development per the current subdivision code. Streetlight plans and details must be included with the improvement plans and must be submitted for review by the City Transportation Engineer. All streetlight designs, materials and installations for public streets must conform to the City Supplements. Any deviations from these standards must be approved by the City Transportation Engineer. Lighting for private streets must also meet the shielding requirements and illumination requirements of these standards. Under no circumstances will any streetlight or street lighting system be installed without approval of the City Transportation Engineer. For all construction projects, existing direct bury poles must be removed and replaced with the current City standard foundation and pole.

#### 6.1.1 Standards

Streetlight designs must use LED luminaires controlled by City Touch Control Nodes, mounted on steel poles. Spacing of luminaires must be based on illumination level requirements listed in Table 6.1.

New streetlight circuits must be installed below grade.

Streetlights must be fully shielded in such a manner that light emitted by the fixture, either directly from the lamp or indirectly from the luminaires is projected below a horizontal plane running through the lowest point on the fixture where light is emitted.

Intersections at all local and collector type streets must have at least one streetlight at the intersection. Minor and major arterial intersections must have at least two streetlights at the intersection. Near existing or future signalized intersections, streetlight plans must be coordinated with streetlights mounted on the traffic signals. Street surfaces in cul-de-sacs or bubbles must be illuminated to the same standards as local streets.

### **DEVELOPERS MUST COORDINATE THE LIGHTING SYSTEM DESIGN AND ELECTRIC SERVICE FOR THE LIGHTING SYSTEM WITH THE UTILITY COMPANY SERVING THAT SYSTEM.**

The Developer must conform to the latest requirements of the serving utility and pay all energization fees. Design criteria reproduced here for Salt River Project and Arizona Public Service are for reference only, and do not relieve the Developer of any coordination requirements.

Plans for a streetlight system submitted to the City Transportation Engineer for approval must show the location of the nearest existing streetlight including details of luminaire type, output, wattages, mounting height, and pole type. Computerized point-to-point lighting calculations on all plan submissions are required indicating maintained foot-candle levels at

10-foot intervals between luminaires and across the width of the roadway for projects. Streetlight plans must be an individual plan set except as approved by the City Transportation Engineer.

Contractor must provide a product cut sheet identifying the specific luminaire proposed to be used and submit it to the City at the same time as the initial plan submission. If approved, the City's engineer responsible for traffic plan review will forward the cut sheet to SRP, so they can prepare a special billing rate as necessary.

Streetlights for local or collector streets must generally be located at the side lot lines on the south or west sides of the streets. On arterial streets, lights must be placed on both sides of the street in a staggered arrangement. If medians are present and are of sufficient width, streetlights may be placed in the median using poles mounted with double mast arms.

For City streetlight upgrade projects, pole spacing may be varied to meet lot line requirements and an overhead conductor may be installed when underground installation is impractical. The City Transportation Engineer must approve all adjustments.

(Intentionally left blank)

**Table 6.1**  
**Illumination Standards**

STREET TYPE AND ROAD WIDTH (B.C. TO B.C.)	LAND USE	AVERAGE FOOT-CANDLES	UNIFORMITY RATIO (AVE – TO – MIN)	POLE TYPE (Chandler Detail No.)	SPACING PATTERN	MOUNTING HEIGHT
Arterial '76 to 100'	Commercial	1.3	3:1	C-751 (SL-1) or C-756 (SL-17)	Staggered	35.5'
	Intermediate	1.1				
	Residential	0.8				
Industrial Collector 65'	Intermediate	0.7	4:1	C-751 (SL-1) or C-755 (SL-16)	Staggered	35.5'
Residential Collector 45'	Commercial	0.9	4:1	C-751 (SL-1) or C-755 (SL-16)	Single Sided	35.5'
	Intermediate	0.7				
	Residential	0.5				
Local 35'	Commercial	0.7	6:1	C-751 (SL-1) or C-755 (SL-16)	Single Sided	35.5'
	Intermediate	0.5				
	Residential	0.3				

**Commercial:** Downtown areas, regional shopping centers, major sport complexes and other areas with a high level of nighttime vehicular and pedestrian activity.

**Intermediate:** Libraries, community centers, colleges, neighborhood shopping centers, and other areas with a moderate level of nighttime vehicular and pedestrian activity.

**Residential:** Residential developments and other areas with a low level of nighttime vehicular and pedestrian activity.

**Note:** City of Chandler City Transportation Engineer to determine classification to be used in design. These standards apply to all illumination technologies, including LED, HPS, MH, and Induction. Light levels must not exceed 10% of the Average Foot –Candles shown above.

**6.1.1.1 Streets in Low Density Residential Areas**

Low density residential areas with less than 2.5 units per acre may be permitted to install standard street lights only at intersections in combination with bollard or similar style of light at individual driveways as described below.

Within the intersection area (defined by extension of roadway tract, roadway easement, or R/W-boundaries of the intersecting streets), the average illumination must be at least 0.3-foot-candles and the average-to-minimum uniformity ratio must be 6 to 1 or less. Lights must be controlled by City Touch Control Nodes causing them to be turned on automatically during hours of darkness. Any type of lamp or mounting may be used for intersection lighting, including bollard-style lights. Lamp fixtures must be designed to minimize glare for motorists, cyclists and pedestrians.

Lights must also be placed on private property at driveway or sidewalk entry from the private street and must illuminate the corresponding address number. These lights must be controlled by City Touch Control Nodes or similar devices causing them to be turned on

automatically during hours of darkness. These lights must be powered from the individual residences. Homeowner’s associations may choose to specify the type of lights to be used at driveway entries (e.g., bollard, globe, and gas lamp style) by codes, covenants and regulations applicable to their subdivision.

Very low density residential areas, with lots one acre in size or greater, may be permitted to omit street lights altogether, with the written approval of the City Transportation Engineer.

## **6.2 SERVICE AREAS**

Street lighting in the City of Chandler must be designed and installed by the developer. Once installed, ownership must be turned over to the City.

**SRP Area:** This area is served by the Salt River Project (SRP) and includes all areas of the City except APS Area described below.

**APS Area:** This area is served by the Arizona Public Service Company (APS). See Chapter 5 – Traffic Signal Design, Figure 5-A, Electrical Services Boundary Map.

## **6.3 LUMINAIRES**

### **6.3.1 General**

All roadways must use LED luminaires as specified in this Section unless otherwise approved by the City Transportation Engineer. These luminaires must conform to the Minimum Foot-Candles and Uniformity Ratios as specified in Table 6.1.

All street light relocations must be replaced with LED luminaires with illumination levels to meet City standards per Table 6.1.

### **6.3.2 LED Luminaires**

- a. The entire luminaire must be warrantied for a minimum of five years.
- b. Housing must be primarily constructed of corrosion-resistant cast aluminum with a powder coated finish to a neutral color.
- c. All mounting hardware must be of non-corrosive or suitably protected metal.
- d. Luminaire must mount on a standard 2-3/8” outside diameter arm by means of a single piece clamp with an adjustability of +/- 5° to allow for fixture leveling.
- e. Weight must not exceed 28 lbs.
- f. Luminaire must conform to IESNA TM-15 BUG rating of B2-U0-G2 or better. Uplight must be zero (0) light above 90-degrees.
- g. Replacement units as follows:
  - i. The replacement unit for local streets (currently using 100-Watt HPS luminaires) must deliver a minimum of 4,500 initial lumens and operate at less than 30 Watts @ 120V through 277V.
  - ii. The replacement unit for arterial streets (currently using 250-Watt HPS luminaires) must deliver a minimum of 11,000 initial lumens and operate at less than 120 Watts @120V through 277V.



- h. Driver and LED modules must be replaceable as separate units with tool-less plug-in electrical connections.
- i. Cooling must be done with heat sinks. No fans, pumps, or liquids must be used.
- j. Unit must be tested and capable of normal operation in ambient temperatures of -10° C to +50° Celsius.
- k. Luminaire must have a minimum 3-lead terminal board mounted within the housing. Terminal board screws must be of the captive type with wire grips that raise and lower with the terminal screw. Terminals must be capable of accepting #8 to #14 AWG wire.
- l. Luminaire must have an LED Correlated Color Temperature (CCT) of 4,000° K.
- m. Color Rendering Index (CRI) must be a minimum of 70.
- n. L70 (30% lumen loss) must not occur prior to 90,000 hours at 25° C operating temperature. L85 (15% lumen loss) must not occur prior to 50,000 hours. Documentation of independent test results supporting the L70/L85 projections must be provided to the City, if requested.
- o. Driver power factor must be a .90 minimum.
- p. Driver must have a minimum life rating of 90,000 hours.
- q. Power supplies must meet applicable FCC guidelines for interference, with a Total Harmonic Distortion of less than 20%.
- r. Luminaires must be independently tested and comply with IESNA LM79-08 and LM80-08. A copy of all LM79 and LM80 independent test reports must be provided to the City, if requested.
- s. Luminaire housing must be UL listed for wet locations. Optical assembly must be minimum IP-65 rated per IEC. The unit must have a minimum vibration rating of 2G per ANSI C136.31-2001.
- t. Luminaire must be provided with a universal voltage driver capable of accepting 120V through 277V.
- u. Documentation showing compliance with all performance, mechanical, and photometric requirements as detailed above must be provided to the City, if requested.
- v. For approved manufacturers, refer to the Approved Products List (APL).
- w. Luminaire photocontrol receptacle must be designed and constructed to accept a standard plug type, locking, three-pole, three-wire, streetlight photo control. Photocontrol receptacle must also be configured with the addition four conductive pads, as defined in ANSI C136.41.

### **6.3.3 LED City Touch (CT) Control Nodes (Photocells)**

- a. The CT node is a luminaire-based control device that connects the streetlight to the city lighting management system.
- b. The CT Control Node must be twist lock, three-pole type, with a housing fabricated of high impact poly-acrylic with an ultraviolet inhibitor. Photo control must be factory set to turn ON at one-foot-candle, turn OFF at two-foot-candles, and installed facing north.

- c. CT Control Nodes must have a rated life of at least 20 years.
- d. CT Control Nodes must have surge protection arrestor to protect the control node and luminaire from surges produced by power line switching and lighting.
- e. CT Control Nodes used in LED luminaires must fail such that the lamp stays OFF.
- f. For approved CT Control Nodes (photocells), refer to the Approved Products List (APL).
- g. CT Control Nodes must be purchased by the contractor for each new luminaire installed.

**6.4 CT CONTROL NODES MUST BE COMMISSIONED TO THE CITY OF CHANDLER WITH A 10-YEAR CITY TOUCH SERVICE AGREEMENT AND 10-YEAR SYSTEM HARDWARE WARRANTY. POLES**

All new subdivisions and construction projects within the City of Chandler requiring streetlights must use the poles as identified by the following pole details:

- a. City Detail C-751 (SL-1) must be used for all new streetlight installations, except as noted below.
- b. City Details C-753 (SL-6) and C-754 (SL-8) may be used in the APS service area with approval of the Transportation Engineer. City Details C-753 (SL-6) and C-754 (SL-8) may not be intermixed with other types of poles.
- c. City Detail C-755 (SL-16) may be used as an option to C-751 (SL-1) throughout a subdivision or major non-residential development, with pre-approval of City Transportation Engineer. City Detail C-755 (SL-16) may not be intermixed with other types of poles.
- d. City Detail C-756 (SL-17) must be used in lieu of C-751 (SL-1) when overhead height restrictions or clearance problems exist. City Detail C-756 (SL-17) may not be intermixed with other types of poles.

All poles must have a minimum setback of 2.5 feet from back of curb, and a 1-foot clearance from existing or proposed sidewalk. In certain situations, double davit streetlights may be placed in the center of the median less than 2.5 feet from back of curb as approved by the City Transportation Engineer.

In order to maintain aesthetic continuity along major streets, the same type of pole [City Detail C-751 (SL-1) or C-756 (SL-17)] must be used on both sides of the street for at least half-mile sections.

**6.4.1 Pole Fabrication**

**6.4.1.1 City Detail C-751 (SL-1)**

The pole may be either a sectional telescopic design or a tapered design. The number, length and diameter of the sections for a sectional telescopic design must be as specified for the varying pole heights. City Detail C-751 (SL-1) identifies the pole and mast arm required for each type of street.

The adjoining sections must overlap as shown on the standard drawings.

The pole must provide a rigid support at the mounting height for a fixture weighing as much as 50 pounds with a projected area of 3 square feet. The pole must be capable of withstanding a wind load of 80 mph per AASHTO specifications with the fixture attached to a 6- or 8-foot mast arm. The pole must be manufactured from Steel.

A steel pole must be constructed of cold rolled mild steel of a sufficient gauge having yield strength of not less than 36,000 p.s.i.

The pole must be provided with a hand hole and grounding lug attachment at the elevation shown on the standard drawings.

The pole must have a cable entry slot sized and located as shown on the standard drawings. The slot must be free of burrs and sharp edges.

#### **6.4.1.2 City Details C-753 (SL-6) and C-754 (SL-8)**

Poles must be designed at the top to support 200 lbs. tension pulling directly under the street light and must support a 50 lb. luminaires on a 6'-0" arm 2'-0" above the top of the pole with a 3 sq. ft. area. Pole must be capable of withstanding an 80-MPH wind load per AASHTO specifications. Steel or aluminum poles are acceptable.

After fabrication, the pole must be sandblasted to remove all loose scale, rust, corrosion products, grease, dirt, and other foreign products.

#### **6.4.1.3 City Detail C-755 (SL-16)**

The height and reach of all poles must correspond to the dimensions of City Detail C-755 (SL-16).

Poles must be designed to support the weight of the luminaires and withstand an 80-MPH wind load per AASHTO specifications. The pole manufacturer must provide structural calculations and a certificate of compliance to the specifications.

Pole shafts must be steel of 48,000 p.s.i. minimum yield after fabrication. All pipes must be ASTM A-53 grade "B", anchor bolts ASTM 1-307, and base plate and flanges ASTM A-36.

#### **6.4.1.4 City Detail C-756 (SL-17)**

The height and reach of all poles must correspond to the dimensions of City Detail C-756 (SL-17).

Poles must be designed to support the weight of the luminaires and withstand an 80-MPH wind load per AASHTO specifications. The pole manufacturer must provide structural calculations and a certificate of compliance to the specifications. Pole shafts must be steel of 48,000 p.s.i. minimum yield after fabrication. All pipes must be ASTM A-53 grade "B", anchor bolts ASTM 1-307, and base plate and flanges ASTM A-36.

## **6.4.2 Pole Preparation, Painting, and Identification**

### **6.4.2.1 City Details C-751, C-753, C-754, and C-756 (SL-1, SL-6, SL-8, and SL-17)**

After sandblasting, the pole must be galvanized. The galvanizing must conform to ASTM A123, latest edition. Zinc (hot galvanized) coating must be applied on products fabricated from rolled, pressed, and forged steels, plates, bars, and strip.

### **6.4.2.2 City Detail C-755 (SL-16)**

After fabrication, the steel poles must be sandblasted, primed and powder coated. Sandblasting must be in accordance with SSPC Specification SP-6-63. The color must be a Dark Bronze equal to Val Spar V40-07.

### **6.4.2.3 Pole Identification**

#### **A. APS**

Contractor to install self-adhesive day and night 1" x 1-1/2" black on yellow background stickers. Stickers to be mounted vertically a minimum of 6'-0" from ground. Numbers should be placed on the side of the pole facing the street. APS will provide the numbering on the APS electrical drawings.

#### **B. SRP**

Streetlight numbers are placed on the side of the pole facing the street 6'-0" above finish grade. Surfaces to which numbers are applied must be clean and free of dirt. Numbers for Joint Use wood poles installed by SRP to be applied to a plastic I.D. plate, which are nailed to the pole. These pole numbers typically do not have alphabetic characters preceding the numbers. Numbers for steel poles are installed by the Contractor to be applied directly to the steel pole. The number to be installed is shown on the job order and will have a "CH" prefix.

### **6.4.2.4 Existing Poles**

Existing Light Gray poles should be repainted to match existing color or per the APL specifications.

## **6.4.3 Approved Manufacturers**

Refer to the Approved Products List (APL) for approved pole, paint, and conduit manufacturers.

## **6.4.4 Wood Poles**

Existing wood electrical distribution system poles may be used for mounting of streetlights, only if approved by the City Transportation Engineer. Use of these existing wood distribution poles must meet one of the following criteria:

- a. Reduce the pole-forest effect.
- b. Where there is no other choice and only in exceptional cases.

Luminaires mounted on existing wood distribution poles must be furnished and installed by the utility company owning said distribution line, regardless of previously delineated service

areas. The developer must coordinate the design and installation of the luminaires in these areas and must pay the "Investment By Others" (IBO) costs to the appropriate utility (APS and SRP have standard IBO rates). The developer is not permitted to climb on or attach to these utility company poles. The City will own the newly installed luminaires.

#### **6.4.5 Pole Bases**

Concrete bases are required for all streetlights. Concrete for pole foundations must be Class A (3000#) and conform to MAG Section 725.

Reinforcing Steel for concrete foundations must conform to grade 60 requirements of MAG Section 727.

### **6.5 JUNCTION BOXES**

#### **6.5.1 Installation**

All junction boxes must be installed at finish grade. All junction boxes must be installed adjacent to each pole per City Detail C-757 (SL-14A).

#### **6.5.2 SRP Service Area Junction Box**

The following is referenced for installation purposes. All J-boxes must be placed within 3 feet of streetlight pole and should be located in the public utility easement where available. City Transportation Engineer must approve any exceptions.

Junction box must be constructed of Polymer Concrete or High Density Polyethylene (HDPE) material with a flush mounted bolt-on composite lid. The box must be constructed so as to be fire retardant. No wood components, or other materials, which can be damaged by water or insects, will be permitted. The color of the lid must be gray with the word "STREET LIGHTING" on it. Dimensions of the box must be approximately 21" x 15" x 12". The lid must be set inside the top flange and secured in place with a minimum of one recessed 3/8" Penta Head bolt. The Penta Head bolt must have 0.56" flats per ANSI C57-1226. Box dimensions shown are approximate. Engineering approval of actual dimensions is required prior to the first purchase only. This junction box must be per SRP Specification UVJB4. Refer to SRP electrical plans to ensure no restrictions or changes have occurred. Refer to City Detail C-757 (SL-14C).

#### **6.5.3 APS Service Area Junction Box**

The following is referenced for installation purposes. APS will supply all necessary junction boxes for new streetlights.

##### **6.5.3.1 10' x 15" APS Junction Box**

Junction box must be constructed of a fiberglass or equal material. The outer coating of the material must be capable of withstanding abrasion and sunlight and must be impact resistant. The entire box must be capable of continued water immersion for a prolonged period, with no structural degradation or visual blemishes. The box must be constructed so as to be fire retardant. No wood components, or other material, which can be damaged by water or insects, etc., will be permitted. Samples of each new type of box, or an existing box,

which has had a design change, must be supplied to the City for testing. The color of the box must be forest green or black with a green structural plastic lid. Approximate dimensions must be such that a minimum opening of 11-3/4" x 17" will exist when the lid has been removed. The lid must be set inside the top flange and marked "STREET LIGHTING". The lid must be secured in place with a minimum of one recessed 3/8" Penta Head bolts. The Penta Head bolt must have 0.56" flats per ANSI C57-1226. Box dimensions shown are approximate. Engineering approval of actual dimensions is required prior to the first purchase only. Two fuse holders are required by APS, one in pole and one in junction box. Refer to City Detail C-758 (SL-15).

### **6.5.3.2 14" x 24" APS Junction Box**

Junction box must follow the same requirements as 10" x 15" APS junction box except minimum opening must be 14" x 24" when lid has been removed. Refer to City Detail C-757 (SL-14B).

## **6.6 CONDUCTORS**

Conductors must be No. 12 AWG solid soft-drawn copper and bear the UL label except for green grounding. Green ground must be No. 8 AWG. Insulation must be type THWN. The following wire color code must be used:

- a. Black - 120V power
- b. Black & Red - 240V Power
- c. White - Neutral
- d. Green - Grounding

Conductors for each luminaire must be connected to the luminaire, extended down the pole, and terminate conductors in all areas at pullbox adjacent to pole per City Detail C-758 (SL-15). Connectors must be made as stipulated in Section 6.10 of this chapter.

It is mandatory that the power conductor for each luminaire be fused using Bussman No. HEB-AA in-line, waterproof fuse holders. Install the fuse holders inside the pullbox and install Bussman KTK fuses as shown on City Detail C-758 (SL-15).

## **6.7 TRENCHING AND BACKFILL (SRP AND APS SERVICE AREAS)**

Developer must coordinate trenching requirements with the appropriate utility company. Conduit excavation, backfill and compaction detail must be shown on plans and meet City minimum coverage requirements.

## **6.8 CONDUITS**

Conduits must be installed between poles and junction boxes in all areas as shown on City Detail C-758 (SL-15). Conduit required for street, alley or driveway crossings should be 2-1/2", schedule 40 polyvinyl chloride for all installations.

Conduit runs between streetlight pole and junction box must be 1-inch. The conduit must be either 1-inch schedule 40 polyvinyl chloride or liquidtight flexible nonmetallic conduit that

confirms to the installation and use specifications set forth in the 1997 National Electric Code, section 351. The flexible conduit must not be used under the following conditions:

- a. Where subject to physical damage;
- b. Where any combination of ambient and conductor temperatures is in excess of that for which the liquidtight flexible nonmetallic conduit is approved;
- c. In lengths longer than 6 feet;
- d. Where voltage of conductors is in excess of 600 volts, nominal.

Refer to Section 356 of the 2011 *National Electric Code* for additional criteria on installation and materials for liquidtight flexible nonmetallic conduit.

## **6.9 TRAFFIC CONTROL**

The Contractor or the utility company is responsible for providing work zone traffic control in accordance with Chapter 7 of this manual.

## **6.10 STREETLIGHT ENERGIZATION FOR SUBDIVISIONS IN SRP AREA**

The purpose of this procedure is to ensure timely energization of streetlights within subdivisions in the SRP service area.

The streetlight energization procedure is separated into three primary areas of responsibility: that of the City of Chandler, the Developer/electrical Contractor, and the Salt River Project.

### **6.10.1 CITY OF CHANDLER**

- a. The City will review and approve the proposed streetlight plans.
- b. The City will return the approved plans (two sets) along with a letter of authorization and a streetlight energization request to the Developer.
- c. The City authorizes SRP to begin streetlight energy billing after completion of the job order.

### **6.10.2 DEVELOPER/CONTRACTOR**

- a. The Developer must coordinate all project activities with the utilities in the area including submittal of approved streetlight plans, civil plans, authorization letter to bill the City, and the energization request form previously submitted to the Developer.
- b. The Contractor will install all the streetlights as shown in the approved job plan.
- c. The Contractor will install junction boxes in accordance with Section 6.5 of this chapter and City Detail C-757 (SL-14A).
- d. The Contractor must affix a streetlight number on each pole as shown on the job order plan prior to final inspection according to City Detail C-751(SL-3).
- e. Within new subdivisions in the SRP area, the Contractor will connect and energize each streetlight in the junction box utilizing the connectors in place as shown on City Detail C-758 (SL-15). In all other cases, the connection will be made by servicing utility company.



- f. Contractor must limit streetlight outage to no more than three calendar days.
- g. GPS location must be obtained for all new and relocated street light poles.

**6.10.3 SALT RIVER PROJECT**

- a. SRP will initiate design of a job order plan to serve a new development when a letter of authorization, approved civil plans and approved streetlight layout have been received.
- b. SRP will inspect and coordinate the trenching detail and underground conduit requirement for the primary and secondary conductors.
- c. SRP will schedule construction crews to install transformers, pull wire, terminate and energize all conductor cables following receipt of the corresponding recorded subdivision plat.
- d. SRP will add installed and/or planned streetlight units for the subdivision to the City of Chandler monthly lighting service bill after completion of the job order work at the site.
- e. GPS location must be obtained for all new and relocated street light poles.

(Intentionally left blank)

## Chapter 7 - Traffic Barricade Design

### 7.1 **GENERAL INFORMATION**

This chapter is intended to help provide safe conditions for motorists, pedestrians and workers on City streets, and to reduce congestion and confusion by providing uniform applications of standard traffic control devices in construction and maintenance areas. The provisions for public protection established herein are applicable to all persons, contractors, utilities and other agencies, including City forces, performing work in the City of Chandler public right-of-way, and for temporary traffic control during public activities such as parades and other special events that use the public right-of-way. Appeals of penalties may be directed to the Development Services Director or designee. When emergency conditions occur, immediate action must be taken to protect the public. The requirements of this chapter must be implemented as soon as practical at each location.

This chapter establishes basic uniform requirements for traffic control in construction and maintenance areas and prescribes specific standards for the manufacture, application and maintenance of temporary traffic control devices. These requirements, standards and methods of application have been prepared to conform to the U.S. Department of Transportation, Federal Highway Administration *Manual on Uniform Traffic Control Devices (MUTCD)*. Minor deviations exist in some areas where field experience and engineering judgment has shown improved traffic operation will result. Typical applications of approved devices are illustrated herein. Application of these devices to other situations must be handled consistent with the methods illustrated.

### 7.2 **PURPOSE OF BARRICADING AND CHANNELIZATION**

The purpose of barricading and channelization is to:

- a. Protect the motoring public
- b. Protect pedestrians and workers
- c. Provide a safe, orderly flow of traffic
- d. Provide expedient and safe construction and maintenance
- e. Maintain good public relations

### 7.3 **PERMISSION TO RESTRICT CITY STREETS AND SIDEWALKS**

#### 7.3.1 **Requests**

Requests for permission to close or restrict streets, sidewalks, or alleys can take place in one of two ways:

- a. For emergency restrictions during non-working hours, contact the Police Department at (480) 782-4130. During working hours, contact the Transportation Engineering Division at (480) 782-3300.
- b. For partial restrictions (lane closures) or street closures, apply for a Road Restrictions and Closures Permit online.

### **7.3.2 Traffic Control Plan**

A traffic control plan must be prepared and submitted for approval for all partial restrictions and street closures.

The purpose of a traffic control plan is to encourage forethought as to the time of day, days of week, sequence of construction, degree of restriction required, and traffic control needed. Traffic control plans may range in complexity from use of a typical illustration in this chapter to a detailed site plan showing signing, barricading, detours, pedestrian walkways, construction fences, and project phasing. In all cases, the traffic control plan must satisfactorily accommodate large or unusual projects or events, and advance consultation and review of the traffic control plan with City staff is encouraged.

### **7.3.3 Notice for Restrictions**

Three working days (72 hours) advance notice is required for partial restrictions on arterial and collector streets, and all restrictions or closures on local streets.

Ten working days advance notice is required for complete closure of any arterial or collector street. It will be the responsibility of the applicant to prepare and submit a detailed traffic control plan, detour routing map, and a news release explaining the reason for the closure, its approximate duration and the alternate traffic routing plan. These materials must be submitted with the Road Restrictions and Closures Permit application.

### **7.3.4 Alley Restrictions or Closures**

All requests for alley restrictions or closures must be discussed with the Solid Waste and Recycling office at (480) 782-3515 to determine an acceptable schedule for the closure, prior to submitting the Road Restrictions and Closures Permit application. Five working days advance notice is necessary to notify affected residents and to reschedule garbage and recycling pickup.

### **7.3.5 Road Restrictions and Closures Permit**

The City reserves the right to deny or revoke any Road Restrictions and Closures Permit at any time when in their judgement the traffic restriction could or has resulted in intolerable congestion, major inconvenience, accident potential or hazard to workers.

### **7.3.6 Work Zone Traffic Control**

The City's Traffic Engineering Specialist and Off-site Inspectors are responsible for monitoring that the work zone traffic controls are planned and implemented in accordance with this chapter. The Contractor in responsible charge of the work is responsible for the traffic control. The Traffic Engineering Specialist, in cooperation with Off-site Inspectors, is authorized to direct a contractor or supervisor of work in progress to take steps necessary for correction of deficiencies in work zone traffic controls. The restricted hours of work may be extended at the discretion of the City Transportation Engineer or his/her designee. Assistance with work zone traffic control for conditions not covered by this chapter may be obtained from the Traffic Studies Engineer at (480) 382-3450, or the City Transportation Engineer at (480) 782-3470.

### 7.3.7 Construction Signs

The Contractor must provide construction signs identifying the name of the company performing the work, contractor name, general description of work, construction time frame, etc. as required by City Code 46-2.7E.

## 7.4 GENERAL TRAFFIC REGULATIONS

The following are minimum traffic control requirements for all traffic restrictions, unless otherwise provided for in the approved street closure permit.

- a. Traffic restrictions are not permitted at signalized intersections or on arterial streets during the peak traffic hours of 6:00 AM to 8:30 AM and 4:00 PM to 7:00 PM weekdays except as approved by the City Transportation Engineer. Traffic restriction hours may be extended at the discretion of the City Transportation Engineer or his/her designee. For six-lane roadways, one lane closure may be permitted in the non-peak direction based on peaking characteristics, as determined by the City Transportation Engineer.
- b. Traffic restrictions are not permitted on accesses to major shopping centers during the hours of 9:00 AM to 10:00 PM on Saturdays. In rare instances, exceptions may be granted where the restrictions do not cause the intersection to exceed capacity or create any significant delays.
- c. Left-turn lanes should be maintained at all times. If it can be demonstrated that closing the left-turn lane would result in improved traffic flow, or reduce delays, closure of the left-turn lane may be permitted.
- d. During off-peak traffic hours, a maximum reduction of one through lane in each direction is permitted. Turn lanes may be restricted if approved by the City Transportation Engineer or his/her designate. Additional lane restrictions may be authorized during emergencies, nights and weekends. Weekends are defined as Friday at 9PM to 5AM on Monday. Nights are defined as 9PM to 5AM.
- e. During off-peak traffic hours when traffic lanes are restricted at multiple lane signalized intersections with left-turn lanes, the left-turn lanes may be used with channelization and turn restrictions to provide a minimum of two lanes for each direction, if approved by the City Transportation Engineer or his/her designate (see Figures 7-P, 7-U and 7-V).
- f. The use of City of Chandler police officers at barricade locations within the City is preferred and must be given first priority in filling these jobs. Contractors, utilities, and agencies should contact the Extra Duty Coordinator (480-782-4204) at least 24-hours in advance to schedule officers for this purpose. The City Transportation Engineer, or his/her designee, will determine the number of police officers, if any, required by time of day. See Section 7.6.5 of this chapter for typical situations where officers may be used.
- g. A traffic lane must not be considered satisfactorily open to traffic unless it is paved with hot or cold mix asphalt if surrounded by, or adjacent to, existing pavement. Where all existing pavement has been removed, a traffic lane must not be

- considered as satisfactorily open to traffic, unless graded reasonably smooth and maintained dust free as determined by the City Transportation Engineer or his/her designate. Small openings in the roadway surface may be bridged with steel plates level with the abutting pavement (pavement milled around edges of opening). Roadway depressions should not exceed 1" in 10'. All visible pushing/shoving of pavement must be corrected. All temporary pavement must be inspected daily, and above maintenance issues corrected within 24 hours.
- h. With an approved permit, local streets may be closed except for local access when construction or maintenance requires.
  - i. Local access must be maintained to all properties on all streets (arterial, collector and local) at all possible times. When local access cannot be maintained, the contractor, utility or other agency must notify affected property owners, residents or tenants a minimum of 24 hours in advance and restore access as soon as possible.
  - j. Access to fire stations, police stations, hospitals, post offices and schools must be maintained at all times. When access restrictions are necessary, the contractor, utility or other agency must coordinate such access restrictions with the responsible person in charge of the affected fire station, hospital, police station, post office or school.
  - k. Coordination with special events or parades is necessary when construction and maintenance operations conflict with such events. Generally this requires repair, cleanup and preparation of conflicting areas by the Contractor before the day of the event to provide clean, safe conditions during the event.
  - l. Construction and maintenance activities are restricted during the holiday season of November 15 through January 1, on streets adjacent to or serving as primary access to large shopping centers. Construction and maintenance activities that interfere with traffic flow near shopping areas and on high volume streets must be carefully evaluated and imposed only when absolutely necessary. In rare instances, exceptions may be granted where restrictions do not cause the intersection to exceed capacity or create any significant delays.
  - m. Devices placed for work zone traffic control (e.g., barricades, vertical panels, barrels, signs) must be removed from the street right-of-way at the time that work is completed. Devices left in the right-of-way for more than 24 hours after stopping work will be removed by the City. Devices removed by the City may be reclaimed at the City Yard (975 East Armstrong Way) after payment of fees covering City costs for removal and storage.
  - n. Set up of barricading and traffic control must be undertaken by qualified and experienced personnel only. The City of Chandler requires that a contractor delegate the daily set up to a barricading company when working on arterial roads. Removal of barricading after completion of daily tasks may be undertaken by either the Contractor or the barricading company.
  - o. On parallel arterials, lane closures (of more than one day in duration) are restricted, where detoured traffic from one closure could encounter restrictions

- at another closure. The separation of closures on parallel arterials must be more than two miles apart in radius.
- p. Detours less than 3 days in duration must use aggregate base course (ABC), AC millings, or temporary AC. Detours between 3 days to 2 weeks in duration must use AC millings or temporary AC. Detours greater than 2 weeks must use temporary AC. Temporary AC is defined as 2" EVAC A19 on 5" ABC, or as approved by a geotechnical engineer.
  - q. When a difference in AC pavement elevation is created perpendicular to traffic flow, the contractor, utility or other agency must provide at the end of the work day a temporary AC fillet over an 18" length. The Contractor is required to mill the fillet prior to final AC placement.
  - r. The contractor, utility or other agency is responsible to remain at the work site until all barricading is removed from the roadway by the barricade company. The contractor, utility or other agency may have the option to remove barricades. All barricading must be removed from the roadway within one hour of work completion. If barricades remain longer than one hour after work completion, the contractor, utility or other agency may be subject to penalties.
  - s. The contractor, utility or other agency must contact Transportation Engineering prior to moving barricades at signalized intersections. Please contact the City's Traffic Management Center at 480-782-3471.
  - t. Failure to comply with a Road Restrictions and Closures Permit will result in a \$2,000 per day penalty. Failure to comply with the Traffic Control Plan will result in a \$500 per day penalty. Possible exceptions to penalties may include emergencies affecting public health and safety, or extreme weather conditions such as the 50 or 100-year storm. Exceptions would not be granted for typical rain delays or known adverse soil conditions. To obtain payment, the City may take actions such as withholding future Road Restrictions and Closures Permits or final acceptance of offsite improvements.
  - u. If traffic is being shifted between lanes at a signalized intersection, the Contractor must notify the City 24-hours in advance and precisely at the time of the switchover. Please contact the City's Traffic Management Center at 480-782-3471.

## **7.5 EXISTING TRAFFIC CONTROL DEVICES**

During construction and maintenance operations, it is important that existing traffic control devices be kept compatible with the traffic restrictions imposed. This includes signs, traffic signals, and pavement markings. Some devices will remain applicable to traffic and must be maintained while other devices must be covered, relocated or removed. Requirements for each group of devices are detailed in this section.

### **7.5.1 Traffic Signs**

The contractor, utility or other agency must maintain all existing STOP, YIELD and street name signs erect, clean and in full view of the intended traffic at all times. If these signs interfere with construction, the contractor, utility or other agency must temporarily relocate

the signs to permit construction, but the devices must be kept in full view of the intended traffic. The Traffic Engineering Specialist or the Off-site Inspector must approve the temporary relocations of signs. Portable signs should be used to supplement these signs when maintained in other than normal locations.

Other applicable signs must also be maintained erect, clean and in full view of the intended traffic by the contractor, utility or other agency at all times. Existing signs no longer applicable must be removed by the contractor, utility or other agency without damage, and delivered to the sign shop at the City Yard (975 East Armstrong Way). The Off-site Inspector must be notified of all sign removals, at the time of removal.

When construction is complete, the contractor, utility or other agency will reset all temporarily relocated signs to permanent locations.

### **7.5.2 Traffic Signals**

The contractor, utility or other agency must maintain that existing traffic signal equipment (except vehicle detector sensing devices and left turn arrows) is fully operational in the existing locations. They must also be in full view of the intended traffic at all times, unless otherwise specified in this chapter, in the approved traffic control plan, or in the Road Restrictions and Closures Permit.

Left turn arrows must be de-activated by the Traffic Management Center when left turn prohibitions are in effect. One working day (24hours) advance notice to the Traffic Management Center (480-782-3471) is required. The contractor, utility or other agency must also notify the Traffic Management Center at the time the left turn prohibition takes effect. The contractor, utility or other agency must provide the same one working day (24-hour) advanced, and time of, notification for re-activation (removal of the prohibition) of the left turns.

The contractor, utility or other agency must notify the Traffic Management Center one working day (24 hours) prior to the start of any construction in the vicinity of a signalized intersection.

The contractor, utility or other agency must exercise due care to prevent damage to all existing traffic signal equipment. Should damage occur, the Traffic Management Center must be notified immediately to make the necessary temporary repairs to restore traffic signal operations.

All traffic signal equipment relocations and/or installations of temporary signal equipment must be coordinated by the contractor, utility or other agency with the Traffic Signal Supervisor (480-782-3456). One working day (24 hours) advance notice is required. When temporary equipment or new equipment is installed to replace existing equipment, the temporary or new equipment must be fully operational before the existing equipment is removed. The contractor, utility or other agency must restore all signal control equipment to



the original locations or new locations, if so specified, as soon as possible after all the work in the immediate areas is completed.

### **7.5.3 Pavement Markings**

Existing pavement markings that conflict with the vehicle path indicated by barricades and channelization and cause driver confusion, must be removed or obliterated by the contractor, utility or other agency, as directed by the Transportation Engineering Division. The City requires use of portable traffic control devices that under normal conditions dominate pavement markings. Pavement marking obliteration will usually be required only on long-term construction projects or detours. However, removal or obliteration of existing pavement markings may be required at any location when visual inspection and/or crash history shows driver confusion exists due to pavement markings.

## **7.6 TEMPORARY TRAFFIC CONTROL DEVICES**

Temporary traffic control devices are used to delineate hazards, alert and guide motorists, and to protect pedestrians and workers. They fall into the following six basic categories.

- a. Signs
- b. Barricades and channelizing devices
- c. High-level warning devices
- d. Pavement markings
- e. Police officers and flaggers
- f. Portable barriers

The contractor, utility, or other agency must provide and maintain all necessary temporary traffic control devices, including regulatory signs, to protect and guide vehicles and pedestrians, and to protect workers during traffic restrictions.

Temporary traffic control devices must be:

- a. Manufactured in a workmanlike manner to conform to the *Manual on Uniform Traffic Control Devices*. Stenciled signs are not allowed except during emergency conditions;
- b. Installed prior to the start of all restrictions;
- c. Properly maintained and operated when restrictions exist;
- d. Kept clean and fresh appearing at all times; and,
- e. Kept in place only as long as needed and removed immediately thereafter.

Where operations are performed in stages, only devices applicable to the restrictions present must be in place. All signs that do not apply to the restricted conditions must be removed, covered or turned away from traffic by the contractor, utility or other agency so as not to be readable by oncoming traffic. Portable signs should be turned away from traffic at a 45-degree angle because the sign edge is not visible when turned parallel to traffic and can be hazardous.

Channelization, including “KEEP RIGHT/LEFT” signs, must be provided whenever traffic is moved across the street center line, the existing center line is obliterated, or opposing traffic is maintained in other than the normal traffic lanes.

Where existing or new signing and/or pavement markings must be installed or replaced, the necessary temporary traffic control devices must be provided and maintained by the contractor, utility or other agency until such permanent work is completed.

All temporary traffic control devices must be ballasted with sandbags or other approved ballast by the using contractor, utility, or other agency when necessary. Ballast must be placed on lower parts of the frame or on the base and must not be placed on top of any striped rail. The use of rocks, concrete or asphalt chunks, concrete blocks, etc., as ballast is prohibited.

### **7.6.1 Signs**

Signs are a very important part of temporary traffic control. Signs are used to alert, advise and guide the motorist. Temporary traffic control signs are necessary in advance of traffic restrictions and whenever a motorist has to change his/her path of travel. It is especially important to use warning signs well in advance of traffic restrictions and place them so they will convey their intended message most effectively.

Temporary traffic control signs fall into the same three major categories as do other traffic signs, namely:

- a. Regulatory signs;
- b. Warning signs; or
- c. Guide signs.

Many signs normally used elsewhere also find application for signing construction and maintenance operations. Most of these signs are included in this chapter, but other signs in the MUTCD may be used or required. Each sign must be displayed only for the specific purpose described in the manual and indicated by the sign legend. Uniformity of signs and sign usage is necessary so that similar conditions will always be marked with the same type of sign whenever the condition occurs. In this manner, the motorist becomes conditioned to the required action indicated by signs. The less variation in signs, the fewer responses the motorist must learn.

Temporary traffic control signs for construction and maintenance operations follow the basic standards for all traffic signs as to size, shape and color. Warning and guide signs in construction and maintenance areas, however, must have a black legend on an orange background. Color for other signs must follow the standards set by the MUTCD.

Standard minimum sign sizes, sign colors and sign shapes are shown in the illustrations of the individual signs rather than in detailed specifications in the text. The size and stroke of

the legend or symbol must be the largest possible permitted by the size and design of the sign consistent with good legibility and the MUTCD.

The dimensions of signs shown herein are for standard minimum sizes, which may be increased when necessary for greater legibility or emphasis. Deviations from standard sizes herein must normally be in 6-inch increments. Signs mounted on posts along the side of the street (STREETSIDE SUPPORTS) must be at least 6 inches larger per dimension unless otherwise indicated in the sign illustrations.

Two orange or fluorescent red-orange flags 16 inches square or larger must be mounted on all streetside sign supports, and on all portable signs used for advance warning. They may also be mounted on other signs for added visibility.

All signs used during hour of darkness must meet the following criteria.

- a. Be reflectorized with smooth surface weather-proof reflectorized sheeting.
- b. Be equipped with operating Type A flashing barricade warning lights when mounted on portable supports used on City streets.
- c. Be equipped with operating Type B flashing warning lights when mounted on streetside supports for advance warning at arterial street construction projects.
- d. Have a minimum application of 150 square inches of orange weatherproof reflectorized sheeting on the back of signs exposed to opposing traffic. The reflectorized sheeting must be placed in strips not less than 5 inches wide along each outer edge of the sign. Signs placed in two-way left turn lanes must have at least one Type I barricade placed 10 feet behind the sign to alert opposing traffic.

All signs mounted on portable supports must have minimum heights to the bottom of signs as listed below.

- a. Regulatory: 36 inches, except R4 - 7a and 8a (KEEP RIGHT/ LEFT) and R11 - 7, 8 and 11 (SIDEWALK CLOSED/PEDESTRIANS) which must be 18 inches.
- b. Warning: 12 inches, except W1-6 (TARGET ARROW) which must be 36 inches.
- c. Guide: 24 inches.
- d. Combination regulatory and warning: 12 inches.

All signs mounted on streetside posts must have a minimum height of 7 feet to the bottom of the signs.

Barricades, vertical panel channelizing devices and flag type high level warning devices are acceptable portable sign supports for City streets. When flag type high level warning devices are used as sign supports, they must be provided in addition to other flag type high level warning devices required by this chapter. Ballast (sandbags) should be placed on the base of all portable signs that are unattended.

Metal sign posts and steel street light poles are acceptable streetside supports. Signs must not be mounted on wood power poles. Streetside signs should not normally be placed in sidewalks or walkways, but when necessary, care should be taken to minimize interference to pedestrians.

As a general rule, portable signs must be located on the right side of the street when right lane traffic is restricted, and on the centerline or median when the left lane traffic is restricted. Streetside signs must be located on the right side of the road and on protected medians. Where special emphasis is required, and where more than one lane of traffic in any one direction is effected, dual signs should be provided approximately opposite each other.

Portable supports should be used for short-term and moving operations. Streetside supports must be used for construction speed limit and advance warning signs on long term fixed construction projects, such as arterial street construction.

For maximum mobility on certain types of construction and maintenance operations, signs may be mounted on a vehicle stationed in advance of the work, or moving along with it. This may be the working vehicle, as in the case of crack and chip sealing, or a vehicle provided expressly for this purpose.

Mobile sign displays such as electric changeable message signs and arrow panels, may be mounted on a trailer, may be provided with self-contained electric power units for flashers and lights, or may be mounted on a regular maintenance vehicle. Vehicles used specifically for mobile sign display should be equipped with an impact attenuating device to provide additional safety for workers and motorists.

#### **7.6.1.1 Regulatory Signs**

Regulatory signs impose legal obligations or restrictions on all traffic and are enforced by the Police Department. To be enforced, their use must be specified in the approved Road Restrictions and Closures Permit. Special care must be used to insure proper use, maintenance, and removal of all regulatory signs in a timely fashion. Conflicting existing regulatory signs must be covered or removed.

All regulatory signs are provided by the contractor, utility, or other agency. Commonly used signs are illustrated in Figures 7-A and 7-B.

**Figure 7-A  
Regulatory Signs**



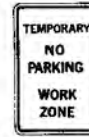
R1-1  
30" x 30"



R1-2  
30" x 30" x 30"



R5-1  
24" x 24"



R8-8  
12" x 18"



R3-2  
24" x 24"  
4" x 24"



R3-1  
24" x 24"



R3-7  
(LEFT)(RIGHT)  
24" x 24"



R3-8  
(LEFT)(RIGHT)  
24" x 24"



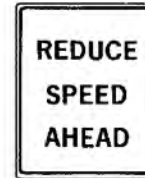
R3-5  
(LEFT)(RIGHT)  
18" x 24"



R6-2  
(RIGHT)(LEFT)  
18" x 24"



R6-1  
(RIGHT)(LEFT)  
36" x 12"



R2-5a  
24" x 30"



W20-6  
R2-1(25)



W20-6  
R2-1(35)



W20-6  
R2-1(45)

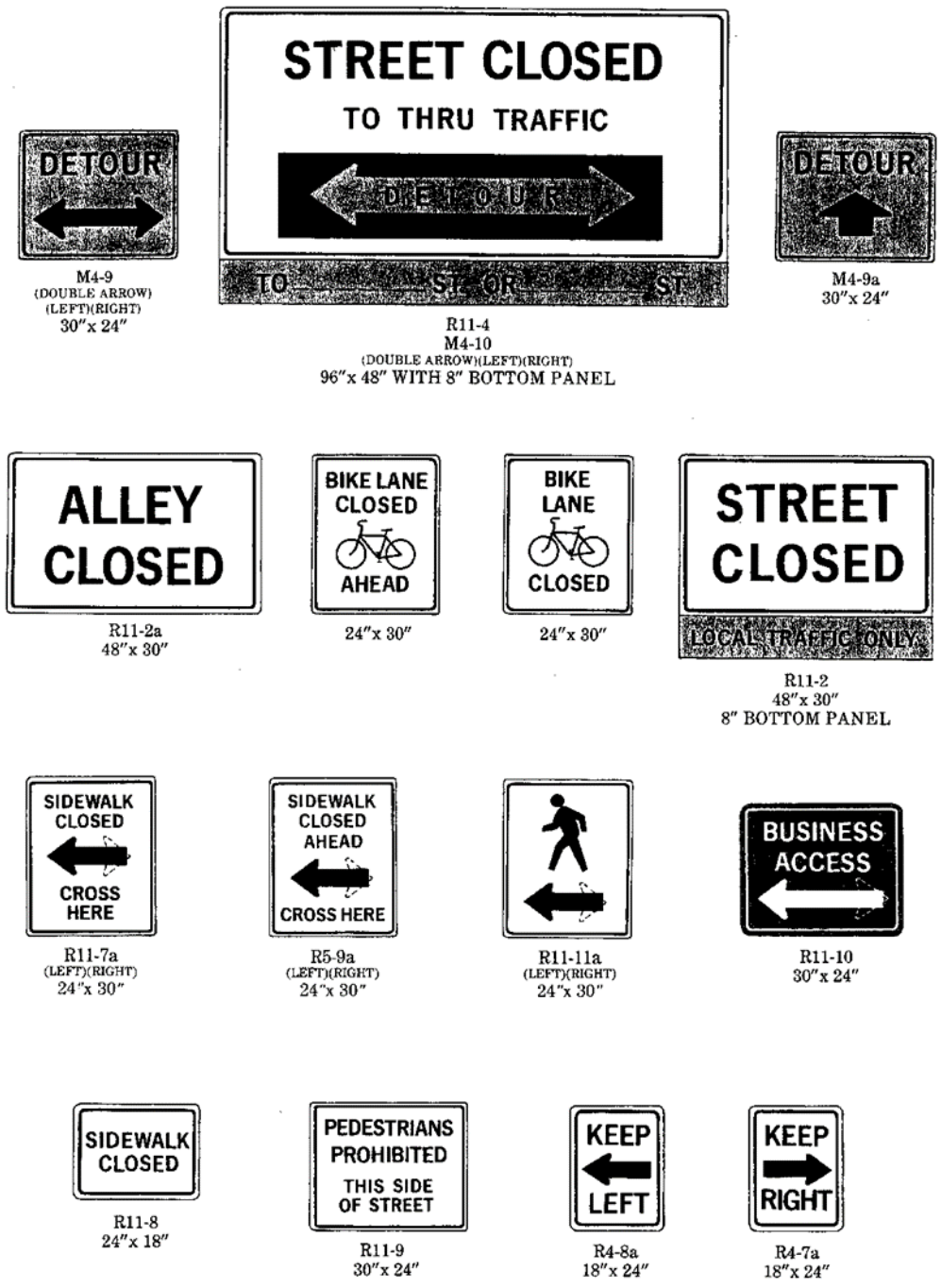
SPEED LIMIT SIGN SIZES

Sign  
W20-6  
R2-1

City Street Post Mounted  
All Freeway & Expressway  
36" x 36"  
24" x 30"

City Street  
Portable  
24" x 24"  
18" x 24"

**Figure 7-B**  
**Regulatory and Guide Signs**





Regulatory signs used in construction and maintenance areas must be the shape and color required by the MUTCD. They must be used as follows.

### **A. Turn Restrictions**

“NO LEFT/RIGHT TURN” signs are used whenever turns cause excessive congestion at intersections during restrictions. They must be placed with a minimum of two (one on the near side and one on the far side of the intersection) for each direction of traffic affected. “EXCEPT BUSES” panels must be attached at the bottom of each sign when turn restrictions affect transit routes to permit buses to turn left, when turns can be made in safety. A panel with hourly restrictions (e.g., 7:00 to 8:30 AM and 4:00 to 6:00 PM Mon-Fri) must be attached when turn restrictions are required only during specific hours.

Mandatory turn signs are used to show motorists when they must turn right or left from a special turning lane separated from the through traffic lane. They must be placed with a minimum of two (one in advance and one at the intersection) for each direction of traffic affected.

### **B. Speed Limits**

“CONSTRUCTION ZONE”/“SPEED LIMIT” combination signs are used to indicate to drivers the reason for reduced speeds. They must be placed with a minimum of one in advance of construction and a minimum of three signs per half mile on arterial and collector streets, for each direction of traffic affected.

“SPEED LIMIT” signs must always be co-mounted with a “CONSTRUCTION ZONE” sign when reducing speed limits in construction areas. The large “CONSTRUCTION ZONE” and “SPEED LIMIT” signs on posts at the side of the street must be used in all arterial street reconstruction areas. At other locations, the small signs on portable supports may be used. Existing conflicting “SPEED LIMIT” signs must be covered or removed.

The “SPEED LIMIT 25” sign is used where the existing pavement has been removed, or traffic is being maintained on temporary detour roads, unpaved shoulders, or on traffic lanes that are severely restricted.

The “SPEED LIMIT 35” sign is used in advance of the “SPEED LIMIT 25” sign when reducing existing speed limits from 40 and 45 miles per hour. Speed limits by State law must not be reduced in increments greater than 10 miles per hour. The “SPEED LIMIT 35” sign is also used for interim speed reduction in construction areas until construction progress requires 25 miles per hour. The “SPEED LIMIT 35” is also used where traffic is being maintained on new asphalt paving projects and in most construction zones on improved streets where restricted traffic is maintained on a reduced number of lanes.

### **C. Street Closures**

The “STREET CLOSED TO THRU TRAFFIC” sign must be used for all complete closures of Major and Collector streets. When in use, the proper “DETOUR ARROW” and detour instructions must be displayed. “STREET CLOSED AHEAD” and “DETOUR AHEAD” signs must be used a



minimum of 300 feet and 600 feet respectively, in advance of all arterial and collector street closures (see Figure 7-M). Mandatory turn lanes approaching street closures must be closed (see Figure 7-N).

The “STREET CLOSED LOCAL TRAFFIC ONLY” sign must be used for all local street closures.

The “ALLEY CLOSED” sign must be used for all alley closures.

The “DETOUR” sign with arrow must be used to mark detour routes when required by the Transportation Engineering Division.

The “OPEN TO LOCAL BUSINESSES” sign is optional where access on major and collector streets that are closed for construction becomes a problem. It is installed on a barricade adjacent to the “STREET CLOSED” sign when requested by the Transportation Engineering Division.

#### **D. Other Regulatory Signs**

“KEEP RIGHT (LEFT)” signs must be used at, or near the start of all channelization except where the “DOUBLE ARROW” warning sign is used. The “KEEP RIGHT” sign must be used on both sides of all intersections where temporary centerline channelization is required.

##### **7.6.1.2 Warning Signs**

Warning signs are used to notify motorists of specific hazards or restrictions in construction and maintenance areas. Within construction zones there may be a variety of temporary roadway conditions such as reduced width, open excavations, or pavement removal. Motorists must be properly alerted well in advance to provide adequate time to react safely to the situation.

All warning signs are provided by the contractor, utility, or other agency. Commonly used signs are illustrated in Figures 7-C and 7-D.

Warning signs used in construction and maintenance areas must be diamond shaped, except as otherwise shown in the warning sign illustrations. They must have a black legend and/or symbol on an orange background. The warning signs illustrated must be used for only those situations indicated by their legend or symbol. Distances such as 500 feet, 1,000 feet, ¼ mile, ½ mile, 1 mile or 2 miles, may be used in place of the word “AHEAD” on advance warning signs, and numerals may be used in place of words (e.g. 2 instead of TWO).

The “ROAD WORK AHEAD” sign must be used in advance of all construction and maintenance areas in addition to other applicable warning signs. Minimum spacing for advance warning signs in advance of channelization should be equal to the taper lengths shown in Table 7.1.

##### **7.6.1.3 Guide Signs**

Guide signs are used to direct motorists on detour routes and provide information in advance of street closures.

All guide signs are provided by the contractor, utility or other agency.

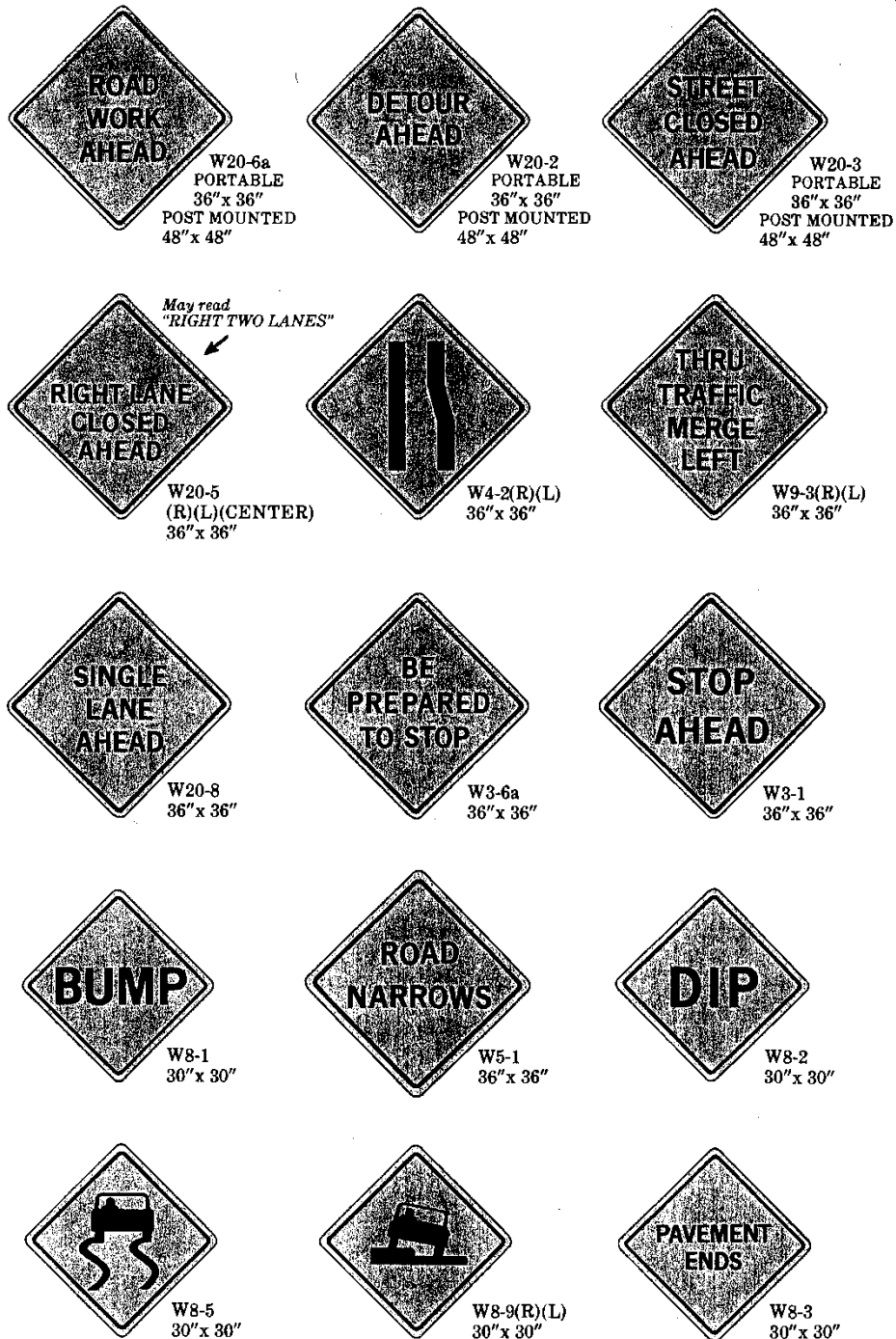
Guide signs used in construction and maintenance areas are generally rectangular. They must have a black legend on an orange background.

Guide signs most frequently used are the “DETOUR” signs and “ARROWS” shown with the “STREET CLOSED” signs in Figure 7-B. The “DETOUR” sign and detour instructions are incorporated into the design of the “STREET CLOSED TO THRU TRAFFIC” sign.

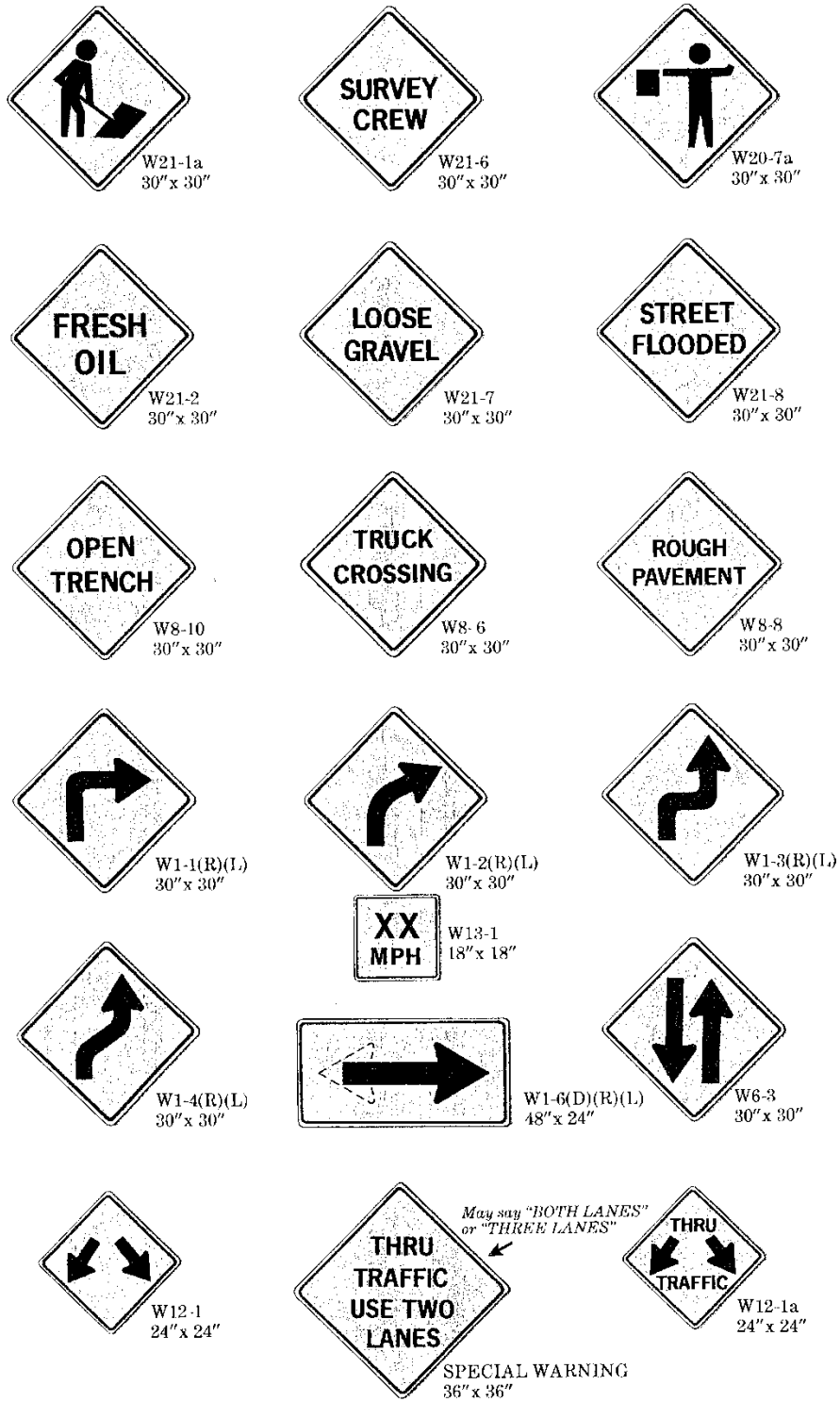
When required, the contractor, utility, or other agency must provide separate “DETOUR” signs, with the appropriate arrow, at locations along a specific detour route, as directed by the Transportation Engineering Division. When required, detailed detour route instructions and/or State and Federal route symbols must also be provided and attached to the detour signs.

(Intentionally left blank)

**Figure 7-C  
Warning Signs**



**Figure 7-D  
Warning Signs**



**Table 7.1**  
**Formulas for Taper Length and**  
**Distance between Devices**

SPEED LIMIT	FORMULA
40 mph or under	$L = \frac{WS^2}{60}$
45 mph or over	$L = WS$

L = Taper Length; W = Width of Lane; S = Posted Speed Limit

SPEED LIMIT (mph)	TAPER LENGTH (L) (feet) **			MAXIMUM DISTANCE BETWEEN DEVICES (feet)	MINIMUM NUMBER OF DEVICES NEEDED
	10' LANE	11' LANE	12' LANE		
25	104	115	125	25*	6
30	150	165	185	30	7
35	204	225	245	35	8
40	267	293	320	40	9
45	450	495	540	45	13
50	500	550	600	50	13
55	550	605	660	55	13

\* Distance between **traffic cones** used for tapers should not exceed 25 feet regardless of speed.

\*\* Advance warning signs should be placed a minimum of Distance (L) in advance of taper.

**Note:** Temporary speed limit reductions from 45 mph down to 35 or 25 mph normally occur prior to introduction of vertical panels or lane reductions. Therefore, the use of 45 mph, hence, 540-foot tapers based on a 12-foot lane, is not typically necessary. The use of 35 mph taper lengths is likely more appropriate. Caution should be used in applying a 25 mph taper, unless experience dictates that 25 mph operating speeds are expected.

### 7.6.2 Barricades and Channelizing Devices

Barricades and channelizing devices are the most important part of temporary traffic control in construction and maintenance areas. They are used to warn and alert motorists of temporary restrictions and to guide motorists and pedestrians through restricted areas. They are not intended to be physical barriers. Barricades and channelizing devices should always be used in groups to warn and guide traffic.

Rope, flagging and woven plastic tape may be used between barricades and channelizing devices in construction areas to provide additional guidance and security. In some major construction areas and in areas with substantial pedestrian traffic, the use of plastic or metal construction fencing may be necessary for maximum security.

Barricades and channelizing devices used to guide motorists must provide a smooth, gradual transition when moving traffic from one lane to another, onto a bypass detour, or when reducing the width of the street. This smooth, gradual transition is referred to as the “taper length”. The desirable taper length formulas, calculated taper lengths, and spacing of devices for tapers are shown on Table 7.1.

Minimum desirable taper lengths apply to streets of relatively flat grades and straight alignments. Adjustments may be desirable to provide adequate sight distance on the approach to channelization and to accommodate cross streets and adjacent driveways. Caution should be exercised when increasing taper lengths beyond what is required in this chapter or the MUTCD, as this will lengthen the construction zone and unnecessarily impact nearby businesses and residents.

When more than one lane of traffic is diverted, a tangent length of channelization equal to twice the taper length should be used between the taper for each lane closed (see Figure 7-Y). A tangent distance of one half the taper length should be used between tapers when diverting a single lane to an alternate alignment (see Figure 7-AA). Spacing for devices used in tangent areas between tapers should be the same as the spacing for devices used in the adjacent tapers.

Barricades and channelizing devices are also used to protect workers when working in the street, and to guide and protect pedestrians. They should be constructed in a substantial manner for protection. However, devices should be designed so as not to cause severe damage to vehicles if hit.

Barricades and channelizing devices must be kept clean and fresh appearing at all times.

Typical uniform applications of barricades and channelizing devices are shown in the barricade illustrations included in this chapter. Situations not illustrated must be handled in conformance with the general methods set forth.

#### **7.6.2.1 Barricades**

Barricades used in the City of Chandler must be Type I, II or III (see Figure 7-E). Markings for all barricade panels must be alternate orange and white stripes sloping down at a 45 degree angle to the side on which traffic is to pass. Both stripes (orange and white) must be reflectorized with smooth surface weatherproof reflectorized sheeting.

All barricades must be constructed of suitable materials in a professional workmanlike manner to the dimensions shown in Figure 7-E. Barricade supports must be substantial and must be galvanized or aluminum.

Type I and II barricades are intended for use where traffic is maintained through construction and maintenance areas. They are used to delineate hazards in or near the street or sidewalk, to close local and collector streets, to close sidewalks and alleys, and to channel traffic. When used to delineate hazards parallel to traffic, spacing should not exceed 75 feet. When used to close streets, sidewalks and alleys, spacing should not exceed 5 feet.

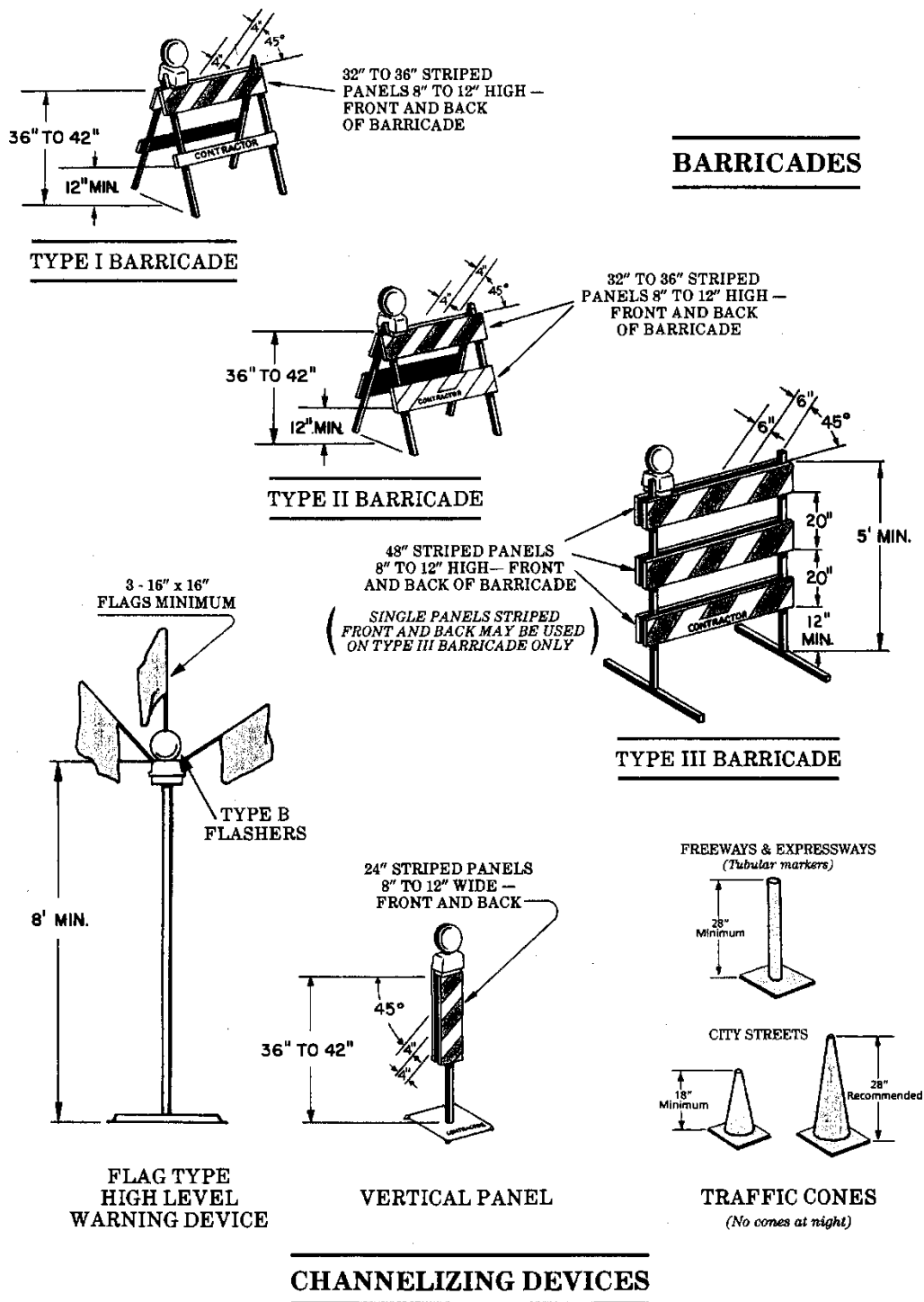
Type I and II barricades used to channel traffic, must be placed on a taper to guide motorists past hazards. Taper lengths and barricade spacing should be as shown in Table 7.1.

Type III barricades are used for complete street closures of arterial streets when they are under construction. They must be placed with a minimum of one on each side of the “STREET CLOSED TO THRU TRAFFIC” sign, and one centered on the back of the sign. Additional Type III barricades must be used as required to close the street to through traffic.

(Intentionally left blank)



**Figure 7-E**  
**Barricades and Channelizing Devices**



Barricades used in the right-of-way during hours of darkness must have an approved barricade warning light attached and in operation. The warning light must be mounted above

the top panel on the end of the barricade closest to traffic. Type A flashing warning lights must be used to delineate hazards and close streets, sidewalks, and alleys. Type C steady burn warning lights must be used in a series to channel traffic, and guide traffic through construction areas.

Type I, II and III barricades must have the using contractor, utility or other agency's name placed near the bottom of the lowest panel as illustrated in Figure 7-E. The letters must be black on a white background, and not less than 1-inch, nor more than 2 inches in height.

#### **7.6.2.2 Barricade Warning Lights**

Barricade warning lights are alerting devices used with other traffic control devices for advanced warning of unexpected restrictions, and to guide motorists when entering and driving through restricted areas. They must be mounted on all signs, barricades and channelizing devices, as specified in this chapter, when used in the right-of-way during hours of darkness. Barricade warning lights must be in operation during hours of darkness.

Barricade warning lights are portable, battery operated, lens directed enclosed lights, commonly referred to as either Type A low intensity flashing warning lights, Type B high intensity flashing warning lights or Type C steady burn warning lights. Warning lights must have 7-inch diameter lenses that emit yellow light. They must be in accordance with the current Institute of Transportation Engineers' purchase specifications for flashing and steady-burn warning lights, as required in the MUTCD.

Barricade warning lights must be maintained so that the light provides adequate advance warning to alert and guide motorists and pedestrians in restricted areas.

Type A low intensity flashing warning lights must be used on all signs that are mounted on portable supports and on all barricades and vertical panel channelizing devices used to mark hazards and closed streets. Type A warning lights must not be used on devices intended to guide traffic.

Type B high intensity flashing warning lights must be used on advance warning signs for major street construction when mounted on streetside supports and on all flag type high level warning devices when used at night. Type B warning lights mounted on portable supports and on flag type high level warning devices must have the battery remotely mounted in the base at ground level to provide additional stability.

Type C steady burn warning lights must be used on all barricades and vertical panel channelizing devices used to guide traffic, form tapers, and delineate center lines, lane lines, and the edge of the traveled way. Type C warning lights may be used on devices to mark hazards, but they are generally less effective than flashing lights for this purpose.

#### **7.6.2.3 Channelizing Devices**

Channelizing devices include traffic cones, vertical panel channelizing devices, drums, high level warning devices and pavement markings.

### **A. Traffic Cones/Poly Tubes**

Traffic cones are effective for daytime channelization of traffic and to delineate minor maintenance areas. Traffic cones are versatile because they will not damage vehicles if hit, and can be set up and removed quickly. When traffic cones are used, it is necessary to check them often, as they are frequently disturbed (moved) by vehicles. Cones are not suitable for nighttime use.

Traffic cones may be conical or tubular devices, generally with square, weighted bases (see Figure 7-E). The predominant color of both devices must be orange or fluorescent red-orange. For use on all streets, conical devices must be a minimum of 18 inches high and tubular devices must be a minimum of 28 inches high. On high volume arterial streets where additional traffic guidance is needed and the smaller devices are frequently disturbed by vehicles, conical devices must be a minimum of 28 inches high and tubular devices must be a minimum of 42 inches high.

Traffic cones are used to channel traffic, divide opposing traffic lanes, divide traffic lanes when two or more lanes are open in the same direction, and delineate minor maintenance operations in the street. When traffic cones are used to divide traffic lanes or delineate minor maintenance operations, spacing should not exceed 50 feet.

When traffic cones are used to channel traffic, they must be placed on a taper to guide motorists past hazards. Taper lengths should be as shown in Table 7.1. Because cones are smaller and have less target value than barricades, spacing between cones used to channel traffic should not exceed 25 feet, regardless of speed.

### **B. Vertical Panel Channelizing Devices**

Vertical panel channelizing devices are effective for 24 hour channelization. They are used in place of traffic cones for channelization during hours of darkness. They are versatile because they have much more target value than pavement markings, are portable, light weight and use less street width than barricades. Professional experience indicates that vertical panels properly placed dominate existing pavement markings, provide positive guidance, and permit existing pavement markings to remain on short term projects without driver confusion.

Markings for vertical panel channelizing devices must be alternate orange and white stripes sloping down at a 45-degree angle to the side on which traffic must pass. When used to divide two traffic lanes in the same direction, the stripes must slope down to the side on which traffic is being diverted (see Figure 7-Y). Both stripes (orange and white) must be reflectorized with smooth surface weatherproof reflectorized sheeting.

Vertical panel channelizing devices must be constructed of suitable material in a professional workmanlike manner to the dimensions shown in Figure 7-E. The base and panel support should be substantial and designed to resist overturning. Because the base can be an obstacle to traffic when overturned, the base and support should be designed to minimize damage to a vehicle if hit.

Vertical panel channelizing devices are used to channel traffic, divide opposing lanes of traffic, divide traffic lanes when two or more lanes are maintained open in the same direction and in place of barricades, where space is limited. When vertical panels are used to channel traffic, they must be placed on a taper to guide motorists past hazards. Taper lengths and vertical panel spacing should be as shown in Table 7.1. When vertical panel channelizing devices are used in place of barricades to delineate hazards parallel to traffic, spacing should not exceed 50 feet. When used to divide opposing lanes of traffic or divide two or more lanes traveling in the same direction, spacing should not exceed 75 feet for short distances and 150 feet for extended distances.

Vertical panel channelizing devices used in the right-of-way during hours of darkness must have an approved barricade warning light attached and in operation. The warning light must be mounted above the marked panel. Type C steady burn warning lights must be used in a series to channel traffic, to divide opposing traffic, separate traffic lanes and guide traffic through construction areas. Type A flashing warning lights must be used to delineate hazards.

### **C. Drums**

Drums are most commonly used to channelize or delineate traffic flow, but may also be used in groups to mark specific hazards. Drums are highly visible and have good target value, give the appearance of being formidable obstacles and therefore, command the respect of drivers. Their primary disadvantage is their size, which makes them difficult to use on City streets with narrow traffic lanes. Drum spacing used to delineate hazards, close streets, and channel traffic, must be the same as specified for Type I and Type II barricades. Drums are portable enough to be shifted from place to place in order to accommodate changing conditions, but are generally used in situations where they will remain in place for a prolonged period of time. When drums are placed in the roadway, appropriate advance warning signs must be used.

Drums used for traffic warning or channelization must be approximately 36 inches in height and a minimum of 18 inches in diameter. Drums must be made of plastic or other flexible material that will not cause serious damage if struck. Use of metal drums is prohibited. Markings on drums must be horizontal, circumferential, orange, and white alternating stripes 4 inches to 8 inches wide. Both stripes must be reflectorized with smooth-surfaced weatherproof sheeting, which will display the same approximate size, shape and color day and night. There must be at least two orange and two white stripes on each drum. If there are non-reflectorized spaces between the horizontal orange and white stripes, they must be no more than 2 inches wide.

Drums should not be more than 20 percent filled with sand, water, or any material that would increase the obstacle nature of drums. Water must not be used in periods susceptible to freezing. Open drums should have drain holes in the bottom so water will not collect. During hours of darkness, a flashing warning light must be placed on each drum used to mark

hazards and steady burn warning lights should be placed on drums used in a series for traffic channelization.

Arrow signs (W1-6) or vertical panels mounted above drums may be used to supplement drum delineation.

### **7.6.3 High Level Warning Devices**

High level warning devices are used to alert the motorist of an obstruction in the street. Design of high level devices is such that they can be seen over the top of preceding vehicles. This height feature is particularly effective in diverting traffic around obstructions.

High level warning devices are required for all work in the street such as: new construction, pavement patching, manhole work, surveying, cranes, excavations, etc. High level warning devices may be attached to a vehicle located at, or placed in advance of, the obstruction. On fixed location projects, required high level warning devices should be positioned with or behind the channelization, and in the center of the area closed, except advance warning arrow panels. Arrow panels used on fixed location projects should be placed on the shoulder or in the parking lane at the beginning of the taper, when possible.

High level warning devices used in the City of Chandler include advance warning arrow panels, flags, and rotating flashers or strobe lights.

#### **7.6.3.1 Advance Warning Arrow Panels**

Advance warning flashing or sequencing arrow panels, incorporating a number of sealed beam lamps designed to flash directional arrows or chevrons, should be used in lieu of other types of high level warning devices when possible. Arrow panels provide additional advance warning and directional information to assist in diverting traffic, which is especially effective under high density traffic conditions and at night.

Advance warning arrow panels must be legible to drivers at a distance of one-half mile on local or collector streets with a posted speed of 35 mph or less, and they must be legible to drivers at a distance of three-fourths mile on arterial streets. Minimum legibility distances are those at which the arrow panel message can be comprehended by a driver on a sunny day or clear night.

The arrow panel should be positioned on the shoulder or in the parking lane at the beginning of the taper, when possible. When width is restricted, the arrow panel should be positioned behind the required channelization, near the start of the taper. The arrow panel must be in place throughout the restricted period.

Vehicles used to display arrow panels should be equipped with an impact-attenuating device whenever possible, to provide additional safety for works and motorists. While impact attenuators are optional, their use can help prevent serious damage to vehicles, equipment and workers at construction sites, which can make their use cost effective.

Generally, arrow panels should not be used for shoulder or roadside work activities, nor should they be used on two lane highways, because the panels can cause unnecessary lane changing.

Arrow panels provide additional advance warning and directional information when traffic must change lanes and should be used in lieu of other high level warning devices when possible.

### **7.6.3.2 Flag Type High Level Warning Devices**

Flag-type high level warning devices must display three or more flags supported so that the lowest point of all three flags is 8 feet or more above the street (see Figure 7-E). The flags must be orange or fluorescent red-orange in color, and 16 inches square or larger. The flag support and base must be substantial to resist overturning by wind. The flag support and base must be galvanized, aluminum or white in color.

During hours of darkness, each flag type high level warning devices must be equipped with a minimum of one Type B high intensity flashing warning light with lens mounted more than 8 feet above the street.

One flag-type, high level warning device is required for each direction traffic is affected. The devices must be placed with or behind the required channelization in the center of the area closed. Additional flag type, high level warning devices may be used for sign supports. They must be located at the location required by the sign legend.

### **7.6.3.3 Rotating Flashers and Strobe Lights**

Electrically operated rotating sealed beam or halogen lamp flashers, or strobe light flashers, may be used in lieu of or in addition to flag-type, high level warning devices.

Rotating sealed beam flashers must consist of one or more sealed beam units at least 4 inches in diameter, rated at a minimum of 30,000 candlepower each. They must emit a yellow light with a flash rate of 70 to 110 flashes per minute.

Halogen lamp flashers must consist of one or more halogen lamps with a minimum rating of 50 watts generating 50,000 candlepower each, reflected in a rotating or alternating pattern by high quality parabolic reflectors. They must emit a yellow light with a flash rate of 70 to 120 flashes per minute.

Strobe light flashers must be rated at a minimum of 1,000,000 candlepower at the bulb. They must emit a yellow light with a flash rate of 80 to 120 flashes per minute.

Rotating flashers or strobe lights, must be mounted on a vehicle or other substantial support. When possible, they must be mounted at a minimum height of 8 feet above the street.

The vehicle or other support, with flashers in operation, must be positioned behind the required channelization and in the center of the area closed throughout the restricted period, except when used on a moving service vehicle.

Use of rotating flashers or strobe light type, high level warning devices is particularly desirable during hours of darkness, and they should be used in lieu of the flag type, high level warning device with the flasher attached, whenever possible.

#### **7.6.4 Pavement Markings**

When barricading is taking place on the base course of asphalt, the use of striping may be used in place of vertical panels to minimize the visual impact of the barricading. This could also apply to existing surface course where set-ups are three weeks or more in duration, but this would require a slurry or micro seal to be applied immediately after construction to cover up any obliteration and to prevent any ghosting of the old striping.

Temporary markings may be used to guide traffic in construction and maintenance areas when clean, hard surfaced street or detour roadway surfaces exist. Temporary pavement markings must be kept clean at all times. Normally, they should be used in combination with signs, barricades and channelizing devices. Existing pavement markings that conflict with the vehicle path indicated by temporary markings must be removed or obliterated as required in this chapter. Temporary markings must be removed and permanent markings replaced upon project completion.

Reflectorized paint lines, pavement marking tape or raised pavement markers may be used for temporary traffic control when approved by the Transportation Engineering Division. They are generally used on paved detours, and on major street construction between completion of asphalt base and finish course. When used on major street construction, temporary painted left turn lanes must be provided at all signalized intersections. Reflectorized paint lines must be applied with a suitable paint striping machine using City of Chandler specifications, or equal, traffic paint and reflective glass beads. Paint lines must have a minimum wet film thickness of 15 mils with 6 pounds of glass beads applied per gallon of paint. Reflectorized pavement marking tape specifically manufactured for pavement marking use may be used in place of paint lines. Pavement marking tape must be durable and have the appearance and reflectivity of paint lines. Application of short pieces of pavement marking tape to form dashed lines in lieu of pavement striping is not acceptable.

Centerline markings must be two, 4-inch wide yellow lines with a 4-inch space between. Lane line markings must be 4 inches wide, placed with 10 lineal feet of line and 30 lineal feet of space to form the lane line pattern. Other markings for barrier lines, edge lines, crosswalks and school zones, may be necessary to complete temporary marking installations. Edge lines must be 4-inch wide continuous white lines. Barrier lines for mandatory turn lanes, pavement edge tapers and lane transition must be 8-inch wide white lines. Stop bars must be 18-inch wide solid white lines. Crosswalk lines must be 12-inch wide solid white lines.

Raised reflectorized pavement markers may be used in lieu of paint or tape markings. They should be used to supplement paint and tape pavement markings in unlighted areas, on lane changes and on detours. Centerline markers must be yellow. Lane line and edge line markers must be white. Spacing between markers used in lieu of paint or tape center and



edge lines must not exceed 10 lineal feet on straight alignments and 5 lineal feet on curves. Lane lines must be groups of three markers spaced 5 lineal feet apart with a 15 lineal foot space between groups on straight alignments and a 10 lineal foot space between groups on curves. Spacing between markers used to supplement paint and tape center, lane and edge lines must not exceed 40 lineal feet on straight alignments and 20 lineal feet on curves.

### **7.6.5 Police Officers and Flaggers**

Police officers and flaggers perform a very important function as the human element in the temporary traffic control system. Other devices alter, advise, and guide motorists and pedestrians, but cannot respond to the diverse traffic conditions that may occur during major restrictions. Police officers and flaggers can visually assess traffic conditions and respond accordingly. While flaggers are limited by the *Manual on Uniform Traffic Control Devices* to flagging operations that can be accomplished from the edge of the traveled way, police officers are authorized to direct traffic as required. They can operate traffic signals, control multiple lanes of traffic, and permit specialized lane movements. They can also assist pedestrians and enforce traffic restrictions. Police officers and flaggers that are alert, visible, and accommodating can be a valuable public relations asset.

The use of police officers is required when three lanes of traffic are reduced to one within 300 feet of a signalized intersection. Exceptions may be made at minor signalized intersections at the discretion of the City Transportation Engineer, or his/her designee.

Police officers are required for manual control of traffic at signalized intersections and for flagging operations on multiple lane streets. One police officer at each signalized intersection affected is generally adequate, but during flagging operations and when construction equipment creates vision restrictions, two or more officers may be required.

Police officers or flaggers may be used for manual control of traffic at non-signalized locations, where (i) equipment is intermittently blocking or crossing a traffic lane, or (ii) only one traffic lane is available for two directions of traffic. When used in single lane two-way traffic situations, two police officers or flaggers (one for each direction) are required, except when approved temporary traffic signals are used.

#### **7.6.5.1 Police Officers**

The use of on-duty City of Chandler police officers is limited to short-term assistance during emergency situations. Contractors, utilities, and other agencies must use uniformed extra-duty police officers when officers are required for traffic control. The use of City of Chandler police officers to provide traffic control and/or monitor barricade sites within the City is preferred and City of Chandler officers must be given first priority in filling these jobs.

To schedule extra-duty officers for traffic control during construction or maintenance operations visit <https://odm.officertrak.com/Chandler-AZ-PD> or call 1-877-636-8300. A minimum of 24 hours advance notice is required.

### 7.6.5.2 **Flaggers**

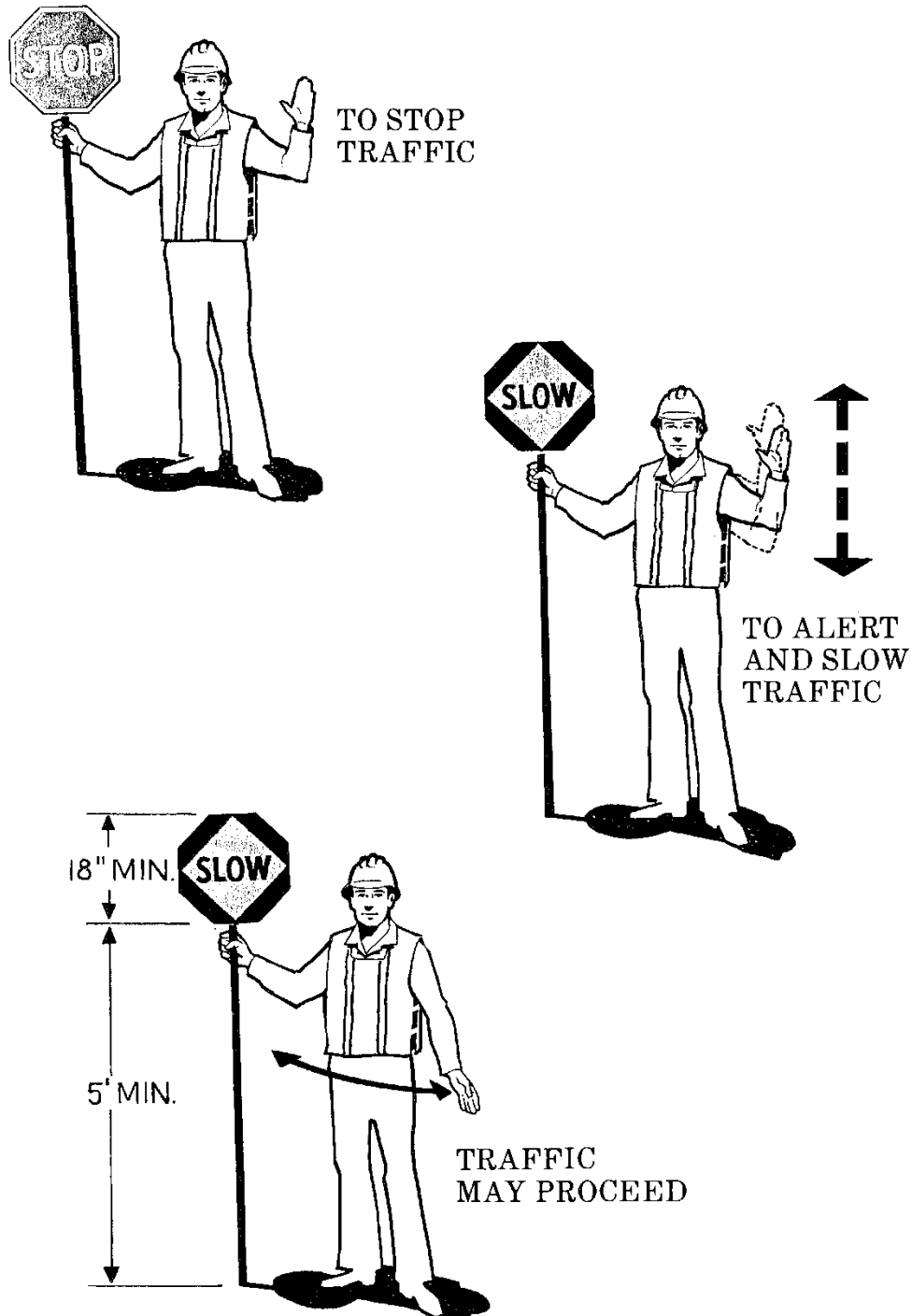
Flaggers should be alert, courteous, neat, and possess a sense of responsibility for the safety of the public and work crews. Flaggers must wear an orange or fluorescent red-orange vest and hard hat and use a “STOP/SLOW” sign to control traffic. The “STOP/SLOW” sign must be 24 inches in diameter with 6-inch series C letters. The “STOP” face must have a red octagon background with white letters and border. The “SLOW” face must have an orange diamond background with black letters and border. The sign must be mounted on a suitable staff to support the sign 5 feet from the ground when in use.

Flagging procedures are illustrated in Figure 7-F. Flaggers must be stationed at a readily visible location on the shoulder or behind channelization in advance of the restriction. Flagger stations must be marked with a high level warning device. “FLAGGER AHEAD” AND “BE PREPARED TO STOP” signs must be used in advance of each station. At no time should a Flagger be allowed to stand in the traveled part of the roadway or cross a traffic lane to stop more than one lane of traffic.

During the hours of darkness, each Flagger station must be illuminated. All traffic control devices including the STOP/SLOW sign and the flagger’s vest must be reflectorized. Signs, barricades and channelization in advance of each Flagger station must have barricade warning lights attached and in operation.

(Intentionally left blank)

**Figure 7-F**  
**Flagging Procedures**



**7.6.6 Temporary Traffic Signals**

A temporary traffic signal system may be used to control vehicular traffic movements at construction or maintenance work areas when a traffic engineering study indicates the

desirability to do so. Each use must be specifically approved by the Transportation Engineering Division. All traffic signal control equipment must meet the applicable standards and specifications prescribed in Parts 4 and 6 of the MUTCD.

Contractors, utilities, or other agencies must prepare a detailed traffic control plan showing the location, use, timing and hours of operation at each location for approval prior to implementation. Signal controller phasing and timing must be pre-approved by the Transportation Engineering Division. Only extra-duty police officers may manually control temporary traffic signals unless otherwise approved by the Transportation Engineering Division. "TRAFFIC SIGNAL AHEAD" (W3-3) signs must be placed in advance of all approaches to temporary traffic signals.

### **7.6.7 Portable Barriers**

Portable barriers are usually heavy pre-cast reinforced concrete units commonly referred to as "Jersey barriers." These devices are approximately 36 inches high and taper from a wide base to a narrow top. They are designed to be physical barriers placed parallel to traffic lanes to prevent vehicles from leaving the traveled way, and to protect workers. They are generally used to guide traffic on curved detour alignments, replace bridge rails during reconstruction, and separate traffic from construction areas on long term, fixed location projects. They may also be used to separate opposing traffic lanes.

Portable barriers may only be used in combination with the required signs, barricades and channelizing devices. Barriers may serve the additional function of channelizing traffic. When serving this function, barriers must be light in color and equipped with vertical panel markings and barricade warning lights. The first two warning lights at the start of a continuous barrier must be Type B flashing warning lights. All other warning lights must be Type C steady burn warning lights. Spacing for barricade warning lights and vertical panel markings, will be as required for vertical panel channelizing devices in this chapter.

The traffic approach ends of all portable barriers must be protected from vehicle impact by the use of impact-attenuators or flaring the ends away from the traveled way. When space permits, approach ends must be flared at a 45-degree angle to a minimum of 10 feet from the traveled way. When space does not permit, barrier ends must be protected with impact-attenuators as required in the MUTCD.

Water barriers may be used at the discretion of the City Transportation Engineer.

## **7.7 PEDESTRIAN WALKWAYS AND CONSTRUCTION FENCES**

Each and every crosswalk and pedestrian walking area, whether paved or earth, must be maintained by the contractor, utility or other agency at all times, unless otherwise provided for in this chapter, the approved Road Restrictions and Closure permit, or during emergency conditions. All pedestrian facilities must comply with the Americans with Disabilities Act (ADA) at all times.

Proper planning for pedestrians through and along construction areas is as important as roadway planning. Pedestrian consideration, including access to bus stop locations and crosswalks, must be an integral part of each project. When construction requires closing existing crosswalks and walkways, the Contractor should provide temporary walkways and direct pedestrians to the safest, most convenient route possible. All walkways must be clearly identified and wheelchair usable, protected from motor vehicle traffic, and free of pedestrian hazards (holes, debris, dust, mud, etc.). Pedestrian protection and temporary walkways may use any of the traffic control devices, including barricades, cones, signs, etc., approved herein (see Figure 7-G), unless a covered walkway or construction fence is required. All traffic control devices must be placed so as to leave at least a 60-inch accessible walkway past the sign (or 48-inch with a 60 x 60-inch passing space at least every 200 feet allowing individuals with wheelchairs to pass). The only exception will be on the rare occasion when a walkway is totally closed to everyone for safety reasons (no open business beyond and all bus stops relocated beyond).

Temporary walkways, where possible, must be maintained on part of the existing sidewalk, behind the existing sidewalk, or in the adjacent parking lane where available. The “PEDESTRIAN” sign with appropriate direction arrow must be used to direct pedestrians to the alternate walkway when the walkway is maintained on the same side of the street.

Anybody requesting complete or partial walkway closures on one side of the street must first diligently try to accommodate pedestrians on accessible alternative paths on the same side of the street. If that cannot physically be done, and work procedures require that pedestrians be rerouted for protection, the Contractor needs to make sure that the alternative path is fully accessible.

During approved complete sidewalk closures, “SIDEWALK CLOSED USE OTHER SIDE” signs must be provided at the nearest crosswalk or intersection to each end of the closure. Where the closure occurs at the corner of an intersection, these signs must be erected on the corners across the street from the closure.

“SIDEWALK CLOSED” signs must be used at the beginning of the actual sidewalk closure.

The “SIDEWALK CLOSED AHEAD” sign will be used to notify pedestrians that a walkway is closed ahead. Special care needs to be taken in sign placement to make sure that the sign is prominently visible to pedestrians yet keeps open at least a 60-inch accessible path past the sign (or 48-inch with a 60 x 60-inch passing space at least every 200 feet allowing individuals with wheelchairs to pass). Additionally, care needs to be taken to assure that adequate maneuvering room exists at the sign to enable disabled users to make an informed decision as to whether it is best to cross to the other side or continue on the accessible path beyond the barricade to their destination.

During construction or demolition of buildings adjacent to sidewalks and other pedestrian walking areas, a covered walkway must be provided for pedestrian protection when the walkway is less than one-half of the height of the exterior wall from the building. When the

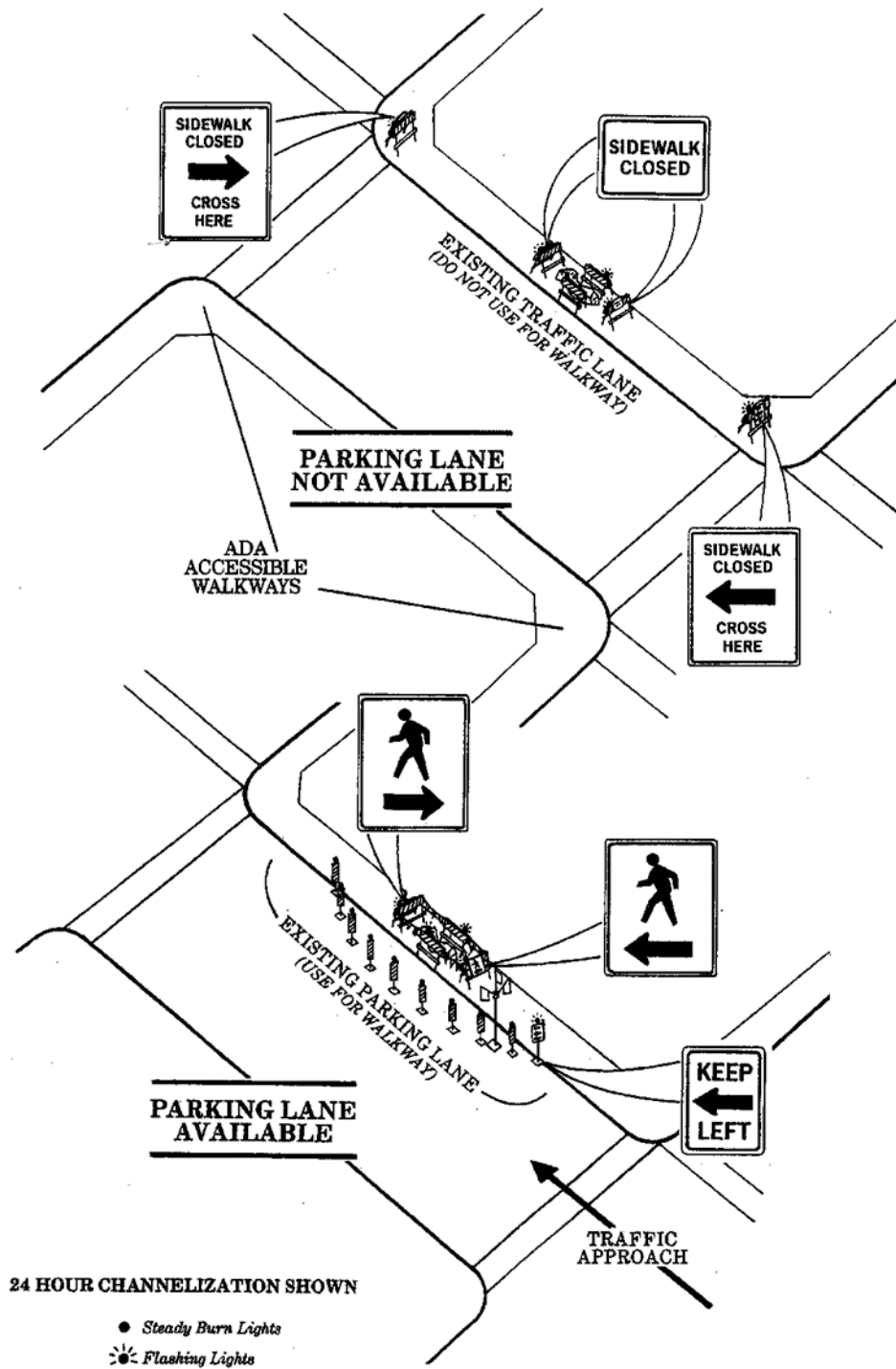
walkway is more than one-half of the height of the exterior wall from the building, a construction fence must be provided. A fence is always required at all construction and demolition sites prior to any work.

The Contractor must submit a professionally prepared traffic control and walkway plan to the Transportation Engineering Division for approval, before beginning building construction or demolition work that affects streets and sidewalks. All covered pedestrian walkways and construction fences must be painted white or other approved light color except where hazard striping is required. They must be maintained in good condition, clean and fresh appearing at all times. Damaged walkways and fences must be repaired by the Contractor immediately.

No loading or unloading of material or staging or stopping of vehicles will be allowed on the street side of walkways and fences, without a Road Restrictions and Closures permit. Gates for access to the construction site must not swing into the street or pedestrian walkways. Access to fire hydrants, traffic signal control boxes, manholes, and other utilities must be provided at all times.

(Intentionally left blank)

Figure 7-G  
Sidewalk Closures





### **7.7.1 Covered Pedestrian Walkways**

Covered walkways must be substantially constructed of suitable material to support the loads to be imposed upon the structure. Minimum design requirements for the floor and roof must be 100 pounds per square foot live load, uniformly loaded and 200 pounds per square foot concentrated load.

The clear walking area must be at least 5 feet wide and 8 feet high. The walking surface must be paved or covered with slip resistant plywood or wood planking. Ramps must be provided for wheel chair use.

The building side of the walkway must be built of tight boards or plywood, except where chain link sign distance panels are required. The roof must be tightly boarded. A 3-foot high enclosure and a 4-foot high railing must be attached on the street side between walkway entrances. All interior surfaces of the walkway must be smooth and free of protruding nails and splinters. The covered area of the walkway including entrances, must be brightly illuminated during hours of darkness with 110 volt, 100 watt electric lamps in vandal resistant fixtures mounted on 30-foot centers, along the inside of the back wall near the roof line.

Each walkway must be inspected daily and maintained clean and free of dirt, debris and hazard at all times. Covered walkways located in the street must include the following traffic warning and pedestrian protection devices (see Figure 7-H).

#### **A. High Level Warning Board**

A high level warning board 2 feet high and width equal to that of the walkway mounted above the walkway on all traffic approaches. The warning board must be striped with 45-degree angle 12-inch orange and white hazard markings, sloping down toward the side on which traffic must pass. Two 110 volt, 75 watt flashing yellow lights in vandal resistant fixtures must be mounted on the warning board, one on the lower right and one on the lower left corner.

#### **B. Fixed Handrail**

The traffic approach end of the walkway at mid-block locations must have a fixed handrail extending from the curb to the traffic side of the walkway. The area from rail to pavement must be covered and striped with 45-degree angle 12-inch orange and white hazard markings sloping down toward the side on which traffic must pass. A minimum of three 100 volt, 75 watt steady burning yellow lights in vandal resistant fixtures must be mounted equally spaced on the striped area at railing height.

#### **C. Clearance Lights**

Steady burning 110 volt, 75 watt yellow clearance lights in vandal resistant fixtures mounted on 30-foot centers along the traffic side of the walkway, when the walkway is in the street, on the curb and within 18 inches of the back of the curb. They must be installed at railing height.

#### **D. Bumper Guard Rail**

A continuous bumper guard rail consisting of one, 2-inch by 16-inch board must be mounted on the street side of the structure at a height of 10 inches from the pavement to the bottom of the rail.

#### **7.7.2 Construction Fences**

Construction fences located adjacent to a required pedestrian walkway, separating pedestrians from construction or demolition work, must be 8 feet high and substantially constructed of tight boards or plywood, except where chain link sight distance panels are required. Construction fences at locations where the walkway is more than the full height of the exterior wall from the building, or the adjacent walkway has been closed to pedestrians, may be constructed entirely of chain link fencing 8 feet high. Construction fences located in the street must include the following traffic warning devices (see Figure 7-1):

##### **A. Hazard Markings**

45-degree angle 3-inch orange and white hazard markings sloping down toward the side on which traffic must pass, at all traffic approaches. The marked area must extend from the pavement to a minimum of 8 feet above the pavement, except as required for sight distance panels.

##### **B. Flashing Yellow Lights**

Two rows of 110-volt, 75-watt flashing yellow lights in vandal resistant fixtures (one row 3.5 feet from pavement and 1 to 8 feet minimum from pavement) with not less than two flashers per row mounted on 8-foot maximum centers along with the hazard markings, on all traffic approaches.

##### **C. Yellow Clearance Lights**

Steady burning 110-volt, 75-watt yellow clearance lights in vandal resistant fixtures mounted on 30-foot centers along the traffic side of all fences in the street, on the curb, and within 18 inches of the back of the curb. They must be mounted 3.5 feet from the pavement.

##### **D. Pedestrians Prohibited Signs**

“PEDESTRIANS PROHIBITED THIS SIDE OF STREET”, signs on the fence opposite all crosswalks, and at the end of all existing walkways, marked or unmarked, when the construction fence closes existing sidewalks or walkways.

#### **7.7.3 Sight Distance Requirements**

Covered pedestrian walkways and construction fences installed at street intersections must be constructed to provide a minimum 45-foot sight distance triangle when possible. If the walkway or fence cannot be constructed along the hypotenuse of the triangle, chain link fence panels must be installed to provide the required sight distance. The chain link fence panels must be a minimum of 4 feet high installed with the bottom 3 feet above the existing pavement. This sight distance must be maintained clear of all temporary buildings, building materials, equipment, debris, and the like, at all times. Sight distance panels must also be

provided for 15 feet on each side of all vehicle access gates in construction fences adjacent to walkways and traffic lanes.

Where the above sight distance panels conflict with the required hazard markings on traffic approach ends of construction fences, the hazard markings and yellow flashing lights must be provided above and below the panels. When covered pedestrian walkways or construction fences conflict with the normal operation and/or visibility of existing traffic signal equipment (pedestrian signals, traffic signal heads, controllers, etc.) and/or traffic signs, arrangements must be made for relocation as provided for in Section 7.5 of this chapter.

(Intentionally left blank)

**Figure 7-H**  
**Covered Pedestrian Walkway**

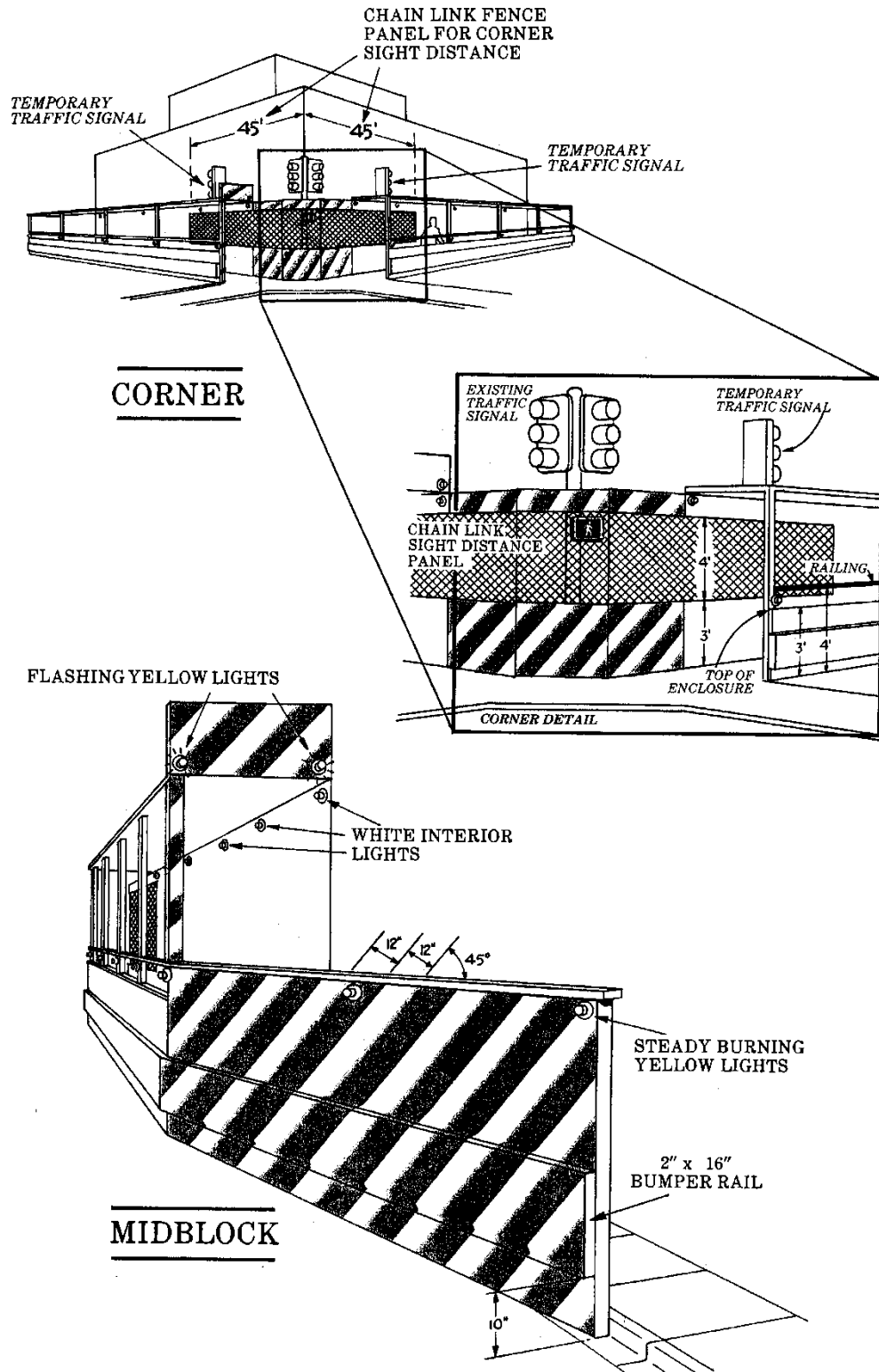
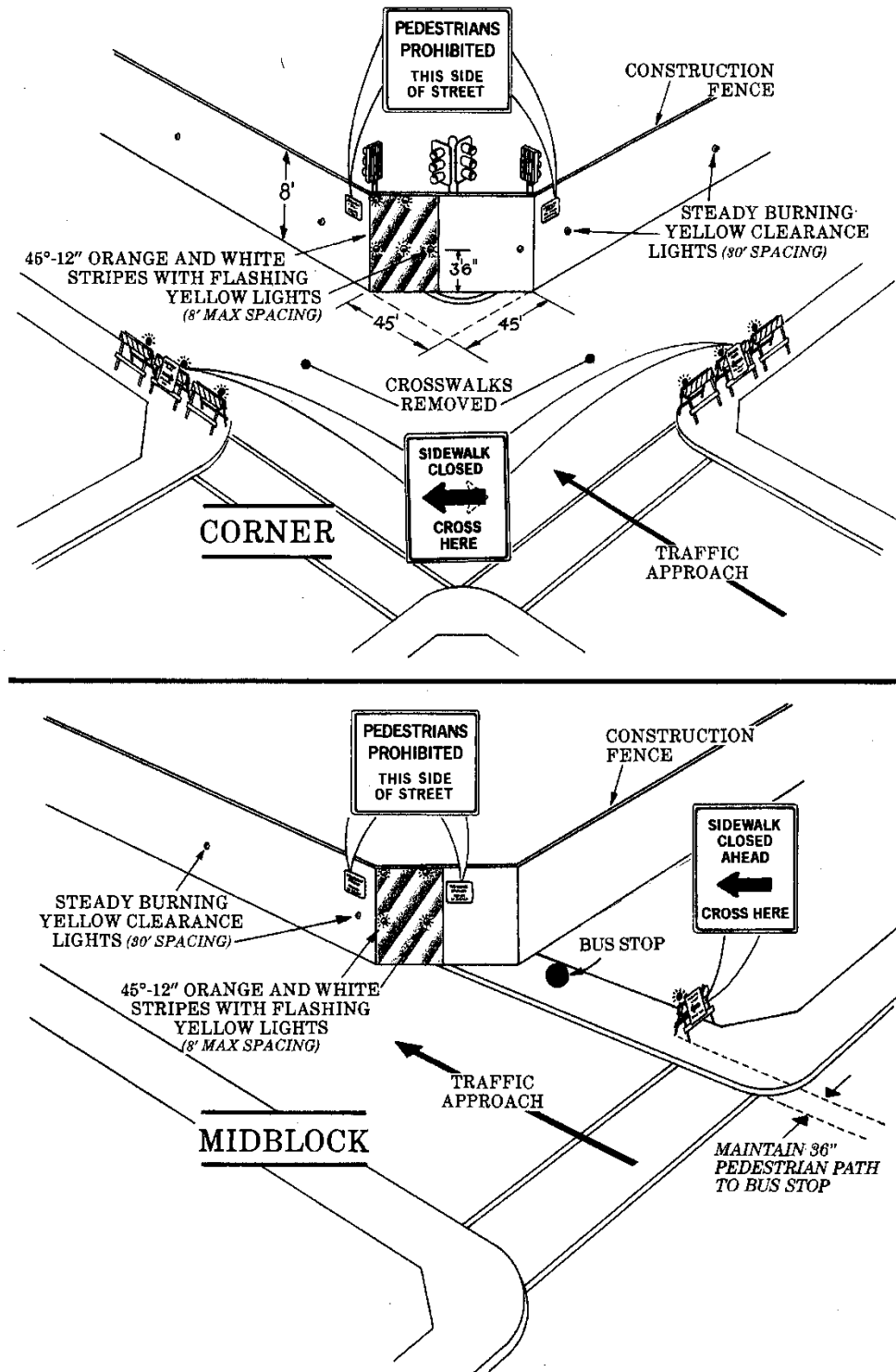


Figure 7-1  
Construction Fences



## 7.8 SURVEYORS

The nature of urban survey work is potentially hazardous. The surveyor, as a pedestrian in the street, may be obscured from the motorist's vision by the presence of a single car. The higher the traffic volume, the greater the chance of a mishap.

Surveying is not permitted on arterial or collector streets during the peak traffic hours, except when such work is in areas that are under construction and the contract special provisions permit restrictions, or with the prior approval of the Transportation Engineering Division.

Road Restrictions and Closure permits to restrict traffic for surveying on streets, other than those under construction, are requested as provided for in Section 7.3 of this chapter. Traffic must be controlled as provided for in Section 7.4 of this chapter. When surveyors are working in areas that are under construction, the traffic regulations applying to the contractor, utility or other agency must also be applicable to the surveyor. All traffic restrictions in construction areas must be coordinated with the contractor, utility, or other agency.

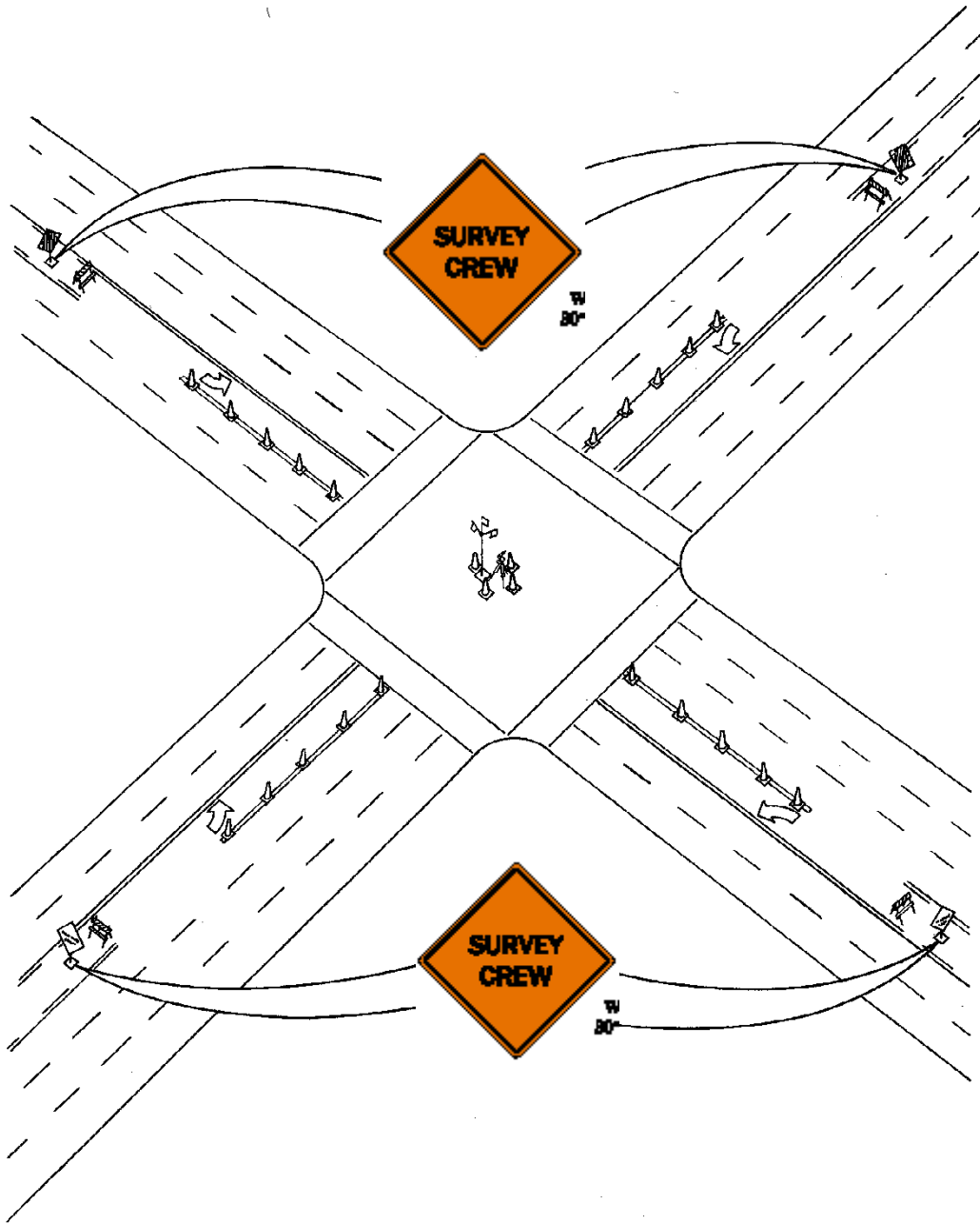
Surveyors working in the street must wear orange or fluorescent red-orange vests. Orange or fluorescent red-orange hats or caps should also be worn by surveyors when practical to help improve visibility for motorists.

Generally, the surveyor will be able to channel traffic easily with advance warning signs, high level warning devices and traffic cones. The surveyor's work in the street normally channels traffic to one side of a traffic lane rather than closing an entire lane. This channel may be made with cones or barricades using taper lengths and spacing as shown in Table 7.1.

"SURVEY CREW" advance-warning signs placed in advance of the work area are valuable to alert motorists of the surveyor's movements in traffic. The flag type, high level warning devices are valuable for survey work as it may be seen over the top of preceding vehicles. Use of high level warning devices is mandatory. A high level warning device must be used any time an instrument is set up in the street and should be used when a range pole is placed in a signalized intersection. Typical daytime traffic control illustrations are shown in Figures 7-J and 7-K.

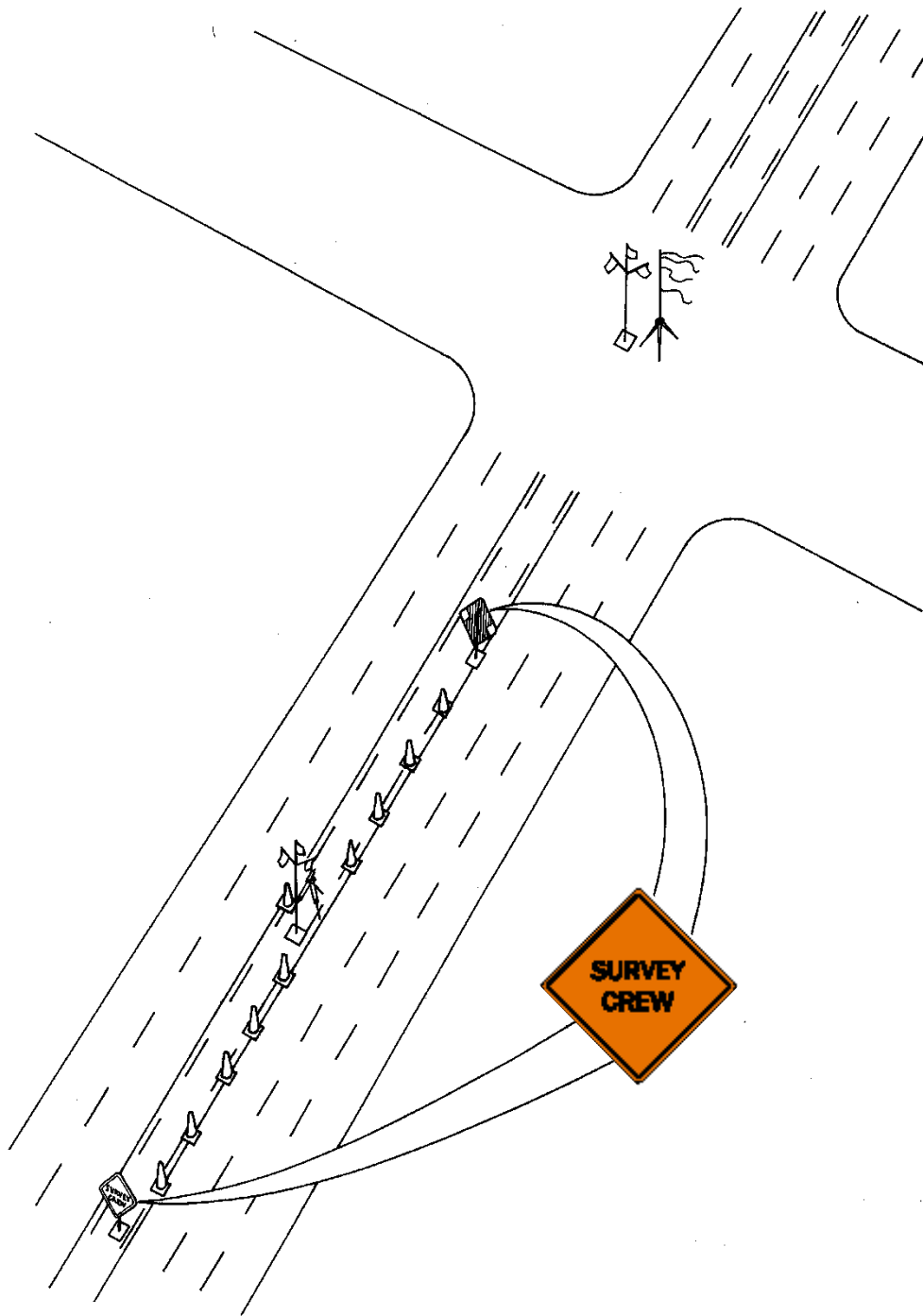
When surveying work requires restricting a full traffic lane or when restricting traffic during hours of darkness, traffic control devices (signs, barricades, channelization, etc.) must be provided as required elsewhere in this chapter for those conditions.

**Figure 7-J**  
**Surveying Intersection**





**Figure 7-K**  
**Surveying Midblock**



## 7.9 SERVICE VEHICLES

Vehicles covered in this section are only those vehicles that are required by the nature of their work to travel slowly or stop for brief periods in City streets. Vehicles used for minor maintenance of street lights, traffic signals, traffic signs, street painting, sweeping, gas leak detection, sanitation pickup, minor pavement patching, and the like.

Service vehicles can impose a safety problem for workers, motorists, and pedestrians. Service vehicle operations are prohibited on major and collector streets during peak traffic hours. During other times, the best and most desirable method for optimizing safety is for operators of service vehicles to plan their work to avoid stopping in the traveled portion of the street whenever possible, and when stopped, to reduce the time to a minimum.

When service vehicles must travel slowly or stop in City streets for brief periods, they must display one of the following operating, high level warning light systems (see Figure 7-L).

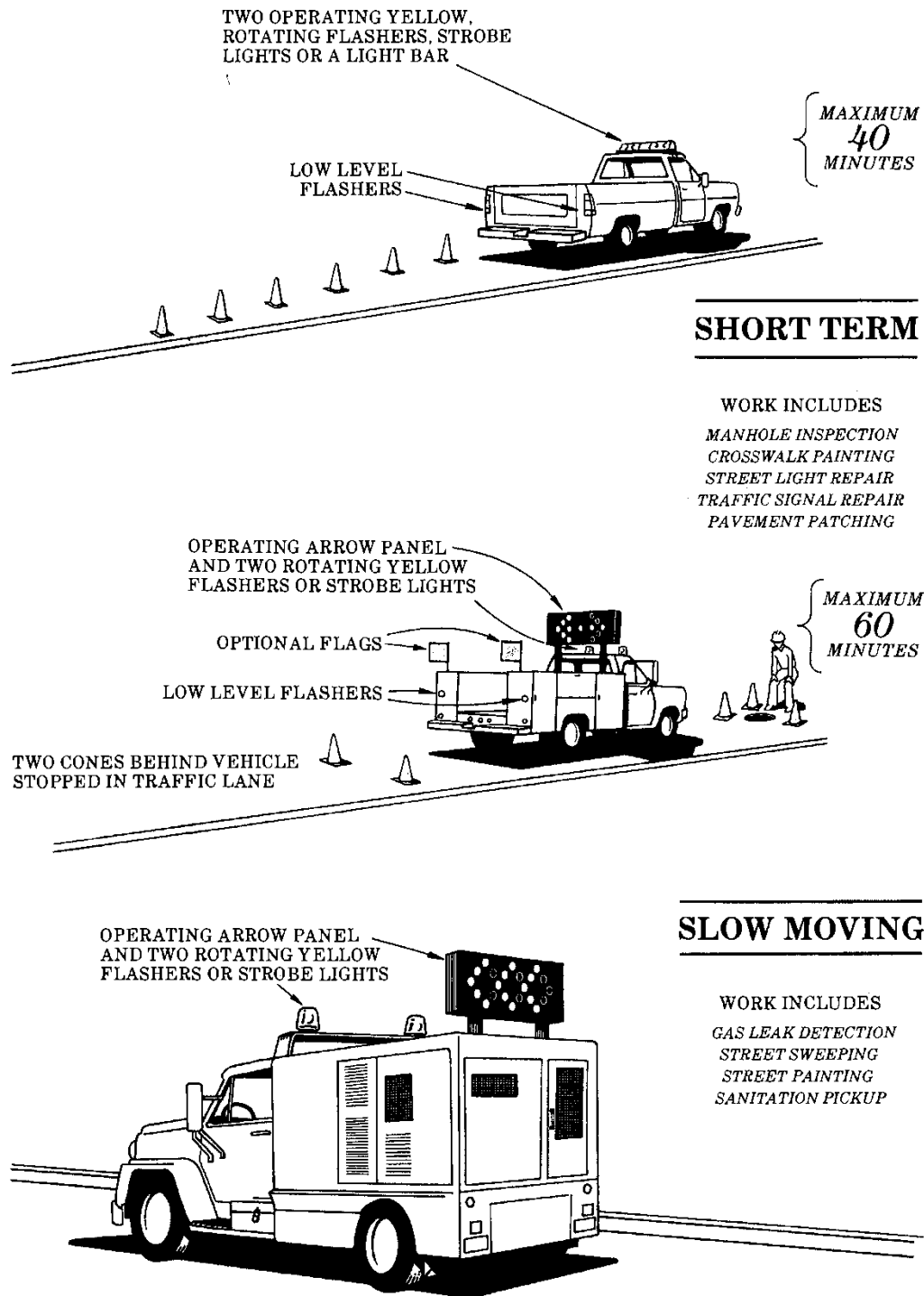
- a. Two Rotating Flasher or Strobe Light, High Level Warning Light Devices. These devices must provide 360-degree visibility. They may be used in combination and incorporated into a “light bar” for added visibility.
- b. One Advance Warning Arrow Panel. Arrow panels must be used in combination with rotating flashers or strobe lights to provide 360-degree visibility.

Flashing lights and arrow panels must be located on service vehicles so that they remain in full view, front and rear, at all times and are not obscured by dump beds, mounted equipment or work activities. Minimum mounting height must be 7 feet.

When service vehicles must stop in the street for brief periods, they must also display the vehicle’s four-way hazard warning flashers and at least two-traffic cones (each one 10 feet minimum to the rear of each rear corner). A short taper of cones (minimum 50 feet and 6 cones) at the rear of the vehicle may be used in high-density traffic areas to improve visibility. Flags on the upper rear corners of the vehicle may also be used to increase visibility.

(Intentionally left blank)

**Figure 7-L**  
**Service Vehicle Flasher Requirements**



Advance warning arrow panels provide additional advance warning and directional information when traffic must change lanes. Because they are more effective than flashing

lights, vehicles equipped with an arrow panel are permitted extended times when stopped in City streets for service work. Maximum stopped time per service location is:

- a. 30 minutes for vehicles equipped with two rotating flashing or strobe light high level warning devices.
- b. 60 minutes for vehicles equipped with advance warning arrow panels.

The more extensive signs, barricading and channelization, as required elsewhere in this chapter, are necessary for all service vehicles stopped in the street for more than 30 to 60 minutes, as applicable. Signs, barricades, and channelizing devices are to be used for moving operations in relatively fixed areas such as pavement crack sealing and tree trimming, when on arterial and collector streets. Usually, these devices are set up in short sections and moved as the work progresses.

### **7.10 BARRICADING ILLUSTRATIONS**

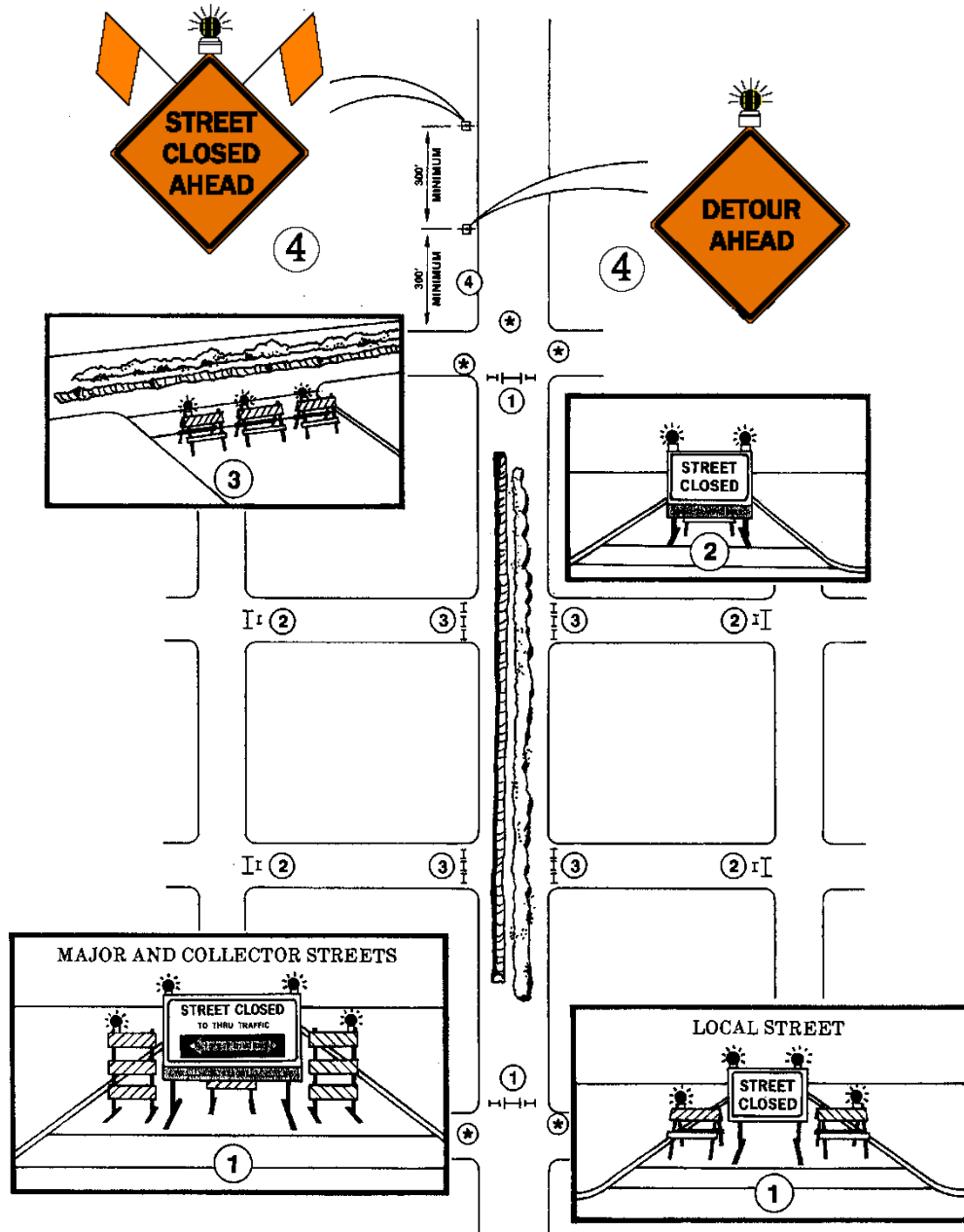
The traffic channelization and barricading illustrations on the following pages are presented to show typical applications of signs, barricades, and channelizing devices. They illustrate the methods required for uniform application of standard traffic control devices as set forth in this chapter. Specific situations not illustrated must be handled in conformance with the general methods and applications illustrated. The following illustrations are varied to show both daytime and 24 hour channelization as noted on the illustration where applicable.

Specific elements shown in the illustrations are:

- a. The “ROAD WORK AHEAD” sign is used approaching all construction areas in addition to all other required advance warning signs.
- b. Barricades or vertical panel channelizing devices are used to mark hazards (excavations, holes, equipment, construction materials, piles of dirt, sand, etc.), closed streets, and to protect workmen and pedestrians in the public right-of-way.
- c. Channelization may include use of traffic cones during daylight hours but cones must be replaced with barricades and/or vertical panel channelizing devices during hours of darkness.

Traffic control devices used during hours of darkness must be reflectorized and equipped with barricade warning lights as specified. Only Type C steady burn warning lights must be used on devices placed to form tapers, centerlines, lane lines, edge lines and other channelization to guide traffic. Type A or Type B flashing warning lights must be used on all signs and flag-type high level warning devices as specified. Type A flashing, warning lights should also be used on all devices placed to mark hazards because they are more effective for this purpose than the Type C steady burn lights.

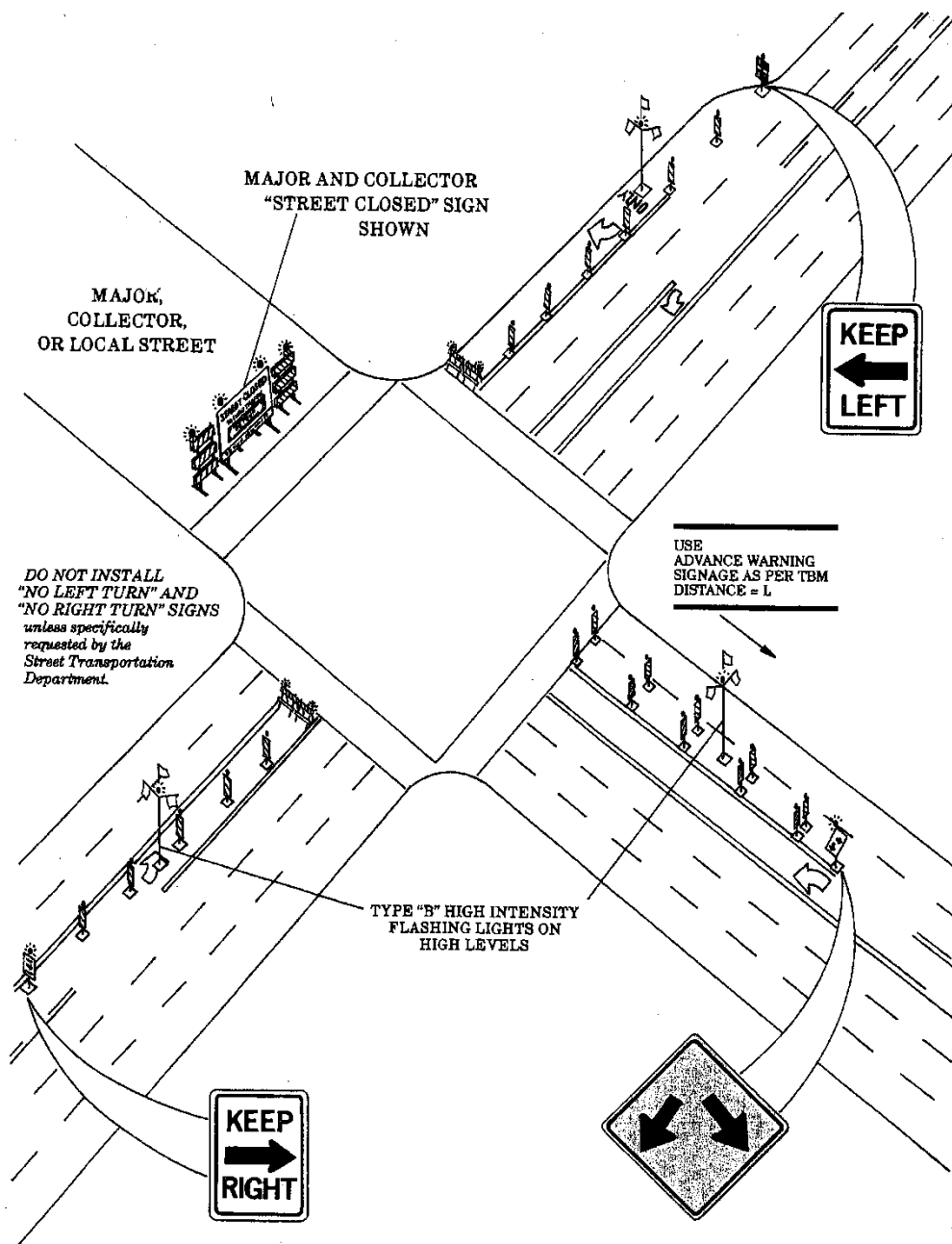
Figure 7-M  
Complete Street Closures



- ① STREET CLOSED. THE LARGE SIGN WITH THE DETOUR ARROW AND DETOUR DIRECTIONS SHALL BE USED FOR ALL MAJOR AND COLLECTOR STREET CLOSURES.
- ② STREET CLOSED SIGN, EXCEPT FOR LOCAL ACCESS, ON CENTER LINE OF STREET.
- ③ STREET BARRICADED AT CONSTRUCTION AREA.
- ④ ADVANCE WARNING SIGNS SHALL BE USED ON MAJOR AND COLLECTOR STREETS.
- \* EXISTING MANDATORY TURN LANES APPROACHING CLOSURES SHALL BE CLOSED (SEE FIG. 16)

☀ Flashing Lights

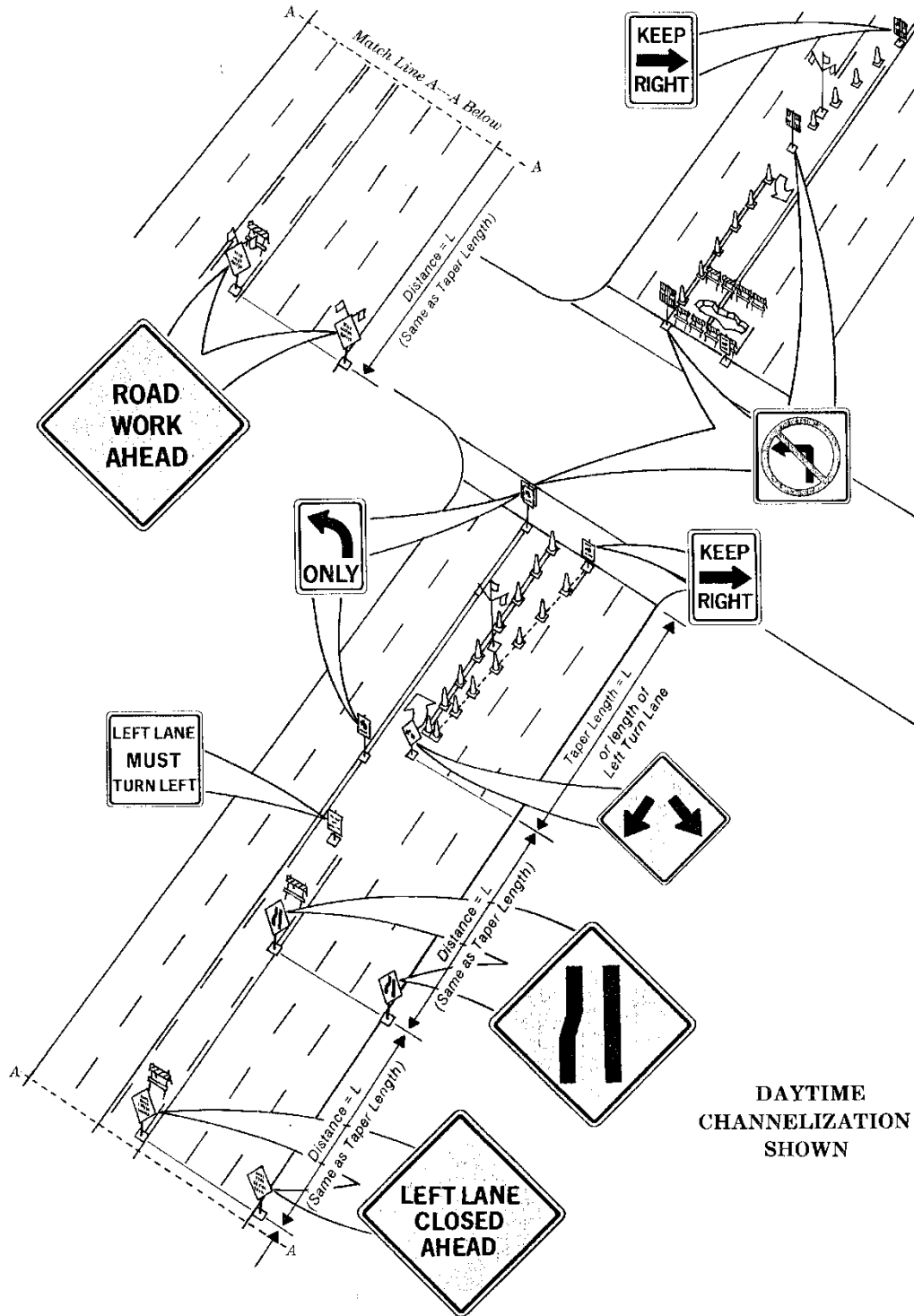
**Figure 7-N**  
**Mandatory Turn Lane Closures**



**24 HOUR CHANNELIZATION SHOWN**

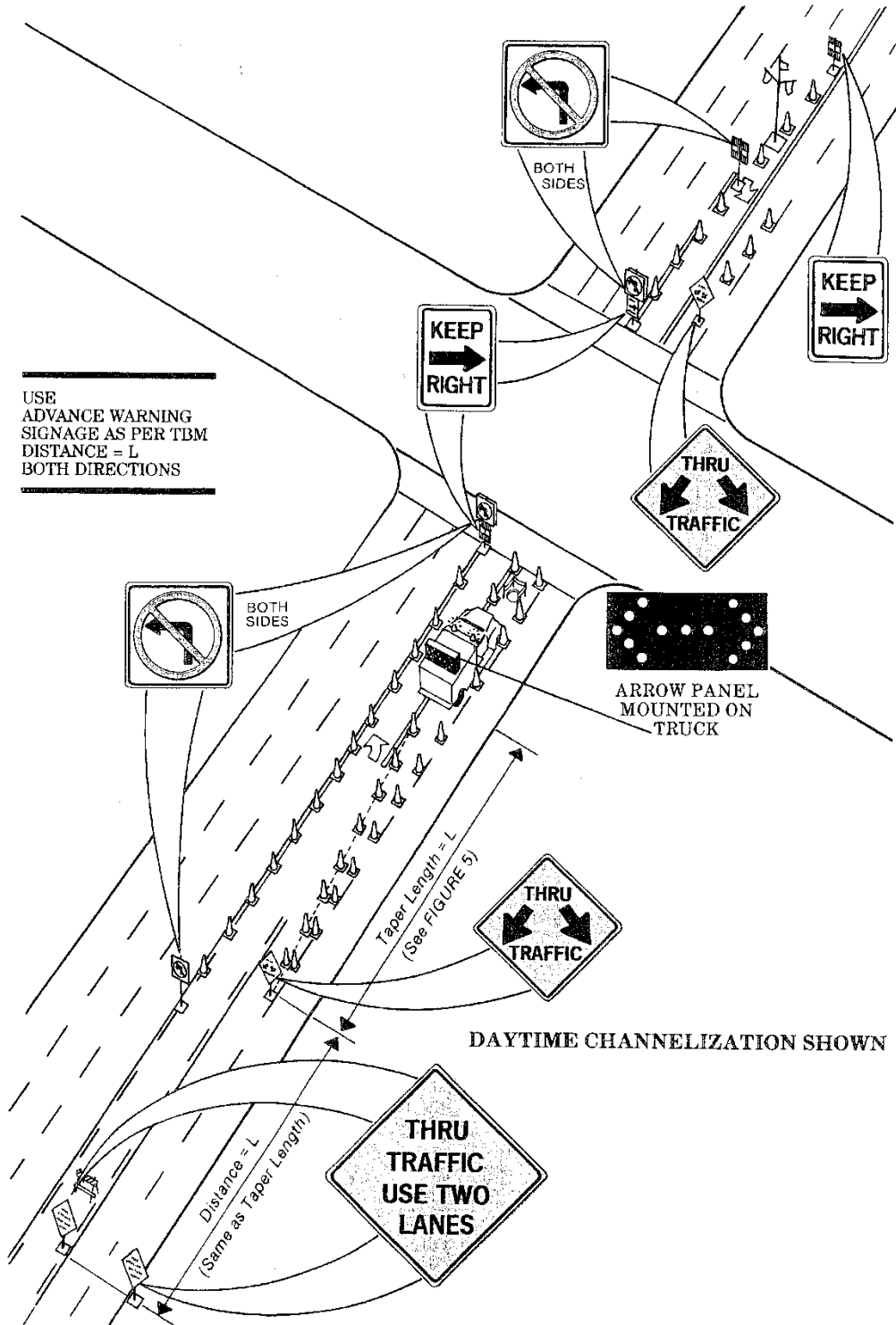
- Steady Burn Lights
- \* Flashing Lights

**Figure 7-0**  
**Left Lane Closed**  
**Intersection Left Turn Lane Open**

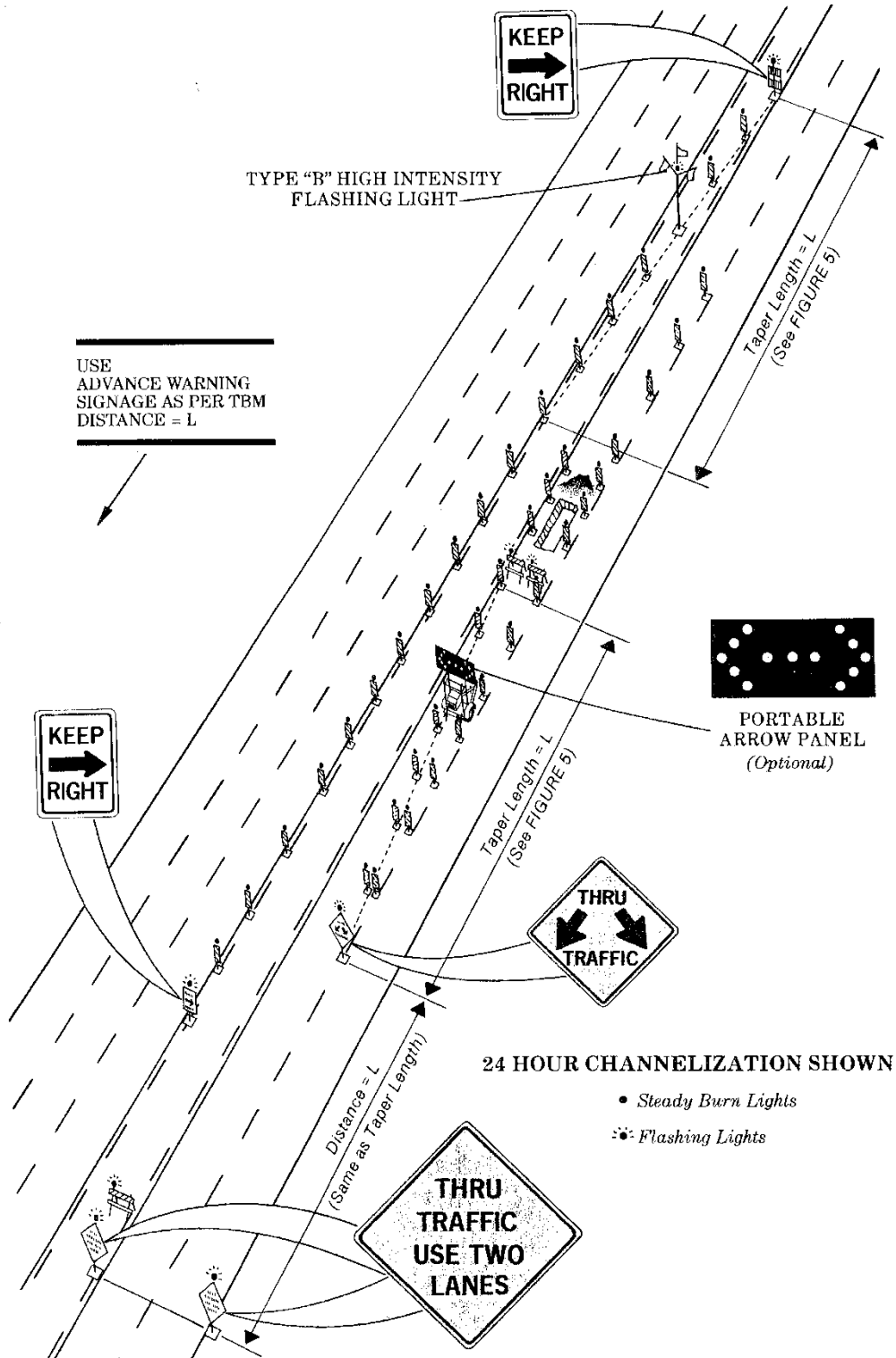




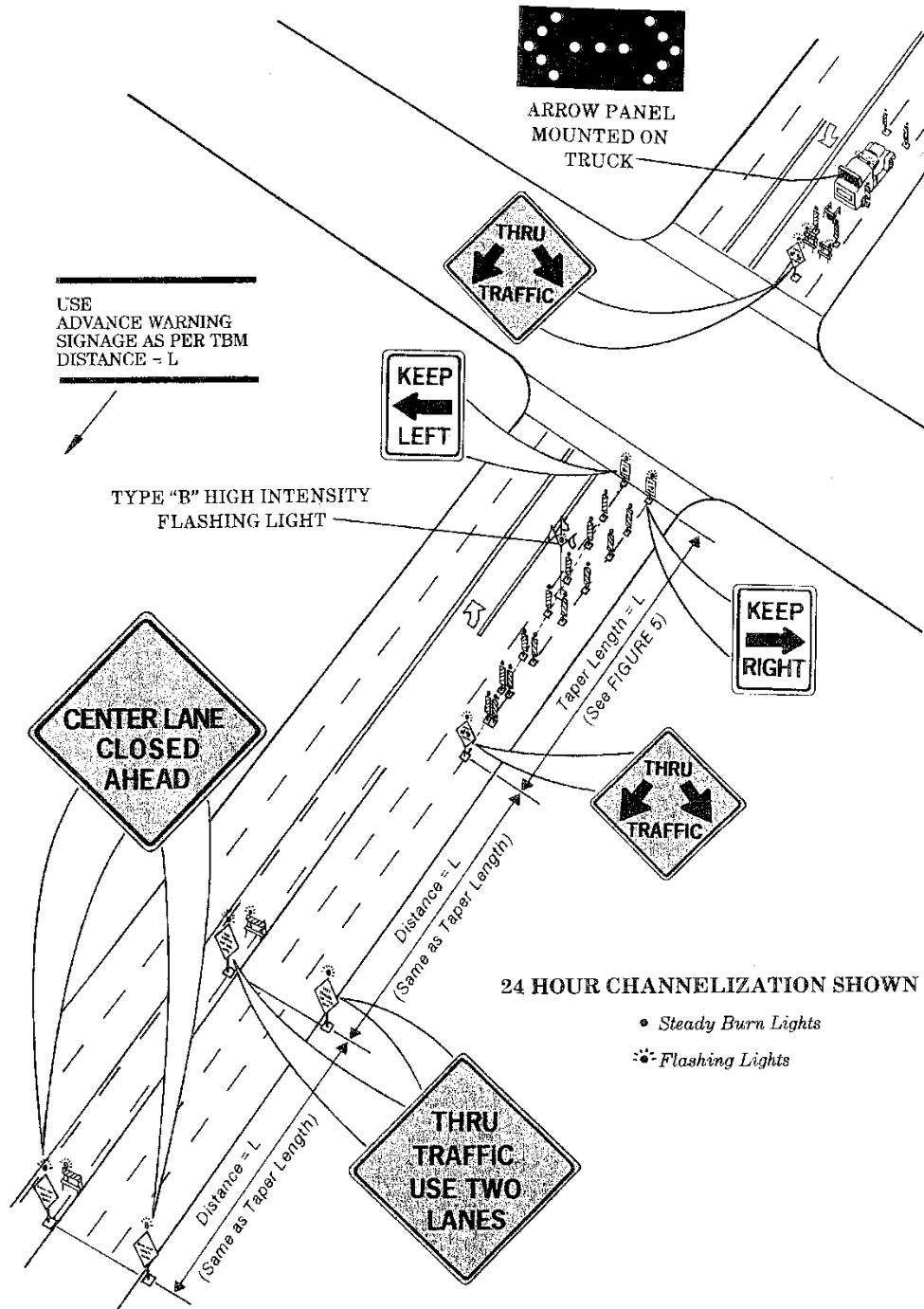
**Figure 7-P**  
**Left Lane Closed**  
**Intersection – Two Lanes Open**  
**Using Left Turn Lane**



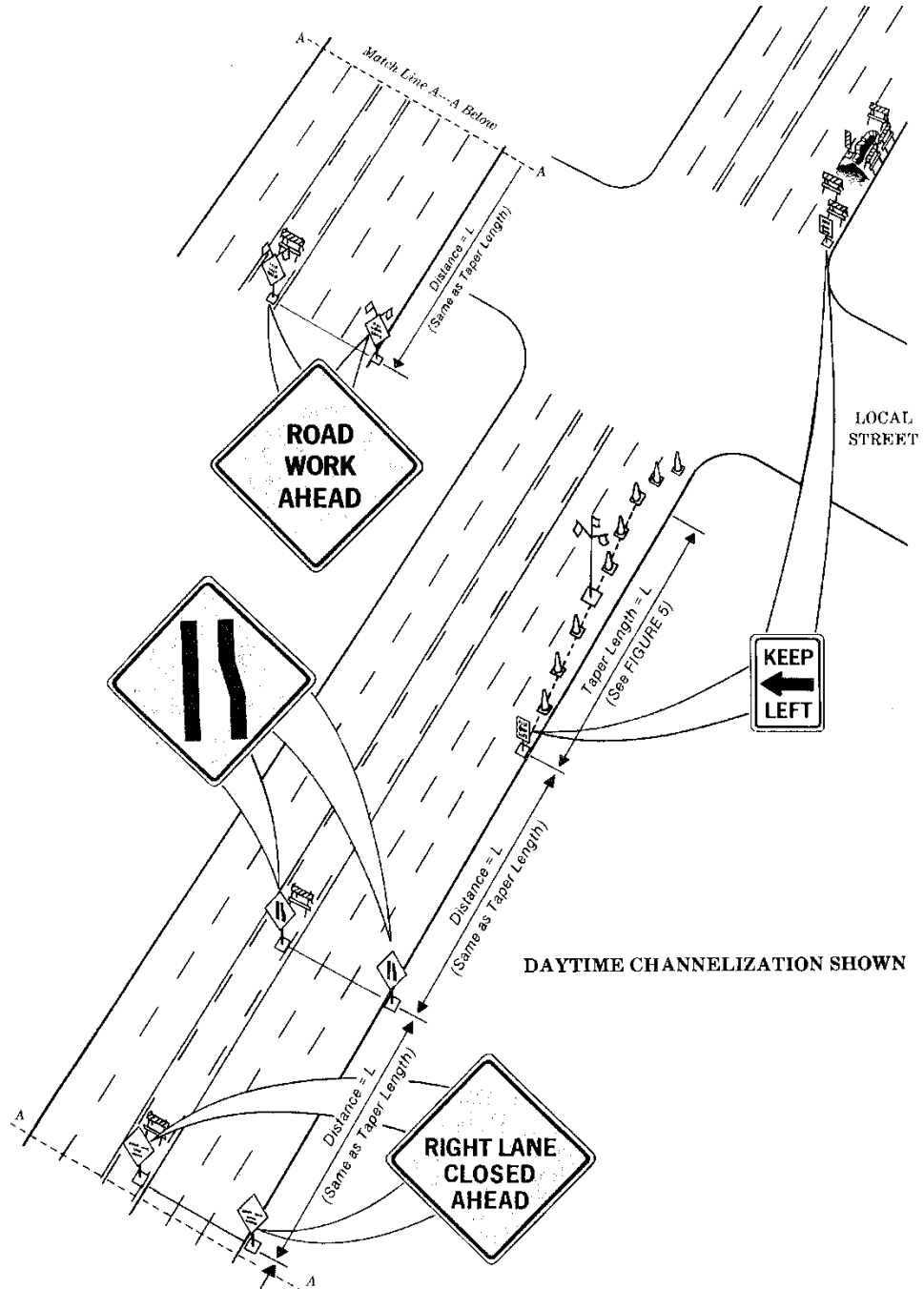
**Figure 7-Q**  
**Left Lane Closed**  
**Midblock – Two Lanes Open**  
**Using Left Turn Lane**



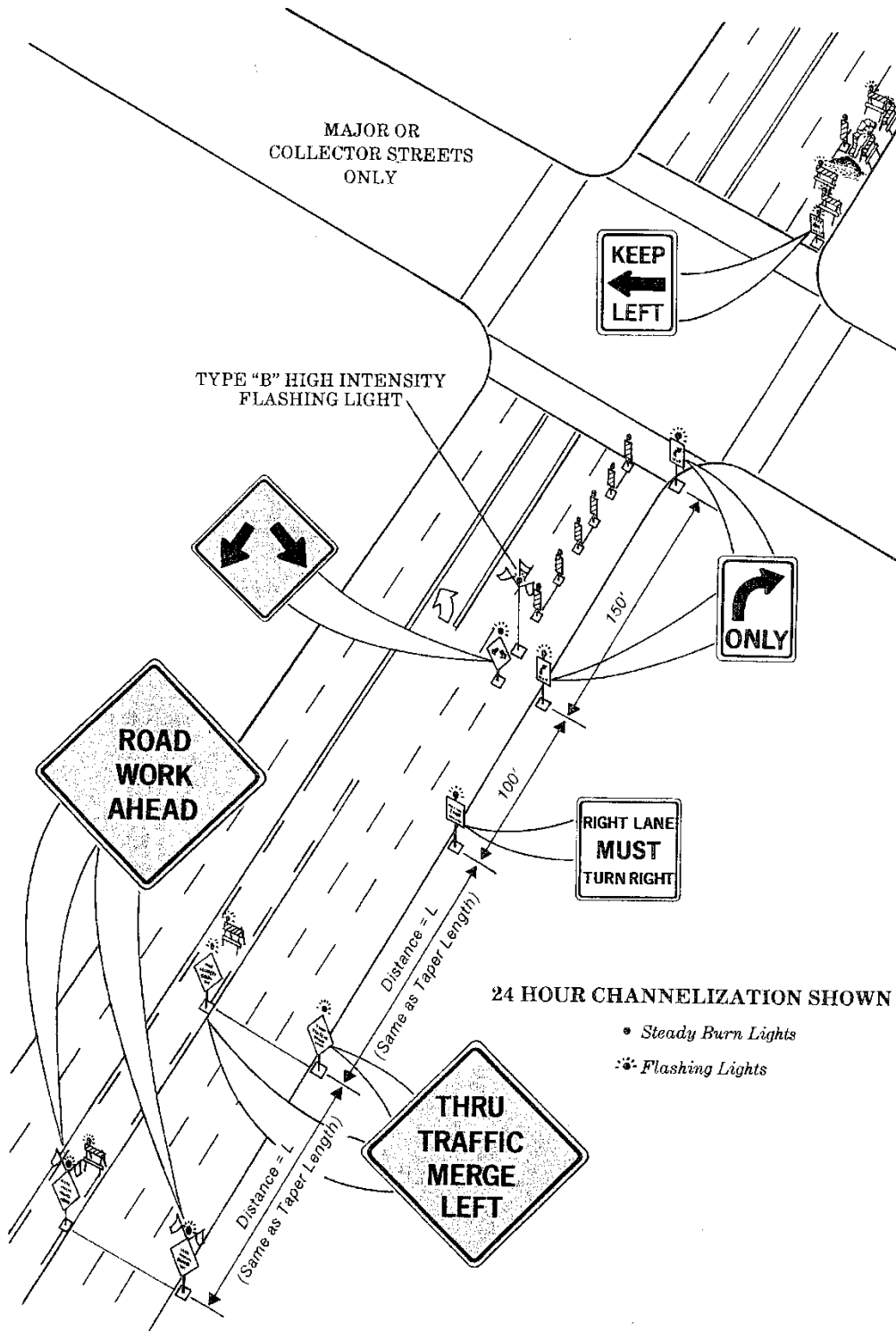
**Figure 7-R**  
**Center Lane Closed**  
**Intersection – Two Lanes Open**



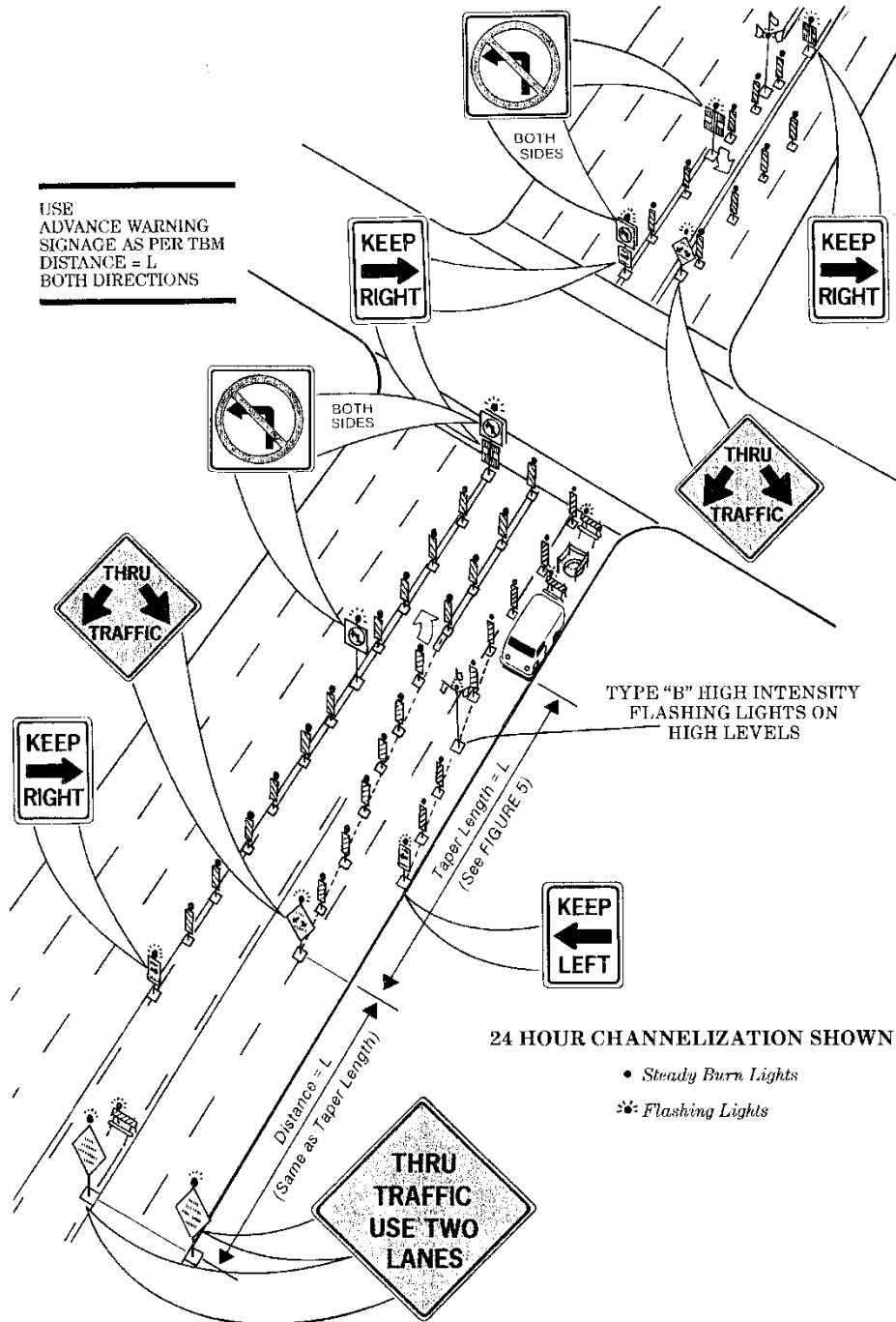
**Figure 7-5**  
**Right Lane Closed**  
**Intersection – Two Lanes Open**



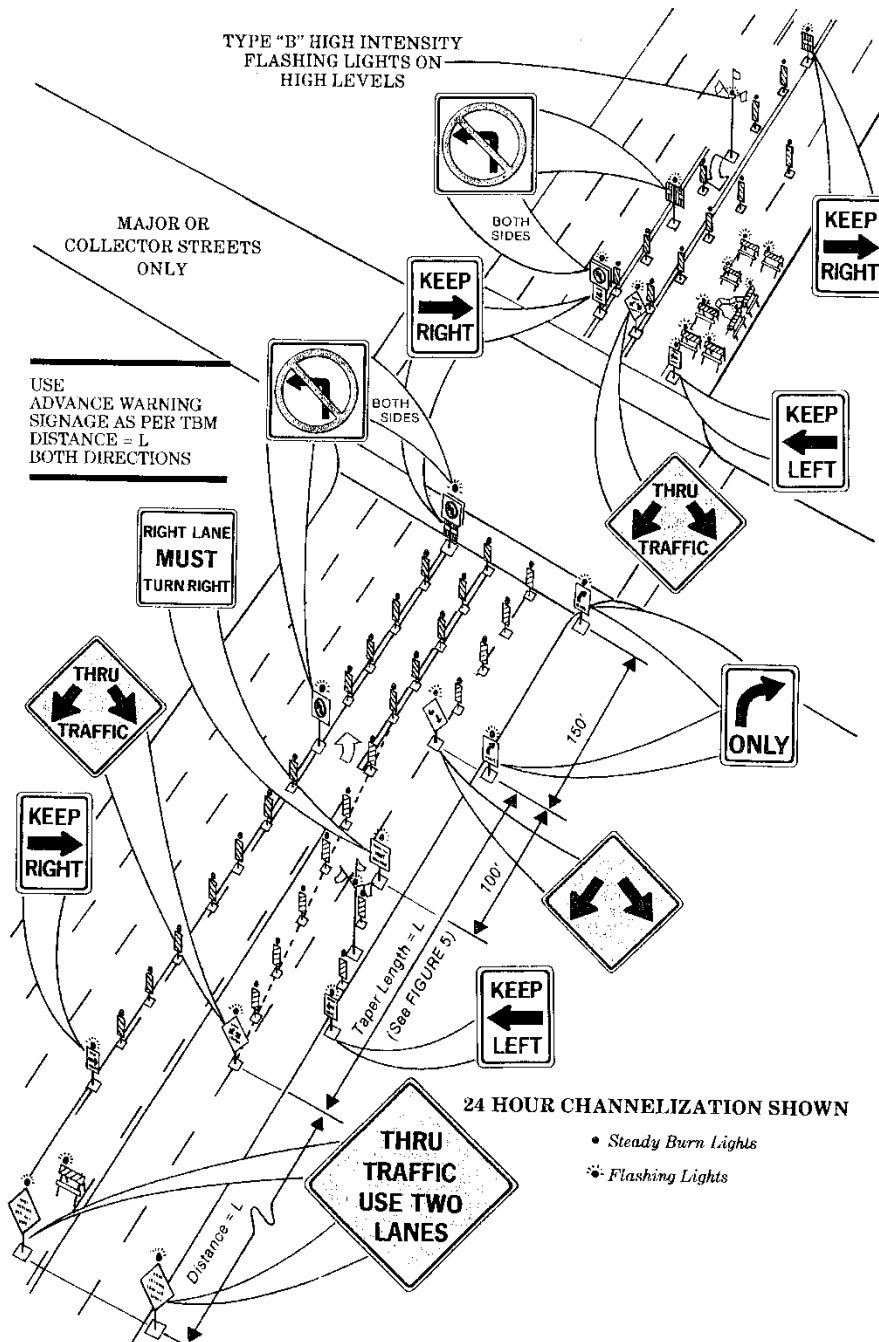
**Figure 7-T**  
**Right Lane Closed**  
**Intersection – Right Turn Lane Open**



**Figure 7-U**  
**Right Lane Closed**  
**Intersection – Two Lanes Open**  
**Using Left Turn Lane**

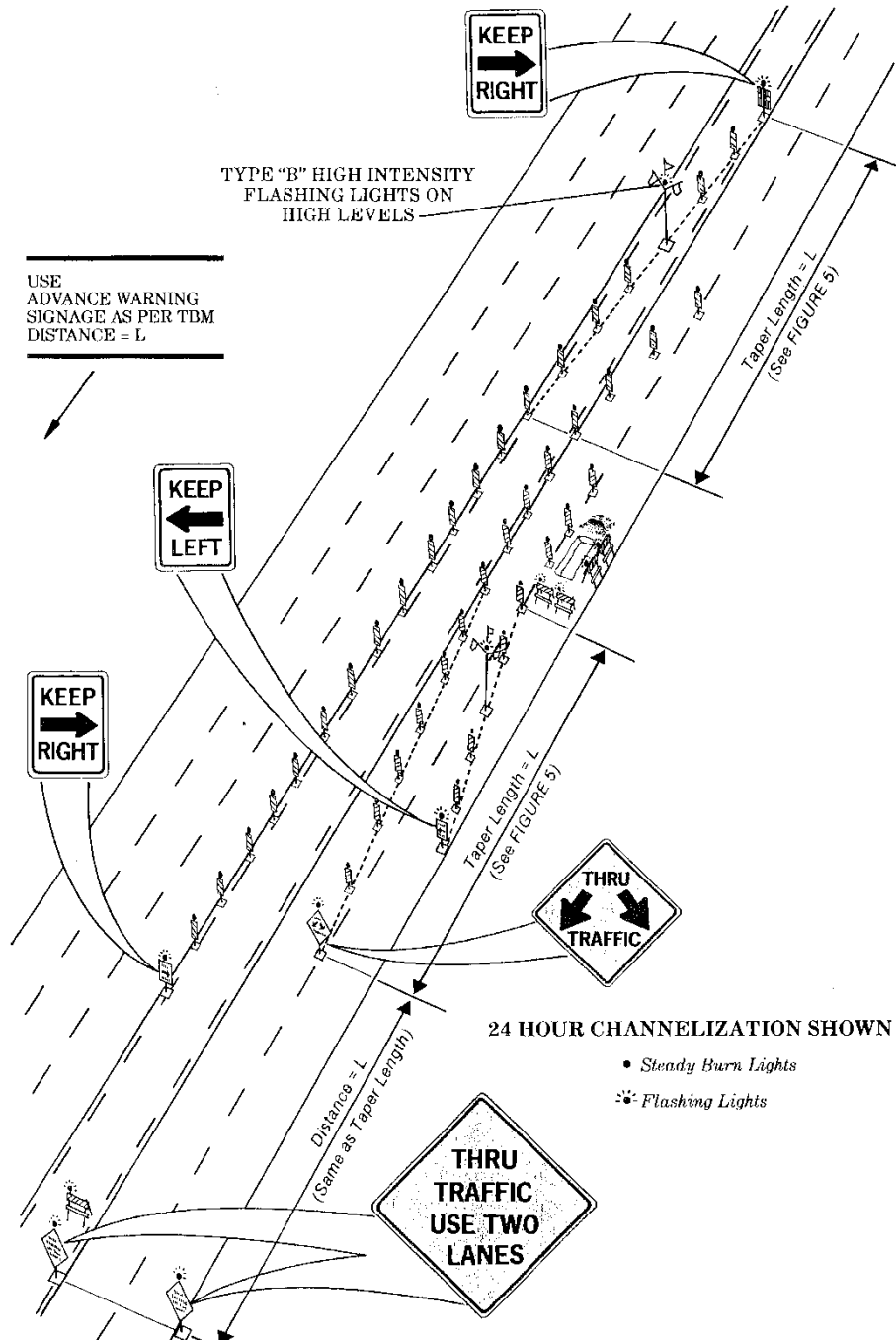


**Figure 7-V**  
**Right Lane Closed**  
**Intersection – Two Lanes Open**  
**Using Left Turn Lane – Right Turn Lane Open**

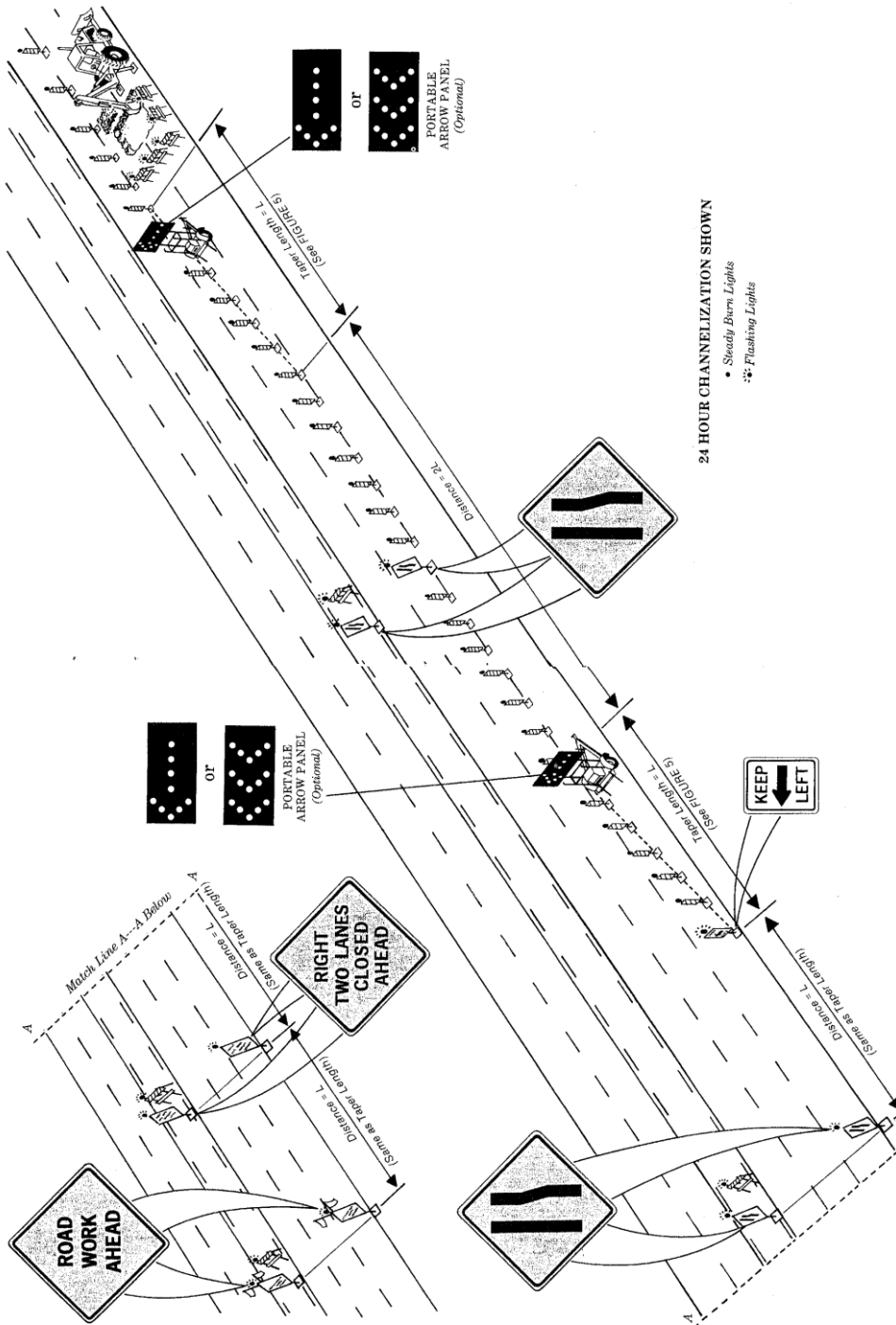




**Figure 7-W**  
**Right Lane Closed**  
**Midblock – Two Lanes Open**  
**Using Left Turn Lane**



**Figure 7-X**  
**Two Right Lanes Closed**  
**Midblock**





**Figure 7-Z**  
**Half Street Closed**  
**Traffic Across Centerline**

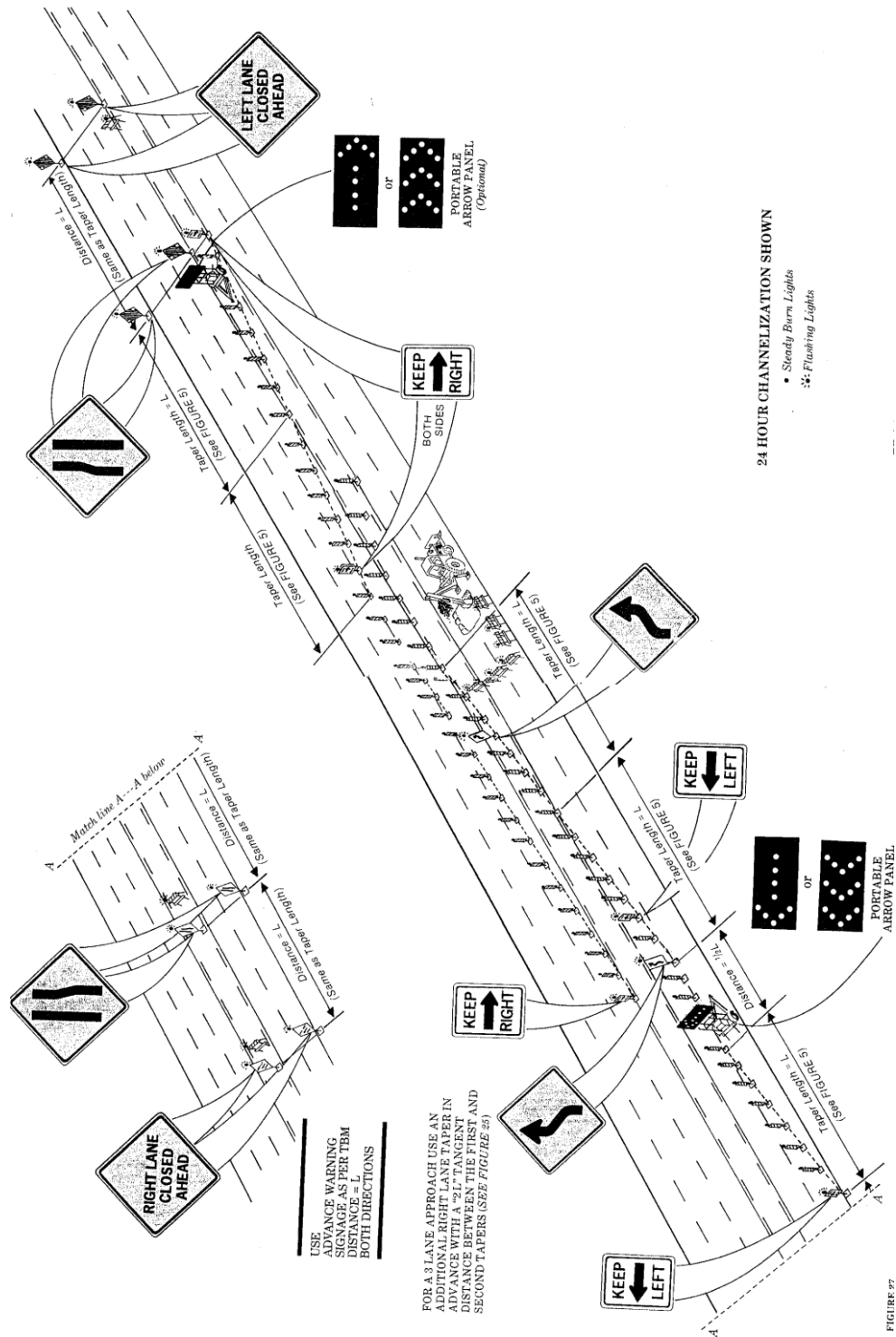
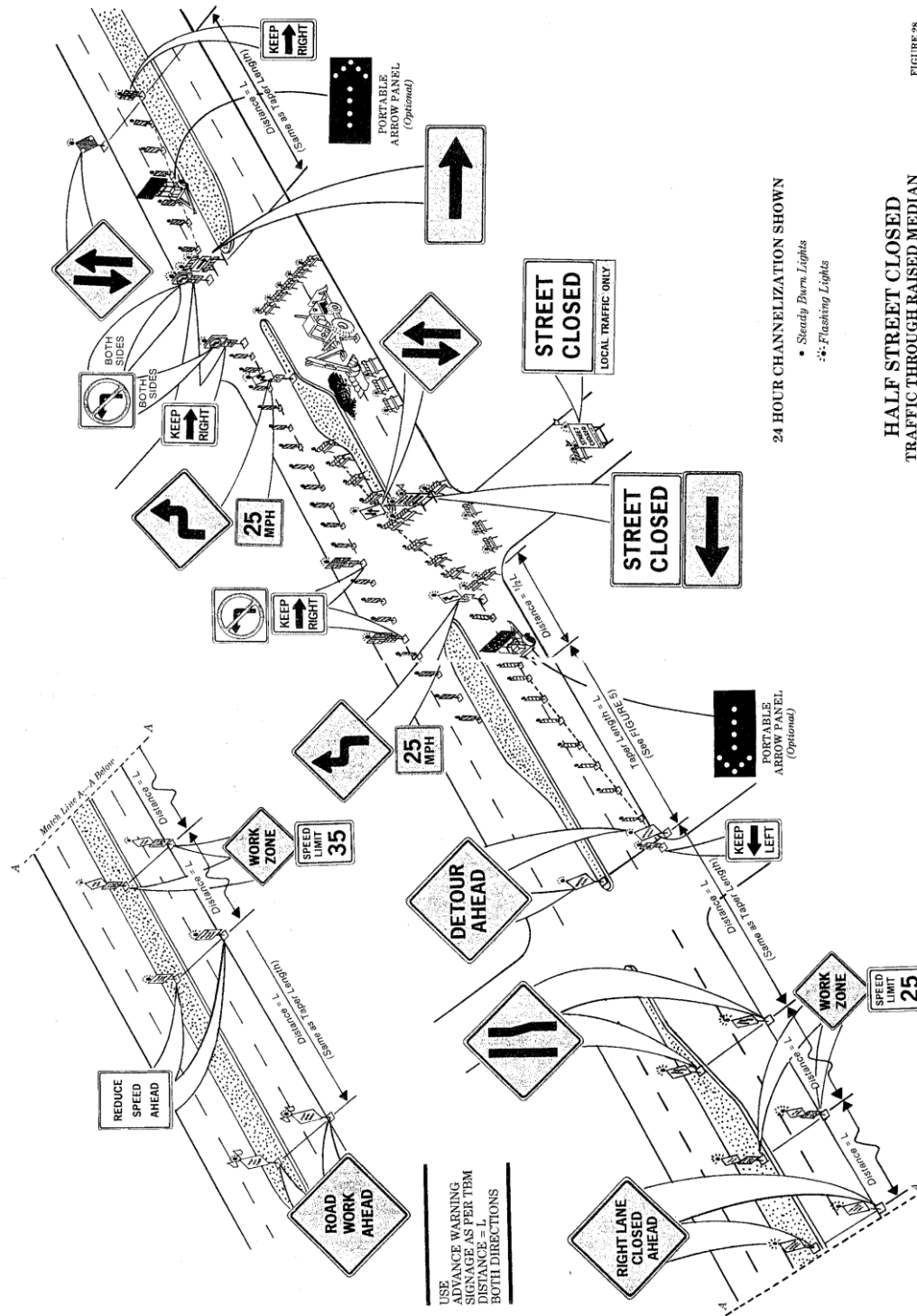
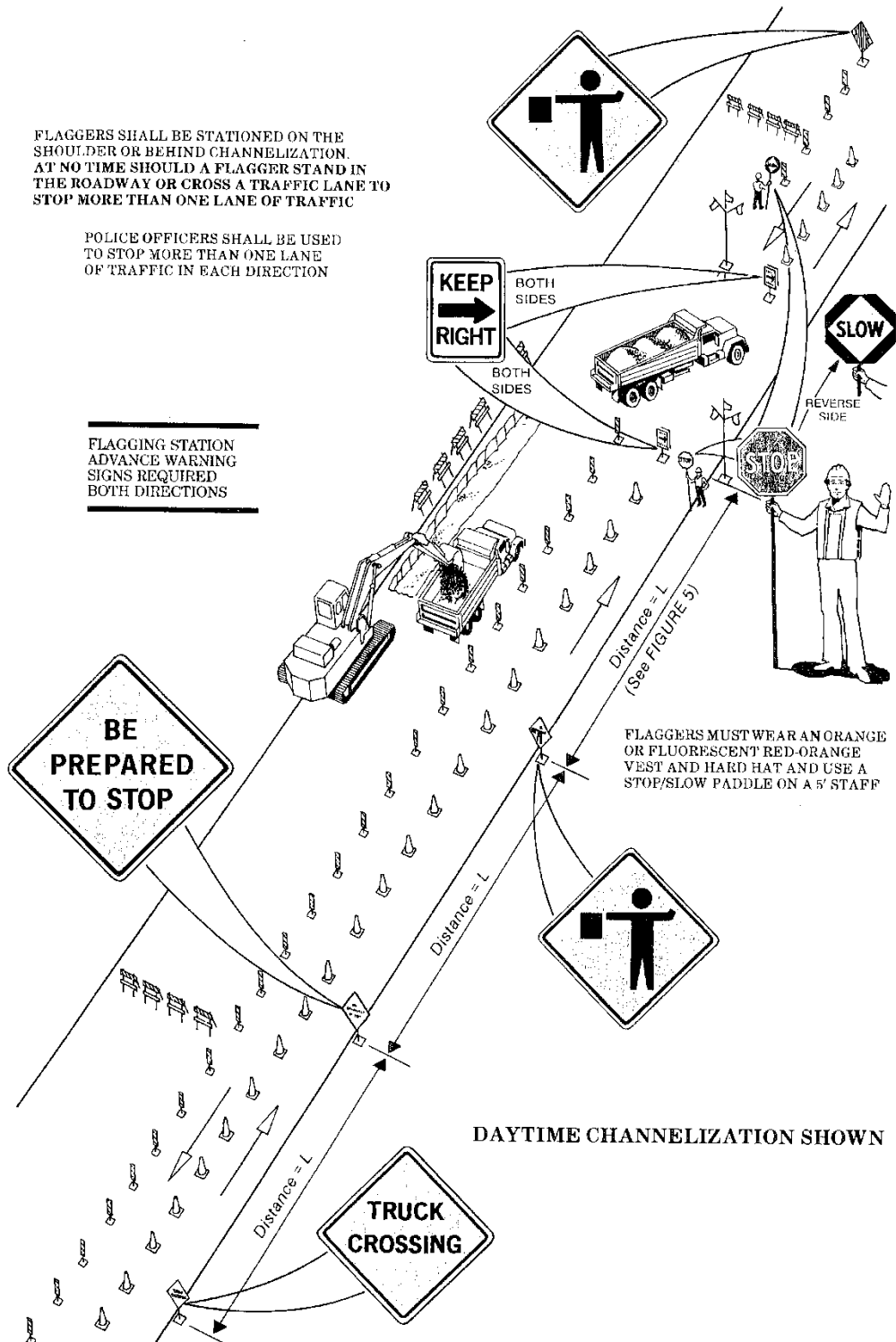


FIGURE 7-Z

**Figure 7-AA**  
**Half Street Closed**  
**Traffic Through Raised Median**

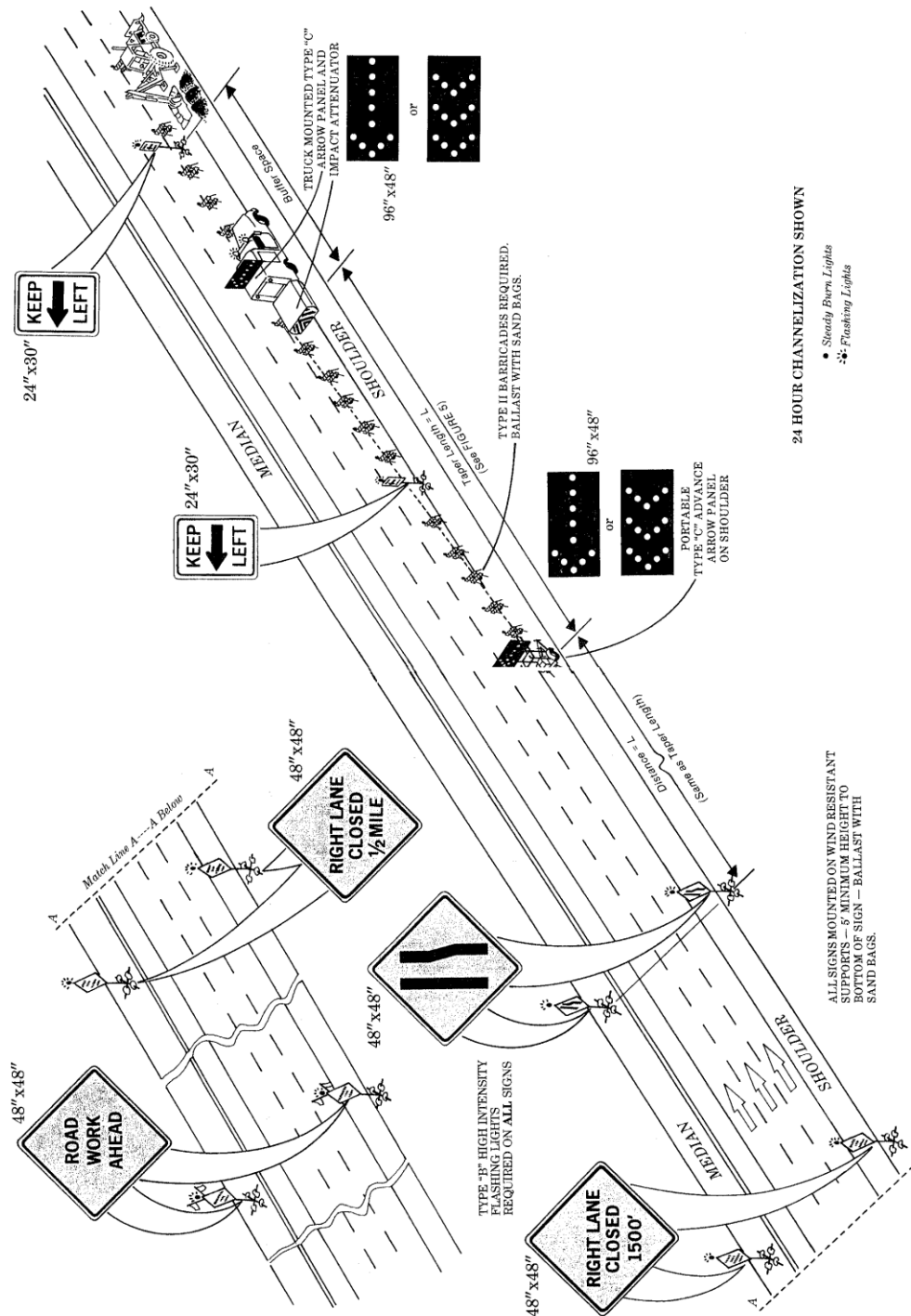


**Figure 7-BB  
Flagging Station  
in Construction Area**





**Figure 7-CC**  
**Freeway and Expressway**  
**Right Lane Closure**



## **Chapter 8 - Landscape Design of City Owned R.O.W., Medians, and Retention Basins**

### **8.1 GENERAL INFORMATION**

Establish a standardized set of minimum requirements in accordance with the City of Chandler Zoning Code (35-1093 Landscaping), City Supplements, and MAG Specifications and Details, for the use as guidelines for landscaping City-owned landscape, predominately retention basins, rights-of-way, and medians.

Developers will be required to adhere to these guidelines with staff review and inspections as specified.

All development and installation must be completed and accepted by the City.

All improvements must be in accordance with the current Federal regulations and requirements of the Americans with Disabilities Act. Coordinate all design to prevent conflicts or restrictions on routes and facilities providing access for the people with disabilities.

Consideration must be given for utilization of reclaimed water. Reclaimed water may be available for projects south of Pecos Road.

The City encourages sustainable practices. Although subject to the approval of the Streets Superintendent, proactive proposals utilizing current advances are desirable. The City would rather not dictate solutions but would like to see them proposed utilizing state of the art, current, innovative strategies.

#### **8.1.1 Purpose**

These landscape standards have been assembled to establish minimum guidelines for the design and development of landscaped boulevard strips (the area between the back of the outside curb and the rights-of-way), medians, and retention basins within City of Chandler. These standards are not intended to provide design solutions or treatments for all landscape areas or address site specific conditions. The primary purpose for these guidelines is two-fold. First, they are provided to establish a framework of design criteria and parameters to ensure a comprehensive and unified approach to landscape enhancement. Their secondary purpose is to provide the design consultant with a recommended guideline and reference for standardization of materials, equipment selection and installation requirements that are in accordance with the standard of quality required by the Public Works & Utilities Department, Streets Division.

These landscape guidelines are not intended to specify any pedestrian or traffic safety requirements. The Design Professional must rely on other current design manuals or documents for the proper guidance for all safety issues related to their design. The safety



recommendations in other design manuals or documents will take precedence over these landscape guidelines.

Designs must consider the ability of landscape maintenance crews to access the landscape maintenance area in that the crews should not be endangered by extensive thorns or spikes on the plant material which may be preventative of staff to walk about the landscaped area safely.

Work covered by the above must include, but not be limited to:

- a. Site Preparation
- b. Excavation
- c. Grading and Drainage
- d. Plant, Turf and other material Installation
- e. Water Supply and Irrigation
- f. Tree Planting and Staking
- g. Accessibility – Americans with Disabilities Act

### **8.1.2 Submittal Procedures, Review, and Scheduling**

#### **8.1.2.1 Pre-Submittal Conference**

The Developer must also meet with the City's user department/division (User Department) that will be assuming the operation and maintenance to ascertain priorities, discuss intended improvements, and review City Standards and site development requirements.

#### **8.1.2.2 Conceptual Landscape Plan**

Conceptual Landscape Plan may also be required to be submitted for review by the User Department as part of the approval process.

#### **8.1.2.3 Final Landscape Plan**

A Final Landscape Plan, Irrigation Plan, cost estimate, and development schedule must be submitted and approved by the City prior to the start of any on site improvements.

#### **8.1.2.4 Traffic Control/Barricade Plan**

The Contractor is to obtain an approved and current traffic control or barricade plan as may be required. All approvals are to be coordinated through the City's Traffic Engineering Division.

#### **8.1.2.5 Start Construction**

The Contractor must notify the User Department, in writing, two weeks prior to the start of work indicating the date on which work is to commence.

#### **8.1.2.6 Utilities**

The Contractor must coordinate with existing utilities. This includes, but is not limited to the electric utility to service pumps, controllers, and lighting, as may be required. Blue Staking will be required at a minimum.

#### **8.1.2.7 Plant Material**

The material will be “tagged” and available for inspection and approval before planting. “On-site” inspection will be conducted upon delivery. Notification of delivery will be the responsibility of the Contractor; substandard material will be rejected at that time. At the option of the City Streets Superintendent, nursery inspection and/or plant selection may be requested.

#### **8.1.2.8 Inspection**

The Contractor must notify the User Department at each pertinent stage of construction to allow for periodic inspection. Any workmanship or materials not meeting City standards will necessitate a correction of the deficiency before additional work may be done.

#### **8.1.2.9 Preliminary Acceptance**

The Contractor must make a written request to the User Department for preliminary acceptance of the improvements. Approval of this request will begin the ninety-day maintenance period.

#### **8.1.2.10 Final Acceptance**

The Contractor, upon completion of the ninety-day maintenance period, must forward a written request for final acceptance of the improvements to the User Department. The maintenance period will be extended, if necessary, until such time as the improvements are acceptable. The Contractor must forward a mylar print, digital file, two irrigation manuals, one operation and maintenance manual, and transfer the utilities to the proper User Department to finalize acceptance of the improvements.

#### **8.1.2.11 Preliminary and Final Acceptance**

Will only apply when the City is to assume maintenance. In all other cases, the developer will simply request final approval.

### **8.1.3 Landscape Plan Requirements**

- a. All plans must include most current Landscape Notes found on City Unified Development Manual website.
- b. Provide separate offsite landscape, irrigation and hardscape plans. Minimum scale is 1"=30' and to be submitted on 24" X 36" plan sheets. Include a Vicinity Map and sheet index on the Cover Sheet. Digital plan submittal may also be required.
- c. All medians must be shown on Civil Plans.
- d. Show the location of existing and proposed plant materials on Landscape Plan.
- e. Include plant schedule specifying graphic symbol, botanical and common names, planting size, number of plants and on-center spacing within the Landscape Plan set. All trees must comply with the latest edition of the Arizona Nursery Association *Container Grown Tree Guide*.
- f. Include location of overhead and underground utilities, streetlights, signage, valve boxes, etc. Contact the appropriate utility for acceptable plant material species and location.

#### **8.1.4 As-Built Drawings**

The Developer or Contractor will be responsible for providing one mylar print and an approved format electronic file of the system with all changes in location marked. This must be given to the City prior to final acceptance. No final payment will be made until the as-built drawings have been received by the City.

### **8.2 GENERAL LANDSCAPE STANDARDS**

#### **8.2.1 General Design Considerations**

Landscaping of public right-of-way and retention areas is important to the overall image, character and visual quality of the primary circulation corridors throughout the City of Chandler. The landscape design should attempt to provide year round aesthetic appeal and interest; improve space and scale relationship of the roadway for the users; accent or improve awareness of community features; provide visual screening; micro-climate enhancement; provide a model for conservation and sensitivity to our natural environment, and water consumption; and minimizing maintenance requirements.

Minimizing and ease of maintenance must be a primary consideration in the selection, location, and installation of all landscape plant material, irrigation materials, and equipment.

Plant material selection and layout must consider the mature growth potential and natural growth habit of each plant species.

Careful consideration must be given to the selection and placement of all plant materials with regards to frost/heat sensitivity, solar or shade exposure, and susceptibility to pests and diseases.

It is strongly recommended that the Design Professional utilize a multiple plant species palette and multiple plant massing combinations to increase visual diversity, enhance seasonal interest and avoid potential large scale plant losses. Design Professionals should avoid over-use of a particular plant species due to the potential for single species die-out or maintenance problems resulting from horticultural conditions, climate hardiness or diseases impacting a monoculture plant type.

#### **8.2.2 Materials - General**

Once the City has approved the plans, no substitutions will be allowed, except when unavailable from the supplier and another approved product is locally available. The User Department must approve all such substitutions in writing. All materials must be new and the best of their class and kind. All materials and workmanship must be guaranteed for a period of one year from the time of User Department acceptance against material defects and workmanship.

Landscape materials for use within the public right-of-way must consist of the following:

### **8.2.2.1 Plants**

Plant materials must consist of ground cover plants, succulents, cacti, shrubs, and trees. All plant material must be selected from the Arizona Department of Water Resources (ADWR) approved list of low water use plants for use within the public right-of-way. Although allowed by the ADWR approved list, not all plant materials are appropriate for use within the public right-of-way. Palm trees and yellow and purple lantana is prohibited unless approved by a City Representative.

### **8.2.2.2 Inert Ground Covers**

Inert ground covers are defined as rock ground covers and decorative pavements. Rock ground covers include decomposed or crushed granite, gravel, stone, and boulders. Boulders, stone or rock aggregate may be used within median landscape areas but the exposed surface height may not exceed 8 inches in height or placed within 6' to the face of curb. Faux boulders are acceptable – typically LR series random sizes by Poolrock.com or approved equal. Decorative pavements may include interlocking paving units for raised medians or patterned/textured concrete. Decorative pavements may have defined applications within right-of-way streetscape or may be used to accent or enhance streetscape features. All proposed paving treatments will be subject to the City's approval. Selected areas of raised medians require interlocking paving units – typically Acker Stone 60% Street Stone I, 6cm, Old Town Blend, 40% Street Stone II . 6 cm, Old Town Blend or approved equal is utilized. In some situations, the pavers may be required to be set in concrete.

### **8.2.2.3 Turn Grasses/Lawn**

In accordance with the Arizona Department of Water Resources (ADWR), proposed turf area introductions are not allowed within the public right-of-way, unless such areas are designed to utilize reclaimed water or unless the area is associated with preexisting turf areas.

## **8.2.3 Plant Materials**

Unless otherwise indicated, all plant materials furnished must be nursery-grown, well branched, and well proportioned. All plants are subject to inspection and approval before planting, whereupon all plants found unsuitable must be removed and replaced.

Substitutions: Plants of kinds other than those indicated on the plant list may be considered by the User Department only upon submission of proof that any specified plant is not reasonably procurable in the local region. Substitution will require prior approval by the User Department based on the characteristics of the kind of plant specified in regards to appearance, ultimate height, shape, habit of growth, general soil, and other requirements. In no case, may the average cost and value of the submitted plants be less than the cost and value of plants indicated.

Protection after Delivery: Upon delivery to the site, all nursery stock must be planted as soon as possible. Until planting, stock plants must not be exposed to excessive sun or drying winds during planting operations.

Reference and standards for all plant material must be as per the “Arizona Nursery Association Standards for Nursery Stock”, most current edition.

### **8.2.3.1 Quality and Size**

All trees must have sufficient roots to hold the earth together after removal from the containers but must not be root-bound. Plants must have been grown in pots, cans, containers, or boxes for a minimum of three months and a maximum of one year.

All plants must have a normal habit of growth and must be sound, healthy, vigorous, and free from disease, insect infestations or weeds.

Trees must have a straight trunk throughout their height and must be in accordance with the Arizona Standard for Nursery Stock, most current addition. Multi-Trunk trees are not permitted in a median without authorization from a City Representative.

### **8.2.3.2 Materials for Planting**

- a. Manure (for mulch): Must be well-rotted, unbleached stable or cattle manure, reasonably free from shavings, sawdust or refuse and must contain no more than 10 percent straw by volume.
- b. Humus (for prepared soil): Must be sterile peat or peat-moss or decomposed stabilized and fortified, treated (nitrolized) wood mulch, with no more than 1 percent nitrogen after treatment and must be fir mulch, pine mulch, or redwood mulch type.
- c. Prepared Soil (for backfilling tree pits): Mix 3 cups soil sulfur per 15 gallon tree, 5 cups per 24-inch box tree. Mix sulfur with planting mix; which must be 1 part imported topsoil to 1 part mulch and 1 part sand. Topsoil must be natural, fertile, friable soil which must not be excessively acid or alkaline nor contain toxic substances harmful to plant growth and be reasonably free of noxious weeds, clay clumps, clods, stones, roots, stumps, and debris of any kind. All imported topsoil must have soil analyses before it can be incorporated on the project.
- d. Staking Materials:
  - i. Stakes for supporting trees must be placed outside of tree pit per City Detail C-801.
  - ii. Tie wire for fastening trunks to stakes must be per City Detail C-801.
  - iii. Rubber Hose to protect trunk from wire must be per City Detail C-801.
  - iv. Install Arbor Guards to all planted trees in turf.

### **8.2.3.3 Setting Plants**

Unless otherwise specified, all plants must be planted in pits and must be set so that the finish grade will be the same as that at which plants were grown. They must be planted upright and faced to give the best appearance and relationship to adjacent plants or structures. All trees must be set plumb and rigidly braced in position until the soil has been

tamped solidly around the ball. Plants must be backfilled with planting soil which must be thoroughly settled by watering and tamping to fill all voids.

All slopes must be contoured in such a manner not to exceed a 4:1 grade, especially, where trees are to be planted (refer to City Detail C-802).

#### **8.2.3.4 Transplanting**

- a. Refer to City Detail C-801 and C-806. Prepare planting area per Plant Pit Schedule detail. (If you must amend the backfill, then increase size of area and amend the entire plant pit. If you must use fertilizer in backfill, then use no more than three pounds per inch of trunk diameter of a low nitrogen, slow release fertilizer).
- b. Dig planting hole in center of area no deeper than root ball. Make sure root ball will rest on undisturbed, firm soil and that the top will be at or slightly above the soil surface. This is important to prevent the tree from sinking
- c. Remove the tree from the container. Avoid lifting the tree by its trunk (better to sacrifice the container). Either disentangle and spread encircling roots or cut and remove them. Score the sides of the root ball to encourage lateral root growth.
- d. Place tree in hole and backfill with unamended soil. Do not tamp backfill with your feet.
- e. Remove nursery stakes. Stake tree as required.
- f. If irrigating by hose, then form a well just outside the original ball root. Irrigate tree. Water will settle the soil without compaction.
- g. Apply a CarbonizPN soil enhancer, Mirimichi Green, or approved equal to all new plantings in reclaimed water areas.

#### **8.2.3.5 Nomenclature – Plant Identification**

For inspection and identification, durable legible labels, stating in weather-resistant ink, the correct plant name and size, as specified in the plant list, must be securely attached to a tree leader branch to all trees delivered and to an adequate representative amount of the shrubs to the site.

#### **8.2.3.6 Clean-Up**

Any soil, manure, or other material dropped onto paved areas by hauling operations or otherwise, must be removed promptly, keeping these areas clean at all times. Upon completion of planting, all excess soil, stones, and debris not heretofore disposed of under this scope of work, must be removed from the site or disposed of as directed by the City Representative.

#### **8.2.3.7 Maintenance Period**

The Developer or Contractor must maintain all plants for a period of ninety (90) days beginning with the preliminary acceptance by the User Department, as specified above. If all plants are not healthy at the end of the maintenance period, the maintenance must be continued until the plants meet the approval of the City, and/or are replaced.

The Developer or Contractor must guarantee all plant material to be in a vigorous, healthy condition for a period of one year from the date of final acceptance or replacement and must guarantee to replace any plant material which proves to be not true to name, regardless of the length of time it takes to make this determination. With consent of the City Streets Superintendent replacement planting may be delayed so the appropriate planting season may be utilized.

#### **8.2.4 Inert Materials**

##### **8.2.4.1 Rock and Cover**

Rock ground covers are considered to be any boulder, rock, stone, or aggregate material used to cover landscape area soil surfaces. Decomposed or crushed granite is the recommended rock ground cover material for use within City of Chandler right-of-way landscape areas. Rock ground covers must provide a minimum depth of twice the rock size specification or 2 ½", whichever is greater uniform depth after settlement. Color, gradation, aggregate size and required installation depth of rock ground cover material must be approved by the City Representative. Recommended color range is gold or tan. Other color selections will require prior approval and will be reviewed on a case-by-case basis. Typically utilized is 1 ¼" screened Desert Gold or approved equal.

##### **8.2.4.2 Installation Maintenance**

All rock ground cover areas must be sprayed with pre-emergent herbicide, by a licensed applicator, as part of installation as follows (a minimum of three applications are required):

- 1st - Prior to the application of the rock ground cover - one-half gallon per acre.
- 2nd - After rock ground cover has been applied - one-half gallon per acre.
- 3rd - Prior to final acceptance - one gallon per acre.

The City must be furnished, for approval, written documentation of applicators license, all materials used, application rates, and the scheduled dates for application prior to the start of any applications (Spray Logs).

#### **8.2.5 Turf Grasses/Lawn**

##### **8.2.5.1 Preparation of Seed Bed**

Although sod is preferred, where soil analyses show that existing topsoil is satisfactory, a seedbed must be prepared by scarifying to a depth of at least 3 inches and dragging to a smooth surface. Where existing soil is caliche type, it must be excavated to a depth of 6 inches, removed from the site and replaced with acceptable topsoil. Irregularities in the surface must be leveled before seeding operations begin.

After raking, roll the entire area in two directions at approximate right angles with a water ballast roller weighing one-hundred to three-hundred pounds. Any irregularities that develop must be re-raked, scarified for bond, and again rolled until the area is true and uniform and free from lumps or depressions. Water must be applied to surface whenever



necessary to insure proper working of soil. No heavy objects except lawn rollers must be taken over these areas. Grade and compaction must be approved by the City prior to planting.

#### **8.2.5.2 Planting**

Just prior to broadcasting the seed, apply and lightly rake into the surface the following:

- a. 5 pounds Ammonium Sulfate (21-0-0) per 1,000 square feet
- b. 15 pounds Superphosphate (0-20-0) per 1,000 square feet

After approval of the User Department of the areas to be seeded, the seed will be broadcasted at the rate of three and one-half pounds Bermuda per 1,000 square feet. One-half of the seed will be sown with the sower moving at right angles to the first sowing. Broadcasting must not be done in windy weather.

Hydro seed and sodding are approved methods of turf planting. Preparation of the turf area must follow the above guidelines.

#### **8.2.5.3 Turf Mulching**

Top dress all seeded areas with an approved organic mulch as specified. Spread mulch evenly over all areas at a rate of one cubic yard per 1,000 square feet or as recommended by the manufacturer, whichever is greater.

Lightly roll all areas and thoroughly water with a fine spray. Turf must be kept continually moist by watering as often as required without creating runoff.

Any areas that do not root properly must be replanted at ten-day intervals until an acceptable stand of grass is obtained.

#### **8.2.5.4 Maintenance Period**

The Developer or Contractor must maintain all turf areas for a period of ninety days, beginning immediately after preliminary acceptance by the City.

If all plantings are not acceptable at the end of the maintenance period, the maintenance period must be continued until the work meets approval by the User Department.

During the maintenance period, two applications of complete fertilizer (6:10:4) must be made (at 30 days and 60 days) at the rate of 20 pounds per 1,000 square feet with each application. The User Department must be furnished with written documentation of the schedule of applications.

Maintenance must include continuous operations of watering, weeding, mowing, rolling, trimming, edging, cultivating, fertilizing, spraying, insect and pest control, re-seeding, replacement, and/or other operations necessary to assure good normal growth. The Developer or Contractor will be responsible for applying lawn with control sprays or other materials, as often as may be required to protect turfs during the entire contract.

When the turf has established sufficient root structure and an approximate height of 3 inches, mowing should begin immediately to a 2-inch height and must be mowed thereafter and reduced in safe increments to a height as specified by the City.

During the installation period and during the maintenance period, the Developer or Contractor will be responsible for maintaining adequate protection for all areas. Any damaged planting must be repaired and/or replaced at the Developer's or Contractor's expense.

At termination of each maintenance period all turf must be alive, healthy, undamaged, and free of infestations. All areas must be completely covered at the time of acceptance, leaving no bare spots larger than 3 inches by 3 inches. Inferior plantings must be replaced and brought to a satisfactory condition before final acceptance of work will be made.

The Developer or Contractor must immediately replace any and all turf that dies or is damaged. Replacements must be made to same specifications as required for original plantings.

Two inspections must be made that affect each maintenance period: The first, after all planting have been completely installed, in order to approve the beginning of the maintenance period of not less than 90 calendar days; and the second, at the end of the ninety-day period. Should there be defective maintenance during the maintenance period, the maintenance period must be continued by the Developer or Contractor until all work meets the specifications and can be approved.

The Developer or Contractor must operate and maintain the irrigation system during the maintenance period. Repairing broken mainlines, pumps, laterals, sprinkler heads, emitter systems, valves and timers, and/or other malfunctions that may occur.

The Developer or Contractor must notify the City three weeks in advance of the end of his maintenance period and must also transfer title to the City prior to the City's assuming the maintenance.

### **8.2.6 Soil Testing**

All areas in which planting is to be done must have soil analyses performed to determine the soil deficiency and the nutrients needed to sustain and insure healthy plant growth. Any landscape areas suspected of having been exposed to or treated with soil sterilants or materials detrimental to plant health must be tested for the presence of toxic substances. If found, all soil with the toxic substances must be removed prior to the start of any landscape planting or irrigation system installations.

All soil testing must be completed and approved by a State of Arizona certified soils testing laboratory to meet the requirements for topsoil or fill and be free of any toxic, hazardous, or undesirable substances. The Public Works & Utilities, Streets Division must receive a copy of all tests prior to final acceptance.

### **8.2.7 Moisture Content**

The soils must not be worked when the moisture content is so great that excess compaction will occur; nor when it is so dry that a dust will form in the air or that clods will not break readily. Water must be applied if necessary, to provide optimum moisture content for tilling and for planting.

### **8.2.8 Topsoil**

All areas to be graded (cuts or fills) must be stripped of the topsoil, which must be stockpiled in an approved area. The Developer or Contractor will be responsible for making arrangements for storage and/or moving of this topsoil prior to its replacement on the site.

### **8.2.9 Finish Grading**

Upon acceptance of the subgrades by the User Department, the stockpiled topsoil must be evenly spread over the entire graded area and dragged to uniform planes at proper grades. Sprinkler and utility trenches must be dug, completed, and backfilled prior to the next segment of work. All grades must be within a tolerance of 0.10 feet; and 0.25 feet in sloping or mounded areas.

All areas to be sodded or seeded must be fine graded and topsoiled. All turf areas must be dragged and raked, removing all clods or rock, 1-inch or larger in any dimension. All soil must be thoroughly water settled.

Finish grade landscape areas (top of turf or decomposed granite) must be graded to 1 ½" below top of concrete or other paved surfaces.

Positive drainage from curb cut-outs, backs of scuppers and transitions from ends of spillways to landscape or turf area must adequately convey drainage following finish grade and landscape installation.

### **8.2.10 Utilities and Irrigations Systems**

Utilities (underground or above ground) must be located in accordance with the above referenced City Supplements. However, all new utility installations or modifications to existing utility locations should be assessed and reviewed with the Public Works & Utilities Department to determine if adjustments to the above standards may provide more appropriate placement of utilities that may otherwise restrict, prohibit, or be in conflict with desired landscape improvements. Utilities should not be located directly in the center of medians. Utilities, if required within median areas, should be offset to avoid conflicts with tree planting pit excavations and root growth. Early identification and coordination of engineering and landscape design requirements will provide a greater opportunity to initiate modifications and adjustments to allow both to be successfully integrated into the design.

Irrigation sleeves will be required under roadway, sidewalk, pavement, and pavers.

Both reclaimed and potable irrigation system water main connections, booster pumps, and backflow prevention units for the median landscape must be located within the landscape

median when possible. Center each unit equal distance between the curbs. This equipment should be no closer than 2 feet from the back of curb and should be located in an area of the median or boulevard strip that is the least noticeable by the traveling public. Backflow preventors are not required when associated with reclaimed water.

Some utilities require the electrical meter to be located in the rights of way (not in the median).

If backflow prevention units and irrigation controllers cannot be located within the median landscape areas, each unit must be located as far back of curb and walkway as possible while remaining within the right-of-way. Minimum setback distance for above ground irrigation installations from any walkway or curb edge must be 2 feet.

The location and position of irrigation system backflow prevention units, controllers, meter pedestals, and related enclosures must not conflict with vehicular sight visibility.

Landscape plant material and irrigation system components must be selected and located to maintain all required access, clearances, and setbacks adjacent to utility installations. This must be coordinated by the Design Professional and verified by the Developer and/or Contractor with the utility companies prior to any installation.

No trees should be installed adjacent to or beneath overhead utility lines if the mature growth habit of the plant will conflict with the overhead lines or restrict utility service access. Plant material must comply with approved planting lists of the associated utility if required.

### **8.2.11 Irrigation Systems**

Flood irrigation is not permitted. An automatic sprinkler irrigation system must be used for all developed areas. However, there are certain areas which should be considered 'grandfathered' and flood irrigation may be utilized with permission.

The User Department will review and approve all irrigation systems prior to any installation. All sprinkler systems must be automatic and must utilize a reduced pressure backflow preventor (per City Detail C-311) before the electric control valves. All applicable codes must be adhered to and a permit will be required. All plans submitted for approval must specify the brand, model, and nozzle size(s) of the heads. The brand, model, and size of all electric valves; and also the brand and model number of the electric controller, the brand, model, and size of the backflow preventor. Also to be submitted are all the pertinent data on such miscellaneous items as valve boxes, covers, size and type of pipe. In addition to all the necessary details, and friction pressure loss calculation for the longest run in the system for both full circle circuits and part circle circuits (see City Detail C-816). The City will furnish the Developer or Contractor with City water pressure data on request.

All mainlines, valves, and wire must be located as close as possible to the back of the right-of-way, or optionally behind the sidewalk. Irrigation within medians must be located at the center line.

All new irrigation systems serving City Owned R.O.W., medians, and retention basins must utilize potable water. Generally, modifications to existing irrigation systems must follow this approach.

- a. Reclaimed Water Served – system may typically be modified keeping reclaimed.
- b. Potable Water Served – system may be modified keeping potable water.

Coordinate with City Transportation Manager for all changes to irrigation systems owned and operated by City of Chandler.

#### **8.2.11.1 Irrigation and Design Considerations**

All irrigation equipment and installations must be in accordance with types, materials and standard details approved by the City of Chandler.

#### **8.2.11.2 Irrigation System Layout and Location**

All irrigation system mainlines, valves, wire and other primary system components or equipment must be located within the right-of-way median landscape area or as close as possible to the outer edge of the right-of-way.

Landscape irrigation systems must be designed so that irrigation to trees and palms operate on a separate valve from shrubs and ground cover varieties.

#### **8.2.11.3 Irrigation System Type/Materials/Equipment**

The City must review and approve the irrigation system and materials prior to installation. All irrigation must comply with the requirements of this Section with the following inclusions:

Irrigation system power sources must be approved by the User Department and the utility company having jurisdiction. Irrigation controllers with lockable enclosures for the median landscape will be necessary and located in the median near the backflow preventor or booster pump system.

All controllers must be equipped with a plug-type harness for a remote control attachment. Wiring must correspond to the geographic location of the valve and station controlled. The coordination of wiring systems must be approved by the City, prior to the final acceptance.

For right-of-way and median irrigation systems only rigid type P.V.C materials must be used, with bubbler or drip emitter heads. Hard pipe to riser-maximum length of drip tubing is 6 feet.

For right-of-way and median irrigation systems only rigid type P.V.C. or schedule 80 flex hose riser materials must be used, with bubbler, drip or spray type heads. Use of poly pipe is prohibited. Poly or vinyl emitter (“spaghetti”) tubing in conjunction with multi-outlet emitters is prohibited. Poly tubing must have limited use in the initial and temporary distribution of water at tree installations and must be used only in conjunction with single-outlet emitters. All horizontal installations of poly tubing must be installed and anchored a minimum of 4 inches below the finished landscape area surface.

All irrigation heads (emitters, bubblers, sprays) must be rigid “hard” plastic, ½-inch diameter threaded/screw on type installation unless otherwise approved by the City Landscape Maintenance & Design Coordinator.

Driplines must be virgin vinyl, 7510 polyethylene material as manufactured by Landscape Products or approved equal.

**8.2.11.4 Excavations, Backfilling, and Compaction**

Irrigation trenching must be per City Detail C-811 and in accordance with MAG Sections 440 and 601.

**8.2.11.5 Existing Utilities and Structures**

The Contractor must protect existing structures and utility services and be made responsible for their replacement. Minor adjustments in the system will be permitted to clear existing obstructions subject to the approval of the City.

**8.2.11.6 Watering Cycle**

Complete watering cycle for turf areas and shrub emitters, must be completed within 8 hours. Any drip system must be completed within four hours after the turf areas are completed.

Minimum water application rate per week, for Bermuda must not be less than 0.75 inches and not more than 2.75 inches per week.

Length of watering cycle and application rate per week must be noted on sprinkler irrigation plans.

**8.2.11.7 Water for Trees**

All trees must receive water from one of the following systems. Trees must be on separate valve:

- a. An emitter system with electric solenoid valve, Y-strainer and pressure regulating valve.
- b. For palms, a bubbler system with electric solenoid valve, PVC pipe with bubbler installed (see City Details C-812 and C-817).

**8.2.11.8 Sprinkler Heads**

The following manufacturers and models are acceptable:

- a. Rainbird model: 4” pop-ups
- b. Hunter: Institutional Series
- c. Bowsmith Multiport Emitters

All heads of a particular type of function in the system must be of the same manufacturer and must be marked with the manufacturer’s name and identification in such a position that they can be identified without being removed from the system. All sprinkler heads, which

are to be installed in lawn areas where the turf has not yet been established, must use a rotor dam or be set 1-inch above the proposed finished grade. Heads installed in this manner will be lowered to grade when the turf is sufficiently established to allow walking on it without appreciable destruction. All nozzles on rotary pop-up sprinklers must be tightened after installation. All sprinklers having an adjustment stem must be adjusted on a lateral line for the proper radius, diameter, and/or gallons. Two vandal resistant screwdrivers must be supplied to the City (see City Detail C-813).

All sprinklers and quick coupler valves must be installed on swing joints, consisting of two lengths of PVC schedule 80 nipples (6-inch long) attached with two PVC street ells (mipt by fipt) and one PVC ell (fipt by fipt) with a minimum of 30 degrees and a maximum arc of 60 degrees (see City Details C-813 through C-815). Pre-manufactured swing joints can also be used. Swing riser must be Dow 7510 material per Landscape Products Inc. or approved equal.

#### **8.2.11.9 Pipe**

All pipe (PVC and Copper) must be properly sized on the drawings.

No galvanized pipe may be used. Schedule 80 PVC nipples must be used for sprinkler swing joints and Type K hard copper must be used for all main line piping above grade, and extending a minimum of 18 inches and a maximum of 24 inches below finished grade.

Plastic PVC lines below street, street pavers, or sidewalk paving must be installed within separate Schedule 40 sleeves. For PVC lines 1" to 2 1/2" the sleeve must be two nominal sizes larger. For PVC lines 3" and larger the sleeve must be one nominal size larger. Sleeves for water lines must not exceed manufacturers recommended deflection for encased water line.

All pipe (PVC or Copper) installed in rocky or caliche soils must be thoroughly embedded and completely covered in sand or approved imported topsoil.

Plastic pipe must be as described on the drawings. It must be unplasticized PVC extruded from virgin parent materials of the type specified on the plans. The pipe must be homogeneous throughout and free from visible cracks, holes, foreign materials, blisters, deleterious wrinkles, and dents.

All pipe must be continuously and permanently marked with the following information: Manufacturers name, size, schedule, type of pipe, working pressure at 73 degrees Fahrenheit, and N.I.S.F. approval.

#### **8.2.11.10 Plastic Pipe, Fittings, and Connections on Mains**

All pipe and fittings must be approved type 1, grade 1, PVC, PR 200 pipe conforming to A.S.T.M. D1784-65T and D2241-L65T, and must be either solvent weld pipe or rubber ring joint pipe. When a connection is plastic to copper either a PVC Schedule 80 nipple or male



adapters must be used. The male adapter must be hand tightened, plus one turn with a strap wrench. Joint compound must be virgin teflon paste or tape.

#### **8.2.11.11 Plastic Pipe, Fittings, and Connections on Laterals**

All pipe must be as follows:

- a. ½-inch - PR 315, PVC
- b. ¾-inch and 1-inch - PR 200, SDR 21, PVC
- c. 1¼-inch and up - PR 160, SDR 26, PVC

All fittings must be molded fittings manufactured of the same materials as the pipe and must be suitable for either solvent weld or screwed connections. Use male adapters as described above. Only Schedule 80 PVC pipe may be threaded.

#### **8.2.11.12 Installation of Plastic Pipe**

Plastic pipe must be installed in a manner so as to provide for expansion and contraction as recommended by the manufacturer. Plastic pipe must be cut with a hack saw or approved cutting device or in such a manner so as to ensure a square cut. Burrs at cut ends must be removed prior to installation so that a smooth, unprotected flow will be obtained. A PVC primer must be used on all main lines (according to manufacturer's recommendations). Pipe for use with rubber gaskets must use a gasket lube, Weld On 787 or approved equal and must be tapered as recommended by the manufacturer.

#### **8.2.11.13 Drip Systems**

A drip system must be installed in such a manner that the emitters and smaller tubing are to be below grade and vandal resistant. Maximum tubing length must be 5 ft. Tubing must be buried 4 in below finish grade.

For installation, type and number of drip emitters required, refer to City Details C-808 and C-817.

Tubing must be 100% Dow Chemical 7510 polyethylene material as manufactured by Landscape Products, Inc. or approved equal.

#### **8.2.11.14 Inspections**

The User Department will inspect and approve the work at the following stages of completion. Any work completed without these inspections must be removed prior to acceptance of that phase of work. These stages are:

- a. Completion of all trenching and installation of all main lines prior to back-filling, including the backflow preventor, quick couplers, electric valves and any isolation valves. The main line must be pressure tested for 30 minutes at this inspection.
- b. Completion of installation of all control wires prior to back filling.
- c. Installation of all lateral valves, lines, and heads prior to back filling.

Prior to any construction or utility work starting within a City right-of-way, which will affect existing City-owned and maintained landscaping or irrigation systems, there will be a meeting on site to show that the existing systems or landscaped areas are in proper repair and functioning. At the completion of the construction work there will be another meeting and inspection on site. The same areas and systems will again be reviewed.

Any damage to the landscaping or to the irrigation system will be the responsibility of the general contractor or utility company and must be repaired to the satisfaction of the City within five working days. If this work is not completed within the allotted time, the City will make the repairs or corrections and money will be deducted or billed to the general contractor on the project. The individuals who should be represented at these on-site meetings must be: a representative from the Contractor, a representative from the engineering firm and a representative from the City Streets Division.

#### **8.2.11.15 Flushing and Testing**

After all new sprinkler piping and risers are in place and connected and all necessary division work has been completed and prior to the installation of sprinkler heads, control valves must be opened and a full head of water used to flush out the system. After the system is thoroughly flushed, risers must be capped off and the system pressure tested prior to backfilling the laterals.

#### **8.2.11.16 Irrigation System Maintenance**

The Developer or Contractor must maintain irrigation system for a period of ninety days, beginning immediately after preliminary acceptance by the City.

#### **8.2.11.17 Backflow Prevention**

Backflow prevention assembly must be per City Detail C-311 for potable water irrigation systems and C-404 for reclaimed water irrigation systems.

Upstream piping from the backflow prevention assembly must be flushed in a manner that will not lodge dirt, rocks, and debris in the assembly itself.

Prior to final acceptance of the irrigation systems, each backflow prevention assembly must be tested by a certified and approved backflow prevention assembly tester, to ensure the device is operating correctly within manufacturers recommendations. A list of approved testers may be obtained from the City. Test reports must be sent to the City's Water Quality Division, Public Works & Utilities Department. An approved test report form may be obtained from the City.

Those devices not meeting test requirements must be repaired and re-tested prior to final acceptance. In the case where reduced pressure principle assemblies are used, a splash pad must be used under the relief part for discharge water. An acceptable method of handling discharge water from the device must also be approved prior to the installation of such a device.

#### **8.2.11.18 Electric Controllers**

The sprinkler controller must be capable of operating on 117 volts, 60 cycle A.C. current and must provide output current of 24-26.5 volts at 1.1 amps for electric solenoid valves. Controller must be mounted on a stainless steel pedestal. Controller must be sized to perform the sprinkling efficiently and adequately. All controllers must be installed with rechargeable batteries.

The following manufacturers and models are acceptable: Irritrol, Hunter. The Irritrol IBOC Plus series battery operated clock is to be used if no booster pump is required i.e. where no electricity is required.

Wiring must correspond to the geographic location of the valve and station controlled and must be identified.

#### **8.2.11.19 Control Cable**

All wiring to be used for connection of the automatic controller to the electric solenoid actuated remote control valves must be equivalent to Type UF-600V, 7 strand or solid copper, PVC insulation, single conductor, UL approved underground feeder cable. All pilot or hot wires are to be one color and all “common” wires are to be white. Wiring must conform to local codes and must be installed according to the manufacturer’s recommendations. Minimum wire size must be No. 14. All wire connections must be made with an epoxy filled cylinder type wire connector.

#### **8.2.11.20 Remote Control Valves and Valve Boxes**

Remote control valves must be normally closed 24 volt a.c. 60 cycle solenoid actuated globe/angle pattern diaphragm type. The valve body and bonnet must be constructed of heavy duty glass-filled nylon. Solenoid coil must be encapsulated in molded epoxy. The valve must have a flow control stem with wheel handle for regulation or shutting off the flow of water and a bleed screw for manual operation without electronically energizing the solenoid. The valve construction and installation must be such as to provide for all internal parts to be removable from the top of the valve. The valve must be either Rainbird, Hunter, or approved equal and must be installed per manufacturer’s recommendations (see City Details C-809 and C-810). Ball valve isolation valve, the same size as electric valve should be installed before each electric valve.

Valve boxes must be vandal and water proof with locking bolt lid.

#### **8.2.11.21 Valve Requirements**

##### **A. Brass Ball Valve**

Must have forged brass body, threaded cap, blowout proof stem, reinforced glass fiber filled PTFE seats, quarter turn handle, NPT threaded or soldier joint ends.

Every electric remote control valve must have one ball valve on the pressure side as an isolation valve. Ball valve to be the same size as the electric remote control valve (see City Details C-809 and C-810).

## **B. Check Valves**

Check valves 2-inch and smaller must be swing type, bronze bodied with threaded connections and replaceable composition disc, rated at 150 pounds S.W.P.

Check valves 2½-inch and larger must be swing type, iron body, bronze mounted with flanged or threaded connections and replaceable rubber disc, rated at 125 pounds S.W.P.

## **C. Master Valve – Flow Sensor**

Each facility will have a master valve and flow sensor located directly after backflow device. Master valve can be same product as stated in Section 2.11.17, above. Flow meter must consist of data industrial 220 or 250 model transmitter along with 600-10 converter module. Bermad 910-P hydrometer can also be used.

### **8.2.11.22 Booster Pumps**

Booster pumps may be required, refer to City Technical Design Manual No. 1&2, Reclaimed Water Distribution System regarding pressure considerations.

Booster pumps must be located in the median if possible, if not, the booster pumps should be located near the back of the right of way in an area approved by the User Department. Electric service will be required to be supplied to the pump location. The booster pump must be installed in a marine grade aluminum enclosure. Refer to City Detail C-404. The User Department will assist in the selection of an acceptable booster pump; currently the recommended pump is manufactured by Barrett Engineered Pumps. The color of the enclosure must be acceptable to the City Landscape Maintenance & Design Coordinator. The enclosure and irrigation controller cabinet must not be located within sight visibility triangles.

## **8.2.12 Operation and Maintenance Manual**

An Operation and Maintenance Manual must be provided when the City is to assume maintenance. The Manual must include, but is not limited to the following:

- a. One Cover Page with the projects name, address, phone number, contractor, and the consultant.
- b. A Table of Contents.
- c. Information on the make, model(s), and operation of all controllers, valves, pumps, backflow preventors, sprinkler heads, bubblers, emitters, etc.
- d. Meter serial number, street addresses and account numbers.
- e. Information on the location of each station.
- f. A facility information form specifying the following information for each turf station:
  - i. Station Number
  - ii. Type of Sprinkler Heads
  - iii. Nozzle Size(s)
  - iv. GPM per Sprinkler Head(s)
  - v. Spacing between Sprinkler Head(s)

- vi. Numbers of Heads
- vii. Is the station located on a slope and what is the exposure?
- g. Information and delivery on any extra stock to be given to the City.
- h. Information and documentation on all warranties of parts and accessories.
- i. A list of all plant materials which must include the following:
  - i. Botanical Name
  - ii. Common Name
  - iii. Tree standard (Single Stem, Multi-Trunk, etc.)
  - iv. Plant Size/Container type
  - v. Quantity
  - vi. Type of irrigation to the plant (bubbler, emitter, etc.)
  - vii. How many cycles per week to water for both winter and summer?
  - viii. Length of watering per cycle
- j. Square footage of all granite areas.
- k. Square footage of all turf areas.
- l. Linear footage of header and specification
- m. Spray Logs
- n. Material Safety Data Sheets (MSDS), if requested.
- o. Irrigation Logs meeting the City requirements must be completed and be within every City controller.
- p. Information on the utilization or reclaimed or potable water.

### **8.2.13 Street Lighting and Accent Lighting**

Coordinate landscaping to avoid conflicts with street and pedestrian light poles, wiring, conduit and illumination patterns.

The Design Professional must coordinate the location of the street light conduit/cable as necessary to provide adequate clearance for required tree installations.

Up lighting of palms and trees in certain situations may be required.

Electrical outlets for seasonal lighting or other uses must be provided near up-light trees and at other selected locations as determined by the City Streets Superintendent.

Decorative and accent lighting must not be designed or installed within the right-of-way without approval from the City Streets Superintendent.

### **8.2.14 Fences/Walls or Other Structures**

Unless approved by the City Streets Superintendent, walls, fences, signs or other screening or decorative type structures will not be installed within the limits of right-of-way.

Landscape areas within a City maintained area are to have a separate irrigation system meeting City standards. Note that in some cases, for example, the opposite side of the wall

is to have a separate irrigation system if it is to be maintained by any other entity besides a City department.

### **8.3 ADDITIONAL SPECIFICATIONS FOR CITY OWNED RETENTION BASINS**

#### **8.3.1 Design Considerations**

Turf coverage or seed mix coverage will be reviewed on an individual basis with the major determinants being aesthetics, reclaimed water availability, and use. Authorization must be obtained from the City when planting of any kind is to be utilized in areas to be maintained by the City.

**Paved Pedestrian and Bicycle Ways:** Must be included when applicable to provide easy access to schools, parks, shopping, and places where people congregate. The walkways must be 6-foot minimal width.

Although the required storage volume is the primary design consideration, the contour of the basin may be irregular in nature allowing the embankment areas to become integral components of the design. A vacillating contour at areas immediately adjacent to long runs of masonry wall will be encouraged as a design detail for added depth and variety of perspective.

Basins that are landscaped are to be so designed to permit vehicular access for maintenance. Non-vehicular access will only be permitted with the City's approval. Vehicles must be able to reach the basin bottom and all basin structures. Temporary basins do not require vehicular access.

Embankments must not exceed a 4:1 ratio at lawn areas. Specific approval may be given for increased sloping in cases where the increase results in a more pleasing design and does not hamper the maintenance or the functional use of the basin. All instances of increased sloping must include the following considerations:

- a. Public Safety
- b. Low Maintenance and Maintenance Access
- c. Erosion Control
- d. Transitional Control (walls, bollards, timbers)
- e. Irrigation Runoff into ROW
- f. Environmental Regulations
- g. Elimination of Standing Water
- h. Ease of mowing and scalping prevention
- i. Safety and accessibility

Low maintenance should be an essential consideration to all design schemes, including the following:

- a. Plant material must not be placed at areas where it will encroach onto sidewalks or adjacent planting beds.

- b. Areas of varying composition within the basin, such as where ground cover or planting beds are adjacent to lawn, must be separated through the use of durable, reinforced concrete or masonry mow strips.
- c. Areas where “nuisance” water enters and/or accumulates in the basin will have design features to eliminate perpetual soggy condition and littered appearance. A dry well or French drain must be required under certain conditions as deemed necessary by the City to reduce the nuisance water problems.
- d. Positive drainage from curb cut-outs backs of scuppers and transitions from ends of spillways to landscape or turf areas must be included in design. The design should assure positive flows to inlets, drywells, etc.
- e. Generally, consideration must be given for the longer-term look of the basin in association with maintenance. For example, riprap tends to be unsightly and is a maintenance issue, so its use should be kept to a minimum.
- f. All basins must be sloped to drain.

All basins are required to provide a dust-controlling cover. All permanent basins are required to provide vegetated and mulched landscaped areas

Vehicular ramps for maintenance activities must be provided where basin slopes exceed 4:1. All vegetated landscaped basins to be maintained by the City are to provide for maintenance vehicle access.

### **8.3.2 Grading and Mounding**

All finished grades must be in accordance with approved Grading Plans. All slopes must be in accordance with the approved Grading Plan and the top and bottom of all slopes must be rounded for a distance of not less than 10 feet.

All fills must be compacted to 85% density in 8-inch lifts and brought to optimum moisture content and thoroughly compacted. All rock 1-inch or larger in any dimension, debris, rubbish, concrete, or asphalt paving must be removed from the site prior to preparing the finished subgrade.

All cuts must be made in accordance with the plans. All cut areas must be over-excavated to guarantee the replacement of a 6-inch thick layer of topsoil when turf is specified, or the required mulch depth if required.

Positive drainage from curb cut-outs backs of scuppers and transitions from ends of spillways to landscape or turf areas must be graded to convey drainage. Grading must convey runoff away from the roadway, or existing hardscape, including walls.

### **8.3.3 Drywells**

Drywells must be registered with the ADEQ (US EPA during primacy application interim period) in the name of the underlying property owner at the completion of construction. Percolation testing, drilling logs, and registration numbers must be delivered to City at the time of project acceptance.



### 8.3.4 Plant Materials

Quantities stated here are not intended to be absolute numbers, but rather “rule of thumb” for the Design Professional and reviewer.

Basin designs will be evaluated on an individual basis, considering quality of design and environmental contribution to the community. Strong considerations must be given to ease of maintenance; all designs for permanent basins require the use of low water use landscape material.

Tree Material - The minimum allowable number of trees in a basin must be established at the rate of 20 per acre, or at a rate otherwise approved by the Public Works & Utilities Department.

One species will account for about 40 percent of the tree material. The nature of the basin and design concept will dictate a mix of tree species. A mix of acceptable, larger species is encouraged. The Mix of tree sizes must be about 50 percent 36-inch box or larger, 40 percent 24-inch box, and 10 percent 15 gallon, or at a mix of tree sizes otherwise approved by the Public Works & Utilities Department.

Consideration must be given to each landscaped area to provide a site feature to that area. The feature, to be approved by the City may include; specimen plant material, hardscape elements (bench, protective rails, boulders) or other features.

When specifying plant material, be cognizant of the space available in contrast to the mature size of the plant species to reduce both hazards and maintenance issues.

Be selective where grafted trees are utilized due to seasonal wind issues.

### 8.3.5 Lawn Construction Materials

Lawn construction must be one of the following:

- a. **Winter Lawns** (not permitted unless authorized by the City Streets Superintendent) - Must be sodded with a (insert sod spec) sod. At the Developer’s or Contractor’s option, they may wait until April 15 and seed Bermuda grass.
- b. **Summer Lawns** - Must be sodded blend of predominately Bermuda Primayera (Cynondon Dactylon) planted from April 15 through October 15; or with permission from the City Streets Superintendent must be fancy hulled seed having minimum percentage of purity and germination of 94 percent and 88 percent respectively and a weed seed content not exceeding 0.35 percent. The Bermuda seed must comply with requirements noted in this chapter. The amount of seed must be based on the application rate specified in subsection 8-B. The seed must be sown prior to final acceptance.

#### 8.3.5.1 Mulch

This is typically 2.5” minimum depth screened 1 ¼” Desert Gold decomposed granite or approved equal on all areas of medians, permanent basins and on basin tops and banks with

the bottom being compacted earth decomposed granite or approved equal on Temporary basins. Variations may occur with the permission of the City Streets Superintendent.

### **8.3.5.2 Header**

Unless already separated by a hardscape feature or edge (ie, sidewalk, driveway, structure) all turf areas are to be separated from other areas, typically granite mulch, by a header. Prior approval may be granted for other types of headers, but typically they should be 6" wide, reinforced concrete.

A minimum 6' separation (buffer) is required from walls and turf edged by a reinforced concrete header. The buffer typically consists of decomposed granite mulch, shrubs and ground cover as specified. The intent is to keep spray heads away from walls.

## **8.4 ADDITIONAL SPECIFICATIONS FOR RIGHTS-OF-WAY AND MEDIANS**

### **8.4.1 General**

When the Design Professional is designing a right-of-way landscaping system that is adjacent to an existing or previously approved plan, the proposed plan must be compatible with the existing landscaping plan yet meeting current Code requirements and standards. If the Engineer does not desire to continue the existing plan or the City does not desire it to be continued, the Landscape Architect or Engineer must design a transitional area to change from the existing to the new type of landscaping.

The Design Professional, in designing the right-of-way landscaping, must take into consideration any potential conflict between the trees the Design Professional proposes and existing or planned utility lines. This must be coordinated by the Developer or Contractor with the utility companies.

Community or commercial development gateways and entry features are important to the image and awareness of the particular development and should be considered an integral part of the overall design of the streetscape. Right-of-way designs should be coordinated to insure compatibility and a unified appearance between gateway/entry features and the streetscape.

All right-of-way landscape and irrigation system installations to be maintained by the City must be located entirely within the limits of the right-of-way. There must be no overlap between public and privately maintained systems without prior approval and written authorization from the Public Works & Utilities Department.

Generally, the landscape maintenance of the boulevard strip, the area between the back of curb (or edge of paved roadway) and the right-of-way must be maintained by the adjacent development, property owner or homeowners association.

Where publicly maintained and privately maintained landscape areas abut each other, a method of separation must be provided to establish clear limits of maintenance responsibility. Acceptable methods for providing separation between public and private

landscape areas must be as follows: walls, fences, walkways or reinforced concrete headers (plastic or wood headers are typically not allowed). Metal or plastic headers (only if required by a utility) may be utilized if approved by the City representative.

#### **8.4.1.1 Streetscape**

In general, the term streetscape refers to the many visible surface elements that make up a typical roadway environment. However, due to the fact that many of the visible elements are directly affected by the requirements of their below grade portion or the requirements of other elements located below ground, the Design Professional must consider both the surface and sub-surface elements as part of the total streetscape. Typical streetscape elements include vehicular and pedestrian pavements, surface and sub-surface utilities, grading and drainage, lighting, walls, signage, and landscaping.

#### **8.4.1.2 Streetscape Character/Image**

Streetscapes are the signature feature of various developments throughout the City of Chandler. From the major highways to residential streets, the visible streetscape establishes an image or character of the community for both residents and visitors. A well-coordinated and unified streetscape will not only enhance the visual quality of the community but will also provide a continuity and help to improve the image and character of the overall City. Although not always aware of it, the general public is influenced by the aesthetic appeal provided by streetscape design as well as how it supports or fits the vision of their City.

Streetscape design should consider the local context of the roadway as well as unique features and focal points of the community areas. Streetscape design can be beneficial toward the enhancement of the positive aspects of the City.

Streetscape design within public right-of-ways should consider views of the immediate streetscape from the perspective of the vehicle and pedestrian users as well as views between the roadway and the adjacent development. Distant views of scenic or significant features should be maintained or enhanced whenever possible.

### **8.4.2 Design Guidelines**

#### **8.4.2.1 Tree Density for Medians**

Trees must not be planted within median landscape areas that measure less than 8 feet in width, from face-of-curb to face-of-curb without consent of the City Streets Superintendent and the City Traffic Engineer.

36" Box Tree Size Minimum or as directed by City Engineer and meeting the latest edition of the Arizona Nursery Association *Container Grown Tree Guide*.

In general, the required tree density formula for median landscape areas must be as follows:

- a. The minimum required tree density for all median landscape areas greater than 8 feet wide and equal to or less than 16 feet wide, face-of-curb to face-of-curb, must be determined at a ratio of one tree per 30 feet of plantable median length.

Medians greater than 16 feet in width will require increased tree densities and evaluated on a case by case basis per the City Landscape Maintenance & Design Coordinator.

- b. In addition to the minimum required tree density of one tree per 30 feet of plantable median length, an additional one-third of the required minimum total must be added within the portion(s) of the median landscape area outside the vehicular sight distance/visibility clear zone.
- c. The desired location for increased median tree densities is within the permanent portion(s) of phased median landscape areas, outside vehicular sight distance/visibility clear zones. However, the City Landscape Maintenance & Design Coordinator may approve tree locations in the temporary portions of the phased medians outside of the vehicular sight distance/visibility clear zones.
- d. If any portion of the permanent and/or temporary portion(s) of phased median landscape areas are within vehicular sight distance/visibility clear zone the Design Professional must show these areas on the plan(s) at the time of the first City of Chandler review submittal.
- e. At the time of the first submittal review, the City of Chandler may exercise the option to modify the tree density requirements, which may result in the addition or deletion of trees.
- f. Trees within median may be uniformly spaced or planted in random groupings as long as the density ratio criteria indicated above is correct for the full length of the median improvements and as long as the maximum spacing between trees does not exceed 200'. The minimum spacing for trees must not be less than one-half of the mature canopy spread of each of the two adjoining trees. Actual plant placement and planting patterns must be determined by the Design Professional and submitted to the City for review and approval.

#### **8.4.2.2 *Tree Density for Boulevard Strip Frontages***

In general, the required tree density formula for the boulevard strip frontage (face of outside curb to the right-of-way) must be as follows:

- a. The required minimum density of trees for boulevard strip areas from 10 feet up to 25 feet wide, must be determined at ratio of one tree per 30 linear feet of curb frontage length. Boulevard strips greater than 25 feet in width will require increased tree densities and must be evaluated on a case by case basis by the City Landscape Maintenance & Design Coordinator. Boulevard strips less than 10 feet in width must be evaluated on a case by case basis by the City Landscape Maintenance & Design Coordinator.
- b. The required formula for increasing tree densities within the boulevard strip areas greater than 25 feet wide must be one tree per 800 square feet.
- c. Trees within the boulevard strip may be uniformly spaced or planted in random groupings as long as the density ratio criteria indicated above is correct for the full length of the improvements and as long as the maximum spacing between trees

does not exceed 200'. The minimum spacing for trees must not be less than one-half of the mature canopy spread of each of the two adjoining trees. Actual plant placement and planting patterns must be determined by the Design Professional and submitted to the City for review and approval.

#### **8.4.2.3 Ground cover and Shrub Density for Median and Right-of-Way Frontages**

Ground cover plants and shrubs at maturity must provide 40% minimum coverage of the total available landscape surface area for permanent median and boulevard strip areas. Within certain City areas, which include but are not limited to gateways, Downtown, and the Mall, minimum densities may be increased at the discretion of the City Streets Superintendent.

Ground cover plants and shrubs at maturity must provide 30% minimum coverage of the total available landscape surface area for temporary median and boulevard strip areas unless otherwise approved by the City Streets Superintendent.

#### **8.4.2.4 Plant Species Variations**

There must be a minimum of 2 and a maximum of 5 different tree species/varieties and a minimum of 3 and a maximum of 12 different shrub/ground cover species/varieties required per design area. The City prefers an abundance of seasonal color in its landscape plantings utilizing diverse species. Other plant species variations may be allowed pending review and approval of the City Landscape Maintenance & Design Coordinator.

### **8.4.3 Planting of Trees, Shrubs, and Ground Cover**

All trees must be located so the center line of the tree trunk is at least 8 feet behind the back of the curb, at least 5 feet from the nearest edge of sidewalk and at least 2 feet from the fence installed along the property line (for all right-of-way areas of sufficient size to allow trees). There must be a minimum of one tree per 40 linear feet of right-of-way area. A minimum of two different varieties and a maximum of five different varieties will be required.

All planting of trees, shrubs, and ground cover must comply with the requirements of Section 8.2 of this chapter. All plant material used in right-of-way and median landscaping must be approved by the Director of Public Works & Utilities. Some materials appearing on the plant list will not be acceptable for the use in these areas.

#### **8.4.3.1 Grading and Drainage**

Aesthetic grading and land form design (mounding and depressions) of boulevard strip areas and medians may be used to provide visual relief, and control surface drainage. Offset or meandering wall alignments in combination with contoured land-form design is also recommended.

Aesthetic grading or land-form surface variations greater than 6 inches within boulevard strip and median landscape areas less than 8 feet in width is not recommended. For areas 8 feet or greater in width, aesthetic grading and land-form design is recommended. Cut or depressed slopes and fill or elevated slopes must be constructed in accordance with the

engineering requirements. Slopes should be no steeper than 4:1 (H:V). Fill areas should be compacted between 85% and 90% in 8-inch maximum lifts.

Upon completion of site grading, underground utilities and landscape irrigation system installations, the entire site must be fine graded by dragging and raking to remove all clods and rocks 1-inch and larger. All landscape area soil must be water settled and compacted to required densities. Prior to any planting, an inspection must be requested and completed by the User Department. All grades must be kept within a tolerance of 1/10-foot, plus or minus in landscape areas. Where installation of topsoil is specified or shown on the drawings, topsoil must be installed at a minimum depth of 18 inches (refer to City Detail C-807).

All areas must be sloped to drain. Ponding of water must be prevented. Grades must slope away from walls and other features which may be damaged by water.

Design Professionals should attempt to balance earthwork requirements between cut and fill whenever possible to avoid importing and exporting requirements.

All imported soil must be thoroughly tested and approved by a State of Arizona certified soils testing laboratory to meet the requirements for topsoil and be free of any toxic, hazardous, or undesirable substances.

#### **8.4.3.2 Safety Considerations**

Safety must be an integral part of all public right-of-way design, including streetscape improvements. Streetscape design must consider the safety of all right-of-way users from vehicular and bicycle to pedestrian and maintenance personnel. Because many of the landscape elements that make up the streetscape are not constant, the Design Professional must be aware of how the various elements will change and how these changes will affect the relationship between the streetscape elements and the users.

#### **8.4.3.3 Vehicular/Pedestrian Sight Distance, Visibility Clear Zones**

The following referenced detail and sight distance regulations are with regard to vehicular visibility and safety. The sight distance standards provided herein may not be applicable to every intersection or vehicular sight distance condition. Each vehicular sight distance must be evaluated on an individual basis due to the multiple site specific conditions and roadway geometric factors that may vary at any location. The information contained herein is based on 90 degree intersections, flat (vertical alignment) and straight (horizontal alignment) roadway conditions. Variations in design speeds and posted speed limits, roadway elevation changes, alignment skews and curves or various other conditions are but a few of the factors that may significantly alter required sight distance criteria and visibility clear zones.

Sight distance criteria and visibility clear zones must pertain to all classifications of roadway intersections and driveways with access onto any public roadway.

Refer to City of Chandler Standard Sight Distance Details C-246, C-247 and C-248.



All trees within vehicular sight distance/visibility clear zones must have a vertical canopy clearance/clear trunk to 6 feet above the nearest top of curb or sidewalk elevation. Trees with growth characteristics such as low branching or multiple trunks may require larger size specimens to be installed to provide the required canopy clearance, or increased tree spacing distances will be necessary to ensure adequate sight visibility is provided and maintained. Trees within vehicular sight distance visibility clear zones must be horizontally spaced and/or offset to prevent creation of a “picket fence effect” based on the angle and position of the viewer from the origin point of the vehicular sight distance. Minimum or maximum tree spacing requirements previously indicated may require modifications as a result of actual roadway and sight distance/visibility clear zone conditions or tree size and growth characteristics.

Visibility obstruction by all other landscape elements, other than trees, within vehicular sight distance clear zones must not exceed 2 feet in height. In other words, no single or combination of shrubs and ground cover plant material, inert ground cover materials or elevated land-form, within vehicular sight distance visibility clear zones, must exceed 2 feet in height above the nearest vehicular pavement top of curb or sidewalk elevation (when fully matured).

The above limits of sight distance visibility obstruction must provide a minimum 4-foot vertical visibility window between the 2-foot maximum visibility obstruction height and below the 6-foot minimum canopy clearance/obstruction height.

The sight distance visibility of any on-road vehicle, within the 4-foot vertical visibility window, may not be obstructed more than 25% at any time. In other words, within the 4-foot vertical visibility window, 75% of any moving vehicle profile must be visible at all times from the origin point of any sight distance position or potential conflicting intersection turning movement.

Irrigation equipment installations are required to be sized and located to avoid conflicting with sight distance visibility clear zones. Irrigation equipment or equipment enclosure installations must not exceed 2-foot maximum height above the nearest vehicular pavement curb unless located outside the sight visibility clear zone.

#### **8.4.3.4 Landscape Setbacks/Clearances**

Plant material setbacks as indicated below must be adhered to for the safety of the public, maintenance personnel and maintenance operations.

All the trunks within median landscape areas should maintain a minimum 6-foot horizontal setback from face-of-curb and in no cases be less than 4 feet from the face of any permanent or future curb.

Within public right-of-ways, the use of plant materials that have thorns, rigid pointed blades or needles are not recommended. Use of plants with sharp protrusions must be restricted to areas where the mature natural growth pattern of the plant (mature horizontal spread



and/or vertical canopy clearance) will remain a minimum of 3 feet from any pedestrian surface or bicycle lane.

All plant material must be located to prevent encroachment of normal growth patterns into pedestrian or vehicular circulation areas and sight distance clear zones.

All shrub and ground cover plantings must maintain a minimum 1-foot setback from walkways and back-of-curbs at maturity. For medians, maintain a minimum of 2-foot setback from back-of-curb at maturity.

Trees must be selected and located to provide adequate vertical canopy clearance above pedestrian or vehicular circulation areas as follows: 8 feet minimum above pedestrian walkways and 13'-6" minimum clearance above vehicular traffic.

All trees must be located so the center line of the tree trunk is a minimum of 5 feet from walls or fences.

The location and position of any plant materials must not obstruct visibility of or restrict maintenance access to any signage or traffic control devices.

All plant materials must be selected and arranged to meet the above setback and clear zone requirements without maintenance. Some tree species may require occasional pruning to encourage strong growth and maintain the required sight distance clear zones and setbacks.

#### **8.4.3.5 *Phased Roadway/Temporary Medians***

Phased major arterial roadways in the City of Chandler will typically have an initial median width that includes 24 feet of additional width (refer to City Detail C-204). The additional width is considered to be the requirement for the expansion of two future 12-foot traffic lanes, one on each side of the permanent landscape median area. To avoid having the future lane areas, or temporary portion of the median, appear unattractive and void of landscaping, the design must have temporary landscaping installed during the initial phase of the roadway development for the unknown interim period.

Because the landscape improvements for this area are considered temporary, the Design Professional must consider the potential impacts associated with the future lane additions, from both a construction and cost conscious standpoint. The design and installation of both the planting and irrigation system must be sensitive to the permanent portion of the median as well as the temporary portion. The Design Professional must provide an overall median design that will allow for the future removal of the outer edges while maintaining a complete and total design for the permanent portion of the median to remain. Both the planting and irrigation systems must be designed to allow for the removal of the temporary portion with little or no impact on the permanent portion. Major components of the irrigation system should not be installed in temporary median areas. The location and installation of both the temporary and permanent median landscape elements must also be designed to be in

accordance with sight distance and clear zone setback requirements for both the interim and future roadway conditions.

**8.4.4 Decorative Pavers**

In median landscape design the Design Professional must follow the dimensions and layout as shown on City Detail C-225. This requirement is mandatory at all left turn bay locations and at all other median breaks to facilitate adequate visibility for motorized vehicles.

**8.4.5 Transit Facilities**

Refer to the Regional Public Transportation Authority (RPTA) handbook and guidelines, most current edition, for landscaping transit facilities.

(Intentionally left blank)

## Chapter 9 - Survey and Vertical Control Benchmarks

### 9.1 VERTICAL CONTROL

All improvement plan elevations must be based the North American Vertical Datum of 1988 (NAVD 88). The City has an established network of Survey Benchmarks, and projects must identify the benchmark that was utilized to establish project elevations. For location and description of available benchmarks see Figure 9-A, and Table 9.1 below.

The City made the switch from the National Geodetic Vertical Datum (NGVD 29) to NAVD 88 in 2011. Care must be taken when examining record drawings to determine what datum was used and performing elevation adjustments for new construction. Table 9.1 provides a vertical offset value for each benchmark to convert from NVGD 29 to NAVD 88. The vertical datum offset value is also shown in Figure 9-A in the form of “contours” for approximate differences citywide.

Prior to disturbing any City benchmark by construction, written permission from the City must be obtained.

**Table 9.1**  
**Vertical Control Benchmark List**

BENCHMARK NO.	NGVD 29 ELEVATION	DESCRIPTION	EQUATION (Convert from NVGD 29 to NAVID 88 must add)	NAVD 88 ELEVATION
RYAN	1254.7514	Arizona Department of Highway brass cap set in concrete on bedrock down 0.1', 0.37 miles south on I-10 from the intersection of I-10 and Baseline Road, about 80' west of center of southbound lane of I-10.	2.018	1256.77
BM-F	1215.292	Maricopa County brass cap set in 8" concrete post, flush with pavement surfacing. 500' south of US 60 freeway centerline on Arizona Avenue to Iron Avenue and 500' east on Iron Avenue.		
1	1190.178	Section 21, T1S, R4E, 2" brass cap set in footing of electrical transmission tower #14, between 56th Street and Kyrene Rd., 40' east of railroad tracks; 920' north of Ray Road.	1.883	1192.06
2	1173.632	Section 28, T1S, R4E, 2" brass cap set in footing of electrical transmission tower #20 between 56th Street and Kyrene Road; 40' east of railroad tracks, 700' north of Chandler Boulevard.	1.854	1175.49

BENCHMARK NO.	NGVD 29 ELEVATION	DESCRIPTION	EQUATION (Convert from NGVD 29 to NAVD 88 must add)	NAVD 88 ELEVATION
3	1170.253	Section 27, T1S, R4E, 3" City of Chandler brass cap in concrete, flush, between Chandler Blvd and Ray Rd; 140' East of Kyrene Rd at point of curvature of Ivanhoe St.	1.854	1172.11
4	1171.558	Section 26, T1S, R4E, 3" City of Chandler brass cap in concrete, flush, between Chandler Blvd and Ray Rd; 430' East of Rural Rd at intersection of Jentilly Lane and Joshua Blvd.	1.834	1173.39
5	1174.975	Section 25, T1S, R4E, 3" City of Chandler brass cap in concrete, flush, between Chandler Blvd and Ray Rd; 250' East of McClintock Drive at intersection of Laveen Drive and Galveston Street.	1.811	1176.79
6	1176.343	Section 35, T1S, R4E, 3" City of Chandler brass cap in concrete, flush, between Chandler Blvd and Pecos Rd; 560' West of McClintock Dr at intersection of 79th St and Milky Way.	1.788	1178.13
7	1170.074	Section 34, T1S, R4E, 3" City of Chandler brass cap in concrete, flush, between Chandler Blvd and Pecos Rd; 105' west of intersection of Whitten St and Twelve Oaks Blvd at point of curvature on Whitten St.	1.798	1171.87
8	1158.756	Section 34, T1S, R4E, 3" City of Chandler brass cap in concrete, flush, between Chandler Blvd and Pecos Rd; 390' east of Kyrene Rd at intersection of Aspen Dr Chicago St.	1.818	1160.57
9	1177.972	Section 23, T1S, R4E, 3" City of Chandler brass cap in concrete, flush, between Ray Rd and Warner Rd, 190' west of McClintock Dr at intersection of Orchid Land and Adler Dr.	1.834	1179.81
10A	1184.702	Section 19, T1S, R5E, 3" City of Chandler brass cap in concrete, flush, at the intersection of Calle Del Norte & Desoto St.; 260' East of Northbound frontage road for Loop 101 and one-half mile north of Ray Road. (Northing, 846853.150 Easting, 707675.724	1.821	1186.52
11	1192.045	Section 19, T1S, R5E, 3" City of Chandler brass cap in concrete, flush, between Ray Rd and Warner Rd; 200' West of Dobson Rd at intersection of Knox Rd and Santa Anna Court. (Northing, 846754.805, Easting, 712200.083)	1.808	1193.85
12	1191.820	Section 30, T1S, R5E, 3" City of Chandler brass cap in concrete, flush, between Ray Rd and Chandler Blvd; 175' west of Dobson Rd at intersection of Salida Del Sol and Tulsa St.	1.785	1193.61

BENCHMARK NO.	NGVD 29 ELEVATION	DESCRIPTION	EQUATION (Convert from NVGD 29 to NAVID 88 must add)	NAVD 88 ELEVATION
13	1190.833	Section 31, T1S, R5E, 3" City of Chandler brass cap in concrete, flush, between Chandler Blvd and Pecos Rd; 660' west of Dobson Rd; 500' south of Frye Rd at point of curvature of 95th St.	1.762	1192.60
14	1184.453	Section 31, T1S, R5E, 3" City of Chandler brass cap in concrete, flush, between Chandler Blvd and Pecos Rd; 960' east of Price Rd and 685' south of Frye Rd at point of curvature of Bracken Lane.	1.768	1186.22
15	1187.892	Section 25, T1S, R4E, 3" City of Chandler brass cap in concrete, flush, between Chandler Blvd and Ray Rd; 1,000' west of Price Rd and 215' north of Metro Blvd at point of curvature of Federal St.	1.788	1189.68
16A	1194.570	Section 13, T1S, R4E, City of Tempe brass cap in concrete, flush, at the intersection of Research Parkway and Conference Drive in ASU Research Center Park; 600' West of southbound frontage road for Loop 101 and 2300' south of Elliott Road. (Northing, 853003.485, Easting, 706222.781)	1.854	1196.42
17	1193.513	Section 7, T1S, R5E, 2" brass cap set in base of electric transmission tower #133 between Guadalupe Rd and Elliot Rd; 150' east of northbound frontage road of Price Freeway; 90' south of canal.	1.87	1195.38
18	1197.577	Section 7, T1S, R5E, 2" brass cap set in base of electric transmission tower #127 between Guadalupe Rd and Elliot Rd; west of Dobson Rd; 90' south of canal.	1.854	1199.43
19A	1192.622	Section 17, T1S, R5E, New 3" City of Chandler brass cap in concrete, flush, between Elliot Rd and Warner Rd, 290' east of Dobson Rd at intersection of Shawnee Dr and Yucca St. (Northing, 852701.682, Easting, 712690.766)	1.834	1194.46
20	1204.484	Section 9, T1S, R5E, 2" brass cap set in base of electric transmission tower #121, between Guadalupe Rd and Elliot Rd; first tower east of Alma School Rd, 90' south of canal.	1.834	1206.32
21	1209.933	Section 10, T1S, R5E, 2" brass cap in base of electric transmission tower #115 between Guadalupe Rd and Elliot Rd, east of Arizona Ave, 90' south of canal.	1.814	1211.75

BENCHMARK NO.	NGVD 29 ELEVATION	DESCRIPTION	EQUATION (Convert from NVGD 29 to NAVID 88 must add)	NAVD 88 ELEVATION
22	1207.640	Section 16, T1S, R5E, 3" City of Chandler brass cap in concrete, flush, between Elliot Rd and Warner Rd; 450' west of Arizona Ave at point of tangency of Palomino Dr, straight north of Bldg. 8.	1.801	1209.44
23	1208.829	Section 21, T1S, R5E, 3" City of Chandler brass cap in concrete, flush, between Warner Rd and Ray Rd; 530' west of Arizona Ave at intersection of Knox Rd and Oregon St.	1.781	1210.61
24	1204.066	Section 21, T1S, R5E, 3" City of Chandler brass cap in concrete, flush, between Warner Rd and Ray Rd; 670' east of Alma School Rd at the intersection of Knox Rd and Pleasant Dr.	1.795	1205.86
25	1200.173	Section 17, T1S, R5E, 3" City of Chandler brass cap in concrete, flush, between Warner Rd and Elliot Rd; 200' west of Alma School Rd at intersection of Barrow Dr and Citation Dr.	1.821	1201.99
26	1218.884	Section 22, T1S, R5E, 3" City of Chandler brass cap in concrete, flush, between Warner Rd and Ray Rd; 450' west of McQueen Rd at intersection of Calle Del Norte and Kingston St.	1.765	1220.65
27	1224.095	Section 26, T1S, R5E, 2" brass cap set in base of most westerly ballfield light standard at Pima Park between Ray Rd and Chandler Blvd, 140' east of McQueen Rd, 390' north of Galveston St and Thatcher.	1.745	1225.84
28A	1206.534	Section 28, T1S, R5E, City of Chandler brass cap flush at the intersection of Monterey St. and Iowa St; one-half mile north of Chandler Blvd and 2100' west of Arizona Ave; (Northing, 842210.209, Easting, 720961.010)	1.768	1208.30
29	1200.659	Section 29, T1S, R5E, 3" City of Chandler brass cap in concrete, flush, between Chandler Blvd and Ray Rd; 510' west of Alma School Rd at intersection of Chippewa St and Galveston St.	1.775	1202.43
30	1225.214	Section 35, T1S, R5E, 3" City of Chandler brass cap in concrete, flush, between Chandler Blvd and Pecos Rd; 1000' east of McQueen Rd; 150' north of Frye Rd at intersection of Cindy St and Cross Creek Dr.	1.726	1226.94
31A	1213.554	Section 34, T1S, R5E, New 3" City of Chandler brass cap in concrete, flush, at the intersection of Delaware St and Frye Rd; one-half mile south of Chandler Blvd and one-quarter mile east of Arizona Ave. (Northing, 836419.005, Easting, 724282.302)	1.739	1215.29

BENCHMARK NO.	NGVD 29 ELEVATION	DESCRIPTION	EQUATION (Convert from NVGD 29 to NAVID 88 must add)	NAVD 88 ELEVATION
32	1216.807	Section 34, T1S, R5E, 2" brass cap set in rear ramp of City of Chandler Public Works Bldg. at 215 East Buffalo St; just outside in right of the rear door.	1.745	1218.55
33	1202.912	Section 32, T1S, R5E, 3" City of Chandler brass cap in concrete, flush, between Chandler Blvd and Pecos Rd; 640' west of Alma School Rd; 640' north of Frye Rd at intersection of Maggio Way and Apache Dr.	1.755	1204.67
34	1234.141	Section 36, T1S, R5E, 3" City of Chandler brass cap in concrete, flush, between Chandler Blvd and Pecos Rd; 200' east of Cooper Rd at intersection of Frye Rd and Eucalyptus Place.	1.716	1235.86
35A	1236.110	Section 36, T1S, R5E, 3" brass cap in concrete, 130' north, 50' east of intersection Cooper Rd and Pecos Rd; 10' east of back of curb. (Northing, 833981.517, Easting, 733683.658)	1.709	1237.82
35B	1232.640	Section 2, T2S, R5E, 3" City of Chandler brass cap in concrete, flush, at the intersection of Canyon Oaks Way and Derringer Way; 660' west of Cooper Rd and 280' south of Pecos Rd. (Northing, 833559.554, Easting, 732956.040)	1.709	1234.35
36A	1215.120	Section 4, T2S, R5E, 3" brass cap in concrete, 150' south, 75' west of intersection of Arizona Ave and Pecos Rd; 4' west of back of sidewalk.	1.732	1216.85
37A	1194.092	Section 32, T1S, R5E, brass cap in hand hole at the intersection of Fairview St and south entry to Chandler Hospital; 830' east of Dobson Rd, one-quarter mile north of Pecos Rd. (Northing, 835011.942, Easting, 713282.302)	1.755	1195.85
38	1181.520	Section 7, T2S, R5E, 3" brass cap in concrete, 200' east of southwest corner of Section 6, approximate intersection of Old Price Rd and Germann Rd (westerly terminus of existing roadway for Germann), 57' south of the north face of curb line. (Northing, 828007.232 Easting, 707380.141)	1.739	1183.26
39A	1207.430	Section 5, T2S, R5E, 3" brass cap in concrete, 200' north of intersection of Germann Rd and Alma School Rd; 3' west of back of sidewalk at west side of Alma School Rd. (Northing, 828448.394, Easting, 717765.451)	1.722	1209.15



BENCHMARK NO.	NGVD 29 ELEVATION	DESCRIPTION	EQUATION (Convert from NVGD 29 to NAVID 88 must add)	NAVD 88 ELEVATION
40A	1222.715	Section 10, T2S, R5E, City of Chandler brass cap in hand hole at the intersection of Tumbleweed Park Rd and Pioneer Parkway; 1300' south of Germann Rd and 700' west of McQueen Rd. (Northing 827154.945, Easting, 727632.268)	1.696	1224.41
41A	1247.715	Section 12, T2S, R5E, 3" City of Chandler brass cap in concrete, flush, at point of curvature on Stearman Dr, 300' south of Germann Rd and 1000' west of Gilbert Rd. (Northing, 828514.378, Easting, 737723.986)	1.68	1249.40
42	1237.900	Section 12, T2S, R5E, 3" City of Chandler brass cap in concrete, flush, 200' north of intersection of Queen Creek Rd and Cooper Rd; 23' east of edge of pavement. (Northing, 823412.906, Easting, 733727.263)	1.673	1239.57
43A	1213.880	Section 9, T2S, R5E, 3" brass cap in concrete, 100' north, 70' west of intersection of Arizona Ave and Queen Creek Rd; on roadside by SRP structure. (Northing, 823148.607, Easting, 723063.962)	1.693	1215.57
44A	1194.940	Section 8, T2S, R5E, 3" City of Chandler brass cap in concrete, flush, at intersection of Arroyo Dr and Hawk Court; 240' north of Queen Creek Rd and 750' East of Dobson Rd. (Northing, 823083.368, Easting, 711742.493)	1.709	1196.65
45	1182.500	Section 19, T2S, R5E, 3" City of Chandler brass cap in concrete, flush, on Old Price Rd (dirt road just west of Intel Delivery Rd); 1 mile south of Queen Creek Rd, 100' south of airport entrance, east side of road. Sign is on Intel fence. (Northing, 817273.665, Easting 707321.855) (Difficult to find and within Intel Security Boundaries)	1.693	1184.19
46A	1204.510	Section 16, T2S, R5E, 3" brass cap in concrete, 70' north, 70' east of intersection of Basha Rd and Ocotillo Rd; 4' north of back of sidewalk. (Northing, 817729.065, Easting, 717971.277)	1.68	1206.19
47A	1227.920	Section 14, T2S, R5E, 3" brass cap in concrete, 215' east of intersection of McQueen Rd and Ocotillo Rd; 4' north of back of curb. (Northing, 817836.803, Easting, 728629.500)	1.663	1229.58

BENCHMARK NO.	NGVD 29 ELEVATION	DESCRIPTION	EQUATION (Convert from NVGD 29 to NAVID 88 must add)	NAVD 88 ELEVATION
47B	1230.835	Section 23, T2S, R5E, 3" City of Chandler brass cap in concrete, flush, at the intersection of Lantana Ranch Blvd and Yellowstone Place; 1320' east of McQueen Rd and 280' south of Ocotillo Rd. (Northing, 817577.585, Easting, 729757.926)	1.66	1232.50
48	1253.940	Section 24, T2S, R5E, 3" brass cap in concrete, 200' south of intersection of Ocotillo Rd and Gilbert Rd, 14' west of edge of pavement, 3' east of concrete lined ditch. (Northing, 817836.811, Easting, 738972.720)	1.644	1255.58
49	1242.850	Section 25, T2S, R5E, 3" City of Chandler brass cap in concrete, flush, 300' east of intersection of Cooper Rd and Chandler Heights Rd, 12.5' south of edge of pavement. (Northing, 812635.984, Easting, 734038.204)	1.637	1244.49
49A	1240.361	Section 23, T2S, R5E, 3" City of Chandler brass cap in concrete, flush, at the intersection of Lynx Place and Soho Lane; 1100' north of Chandler Heights Rd, 250' west of Cooper Rd and 80' south of Blue Ridge Way. (Northing, 813789.424, Easting, 733531.105)	1.64	1242.00
50A	1209.014	Section 21, T2S, R5E, 3" City of Chandler brass cap in concrete, flush, at the point of curvature on Sunland Dr; 1200' west of Arizona Ave and 800' north of Chandler Heights Rd, across from south entry to school. (Northing, 813205.302, Easting, 721923.193)	1.66	1210.67
51A	1189.135	Section 19, T2S, R5E, City of Chandler brass cap in hand hole at the south end of Dobson Rd on the section line and Chandler Heights Rd alignment, 50' north of private gate into gated community. (Northing, 812283.369, Easting, 712419.743)	1.67	1190.81
52	1200.630	Section 28, T2S, R5E, 3" City of Chandler brass cap in concrete, flush, 225' north of intersection of Riggs Rd and Alma School Road; 5' east of top back of curb, 1' from the base of a 45 MPH speed limit sign. (Northing, 807304.830, Easting, 717944.193)	1.644	1202.27
53A	1227.040	Section 35, T2S, R5E, Aluminum cap in concrete, 250' south of Riggs Rd and 7.5' east of the back of curb, east side of McQueen Rd. (Northing, 807021.964 Easting, 728528.589)	1.627	1228.67

BENCHMARK NO.	NGVD 29 ELEVATION	DESCRIPTION	EQUATION (Convert from NVGD 29 to NAVID 88 must add)	NAVD 88 ELEVATION
54A	1251.920	Section 36, T2S, R5E, 3" brass cap in concrete 79' south, 65' west of intersection of Riggs Rd and Gilbert Rd, 2' west of back of curb. (Northing, 807359.419 Easting, 739000.867)	1.614	1253.53
55	1235.060	Section 1, T3S, R5E, 3" City of Chandler brass cap in concrete, flush, 216' east of intersection of Hunt Hwy and centerline of Cooper Rd North, 22.5' south of edge of pavement; 2' north of barbed wire fence. (Northing, 802088.583, Easting, 734034.369)	1.601	1236.66
55A	1233.902	Southeast corner of Section 35, T2S, R5E, Chandler Horizontal Control Pt. #5355, brass cap in hand hole at the intersection of Hunt Hwy & Cooper Rd. (Northing, 802118.993, Easting, -733844.085)	1.601	1235.50
56	1215.030	Section 3, T3S, R5E, 3" City of Chandler brass cap in concrete, flush. Southeast corner of Arizona Ave and Hunt Hwy, 10' south of edge of pavement. (Northing, 801860.284, Easting, 723572.960)	1.617	1216.65

(Intentionally left blank)

Figure 9-A  
Survey Benchmarks

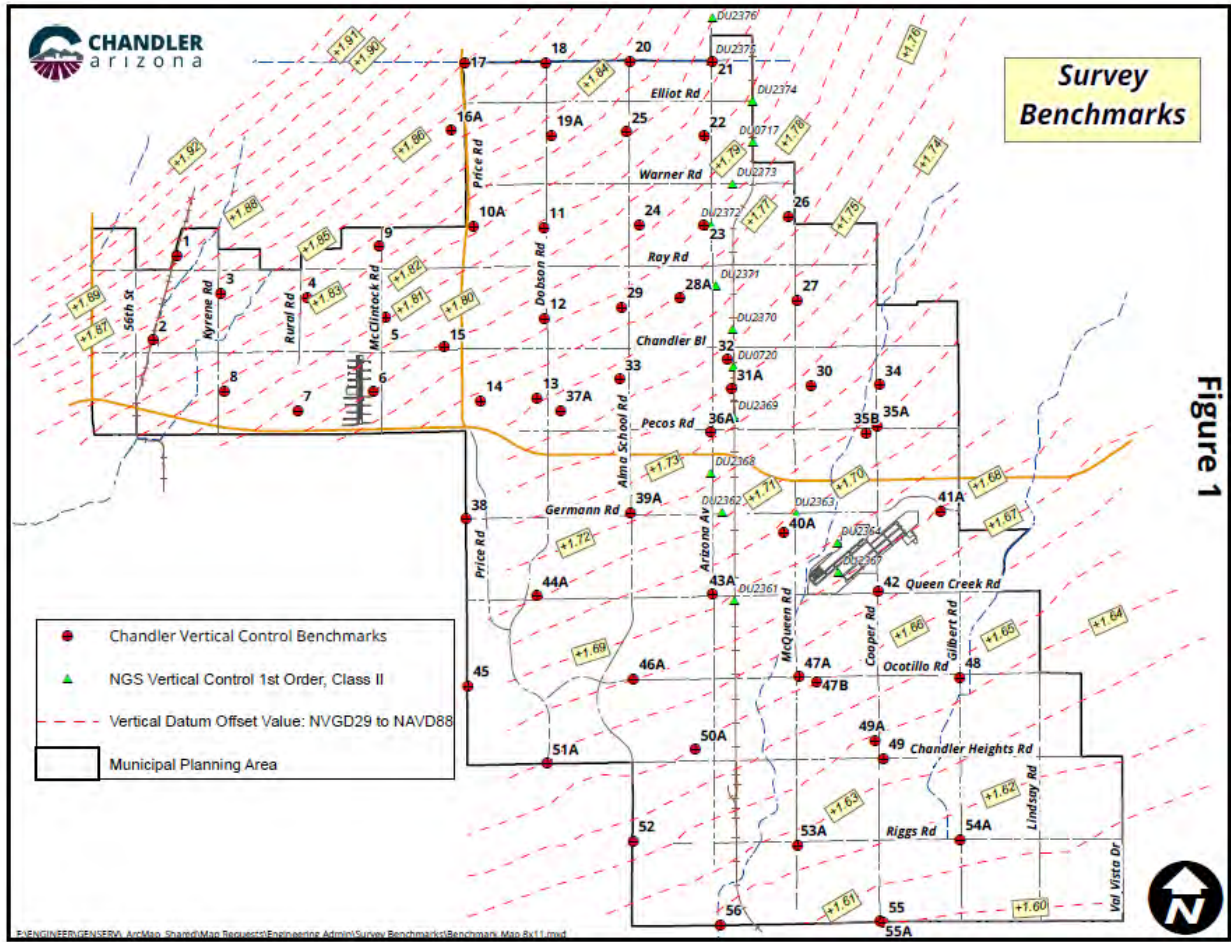


Figure 1